

DV Gas Insert (Logs) 739ILN (NG) & 739ILP (LPG) Installation and Owner's Manual

WARNING



**HOT GLASS WILL
CAUSE BURNS.**

**DO NOT TOUCH GLASS
UNTIL COOLED.**

**NEVER ALLOW CHILDREN
TO TOUCH GLASS.**

INSTALLER
Leave this manual
with the appliance.

CONSUMER
Retain this manual
for future reference.

WARNING: If the information in these instructions is not followed exactly, a fire or explosion may result causing property damage, personal injury or loss of life.

Do not store or use gasoline or other flammable vapors and liquids in the vicinity of this or any other appliance.

WHAT TO DO IF YOU SMELL GAS

- Do not try to light the appliance.
- Do not touch any electrical switch; do not use any phone in your building.
- Immediately call your gas supplier from a neighbor's phone. Follow the gas supplier's instructions.
- If you cannot reach your gas supplier, call the fire department.

Installation and service must be performed by a qualified installer, service agency or the gas supplier.

Please read this manual **BEFORE** installing and operating this appliance.

This appliance may be installed in an after-market permanently located, manufactured (mobile) home where not prohibited by local codes.

This appliance is only for use with the type of gas indicated on the rating plate. This appliance is not convertible for use with other gases, unless a certified kit is used.

This appliance is a domestic room-heating appliance. It must not be used for any other purposes such as drying clothes, etc.

This appliance is suitable for installation in a bedroom or bed sitting room.

Massachusetts: The piping and final gas connection must be performed by a licensed plumber or gas fitter in the State of Massachusetts.

Ce guide est disponible en français sur demande.

Manufactured by
MILES INDUSTRIES LTD., British Columbia, Canada
www.valorfireplaces.com

Thank You ...

For purchasing a Valor by Miles Industries. Your new radiant gas heater is a technical appliance that must be installed by a qualified dealer. Each Valor fireplace is fully tested during the production process for your safety and comfort.

Your unit has been professionally installed by:

Dealer Name _____

Phone Number _____

Should you encounter an operational problem, call your dealer immediately. Do not try to repair the unit as you may cause an injury or damage the fireplace.

The information contained in this installation manual is believed to be correct at the time of printing. Miles Industries Ltd. reserves the right to change or modify any information or specifications without notice. Miles Industries Ltd. grants no warranty, implied or stated, for the installation or maintenance of your heater, and assumes no responsibility for any consequential damage(s).



We recommend that our gas hearth products be installed and serviced by professionals who are certified in the United States by NFI (National Fireplace Institute®).

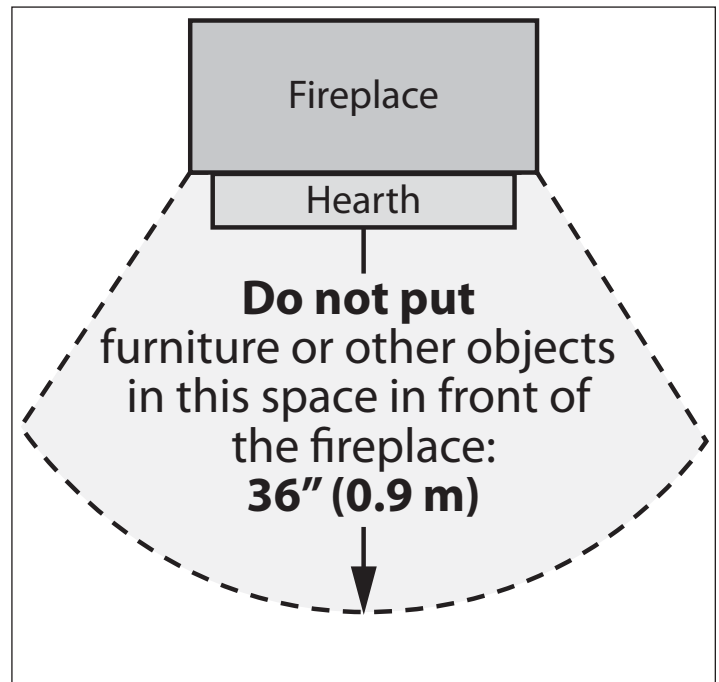

Designed and Manufactured by / for
Miles Industries Ltd.
190-2255 Dollarton Highway, North Vancouver, BC, CANADA V7H 3B1
Tel. 604-984-3496 Fax 604-984-0246
www.valorfireplaces.com
© Copyright Miles Industries Ltd., 2011.

Safety and Your Fireplace

Please Read and Carefully Follow all Safety Warnings and Operating Instructions Contained in Your Owners Manual

(Replacement Manuals are available by contacting our service department at 1-800-468-2567 or visit www.valorfireplaces.com).

Please Follow These Important Child Safety Precautions and Recommendations,

- Parts of your Valor Fireplace become **extremely hot** while in operation.
- The glass viewing **window temperature can exceed 500 F** at full capacity. Momentary contact with a hot glass surface can **cause a severe burn**, even if the fireplace is operating at reduced heating capacity.
- **The glass window will remain hot** for an extended period of time after the fireplace has been turned off. Ensure that children are prevented from touching the fireplace during the cool down period.
- **Toddlers and Young Children must be closely supervised at all times** when they are in the same room as the operating fireplace. They lack full awareness of danger and rely on your protection. Toddlers, in particular, do not have the motor skills and response reflexes to



withdraw in the event of accidental contact with a hot surface.

- **A physical barrier is strongly recommended** if there are young children, or at-risk individuals in the house. Install an approved after-market safety gate to keep toddlers, young children and other at-risk individuals a safe distance from the fireplace.
- **Keep the remote control handset out of reach of children at all times.** A wall mount storage holster is provided with your remote control handset.
- **Ensure that the fireplace, including the pilot light, is completely turned off** when children are present and close supervision and safety barriers are not available—see page 22 of *Owner's Information* section.
- If the fireplace is not going to be used for the summer or any extended period of time, **remove the batteries from the remote control handset and receiver.** It is recommended that batteries are replaced annually in any event—see page 21.

Table of Content

| | |
|---|----|
| ◇ Safety and Your Fireplace..... | 3 |
| Safety and Warning Information..... | 5 |
| Specifications | 6 |
| Overview..... | 7 |
| Dimensions | 8 |
| Cavity | 8 |
| Clearances..... | 9 |
| Venting..... | 10 |
| Installation Planning..... | 11 |
| Existing Fireplace Preparation..... | 11 |
| Appliance Preparation..... | 12 |
| Gas Supply Installation | 15 |
| Ceramic Bricks Installation..... | 16 |
| Ceramic Logs Installation | 16 |
| Window Refitting | 18 |
| Remote Control Initial Set-up | 18 |
| Operation Check & Aeration Settings Adjustment | 19 |
| Remote Control Handset Wall Holder Installation | 19 |
| ◇ Owner's Information..... | 20 |
| Remote Control Operation..... | 23 |
| Options | 26 |
| Lighting Instructions | 27 |
| Wiring Diagram | 28 |
| Venting Accessories..... | 29 |
| Warranty | 30 |
| Spare Parts..... | 31 |

◇ = Updated content

READ and **UNDERSTAND** all instructions carefully before starting the installation. **FAILURE TO FOLLOW** these installation instructions may result in possible fire hazard and will void the warranty.

Prior to the first firing of the fireplace, **READ** the Owner's Information section of this manual.

DO NOT USE this appliance if any part has been under water. Immediately, **CALL** a qualified service technician to inspect the unit and to replace any part of the control system and any gas control that has been under water.

THIS UNIT IS NOT FOR USE WITH SOLID FUEL.

Installation and repair should be **PERFORMED** by a qualified service person. The appliance and venting system should be **INSPECTED** before initial use and at least annually by a professional service person. More frequent cleaning may be required due to excessive lint from carpeting, bedding, etc. It is **IMPERATIVE** that the unit's control compartment, burner, and circulating air passageways **BE KEPT CLEAN** to provide for adequate combustion and ventilation air.

Always **KEEP** the appliance clear and free from combustible materials, gasoline, and other flammable vapors and liquids.

NEVER OBSTRUCT the flow of combustion and ventilation air. Keep the front of the appliance **CLEAR** of all obstacles and materials for servicing and proper operation.

Due to the high temperature, the appliance should be **LOCATED** out of traffic areas and away from furniture and draperies. Clothing or flammable material **SHOULD NOT BE PLACED** on or near the appliance.

Children and adults should be **ALERTED** to the hazards of high surface temperature and should **STAY AWAY** to avoid burns or clothing ignition.

YOUNG CHILDREN should be **CAREFULLY SUPERVISED** when they are in the same room as the appliance. Toddlers, young children and others may be susceptible to **ACCIDENTAL CONTACT BURNS**. A physical barrier is recommended if there are at risk individuals in the house. To restrict access to a fireplace or stove, **INSTALL AN ADJUSTABLE SAFETY GATE** to keep toddlers, young children and other at risk individuals out of the room and away from hot surfaces.

This unit **MUST** be used with a vent system as described in this installation manual. **NO OTHER** vent system or components **MAY BE USED**.

This gas fireplace and vent assembly **MUST** be vented directly to the outside and **MUST NEVER** be attached to a chimney serving a separate solid fuel burning appliance. Each gas appliance **MUST USE** a separate vent system. Common vent systems are **PROHIBITED**.

INSPECT the external vent cap on a regular basis to make sure that no debris, plants, trees, shrubs are interfering with the air flow.

The glass door assembly **MUST** be in place and sealed before the unit can be placed into safe operation.

DO NOT OPERATE this appliance with the glass door removed, cracked, or broken. Replacement of the glass door should be performed by a licensed or qualified service person. **DO NOT** strike or slam the glass door.

The glass door assembly **SHALL ONLY** be replaced as a complete unit, as supplied by the fireplace manufacturer. **NO SUBSTITUTE** material may be used.

DO NOT USE abrasive cleaners on the glass door assembly. **DO NOT ATTEMPT** to clean the glass door when it is hot.

TURN OFF the gas before servicing this appliance. It is recommended that a qualified service technician perform an appliance check-up at the beginning of each heating season.

Any safety screen or guard removed for servicing **MUST BE REPLACED** before operating this appliance.

DO NOT place furniture or any other combustible household objects within 36" of the fireplace front.

BE CAREFUL not to put any decorating objects sensitive to heat to close above or around the fireplace as it gets very hot when operating.

DO NOT use this heater as a temporary source of heat during construction.

This appliance is a **DOMESTIC ROOM-HEATING APPLIANCE**. It must not be used for any other purposes such as drying clothes, etc.

State of California. Proposition 65 Warning. Fuels used in gas, wood-burning or oil fired appliances, and the products of combustion of such fuels, contain chemicals known to the State of California to cause cancer, birth defects and other reproductive harm. California Health & Safety Code Sec. 25249.6.

Operating your fireplace for the first time

When operating your new fireplace for the first time, some vapors may be released due to the burning of curing compounds used in the manufacture of the appliance. They may cause a slight odor and could cause the flames to be the full height of the firebox, or even slightly higher, for the first few hours of operation.

It is also possible that these vapors could set off any smoke detection alarms in the immediate vicinity. These vapors are quite normal on new appliances. We recommend opening a window to vent the room. After a few hours use, the vapors will have disappeared and the flames will be at their normal height.

Specifications

Approval & Codes

This appliance is certified to ANSI Z21.88-2009 / CSA 2.33-2009 American National Standard / CSA Standard for *Vented Gas Fireplace Heaters* for use in Canada and USA, and to CGA 2.17-91 *High Altitude Standard in Canada*. This appliance is for direct vent insert installations.

This appliance complies with CSA P4.1-09 *Testing method for measuring annual fireplace efficiencies*.

The installation must conform to local codes or, in the absence of local codes, with the *National Fuel Gas Code, ANSI Z223.1* or the *Natural Gas and Propane Installation Code CAN/CGA-B149*. Only qualified licensed or trained personnel should install this appliance.

This appliance must be electrically grounded in accordance with local codes, or, in the absence of local codes, with the *National Electrical Code, ANSI/NFPA 70* or the *Canadian Electrical Code, CSA C22.1*.

Ratings

| Model | NG | LPG |
|-----------------------------------|---------------|---------|
| Gas | Natural | Propane |
| Altitude (Ft.)* | 0-4,500 feet* | |
| Input Maximum (Btu/h) | 26,000 | 24,000 |
| Input Minimum (Btu/h) | 6,500 | 13,000 |
| Manifold Pressure (in w.c.) | 3.6 | 10.0 |
| Minimum Supply Pressure (in w.c.) | 5.0 | 11.0 |
| Maximum Supply Pressure (in w.c.) | 10.0 | 14.0 |
| Main Burner Injector Marking | 82-750 | 92-260 |
| Pilot Injector Marking | 35 | 27 |
| Min. Rate By-Pass Screw | 125 | 125 |

*High Altitude Installations

Input ratings are shown in BTU per hour and are certified without deration for elevations up to 4,500 feet (1,370 m) above sea level.

For elevations above 4,500 feet (1,370 m) in USA, installations must be in accordance with the current ANSI Z223.1 and/or local codes having jurisdiction. Heating value of gas in some areas is reduced to compensate for elevation—consult your local gas utility to confirm.

For installations at elevations above 4,500 feet (1,370 m) in Canada, please consult provincial and/or local authorities having jurisdiction.

Supply Gas

Heater engine 739ILN is used with natural gas.

Heater engine 739ILP is used with propane gas.

The supply pressure must be between the limits shown in the Ratings section above.

The supply connection is 3/8" NPT female and located on the left hand side of the control valve. The gas line entry point is on the left hand side on the fireplace.

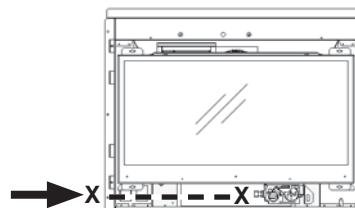

Conversion Kits

The 739IL Legend G3 is supplied as natural gas or propane gas and is field convertible between fuels. See instructions packaged with the conversion kit for further information.

Electrical

The 739 does not require an electrical power source to operate as a heater. However, if the appliance is fitted with a fan, a grounded power source is required.

This appliance may ONLY be installed in an existing unaltered, functioning solid-fuel burning fireplace with a working flue and constructed of non-combustible material.

DO NOT install into combustible construction. This appliance is NOT APPROVED for installation with a zero clearance kit.

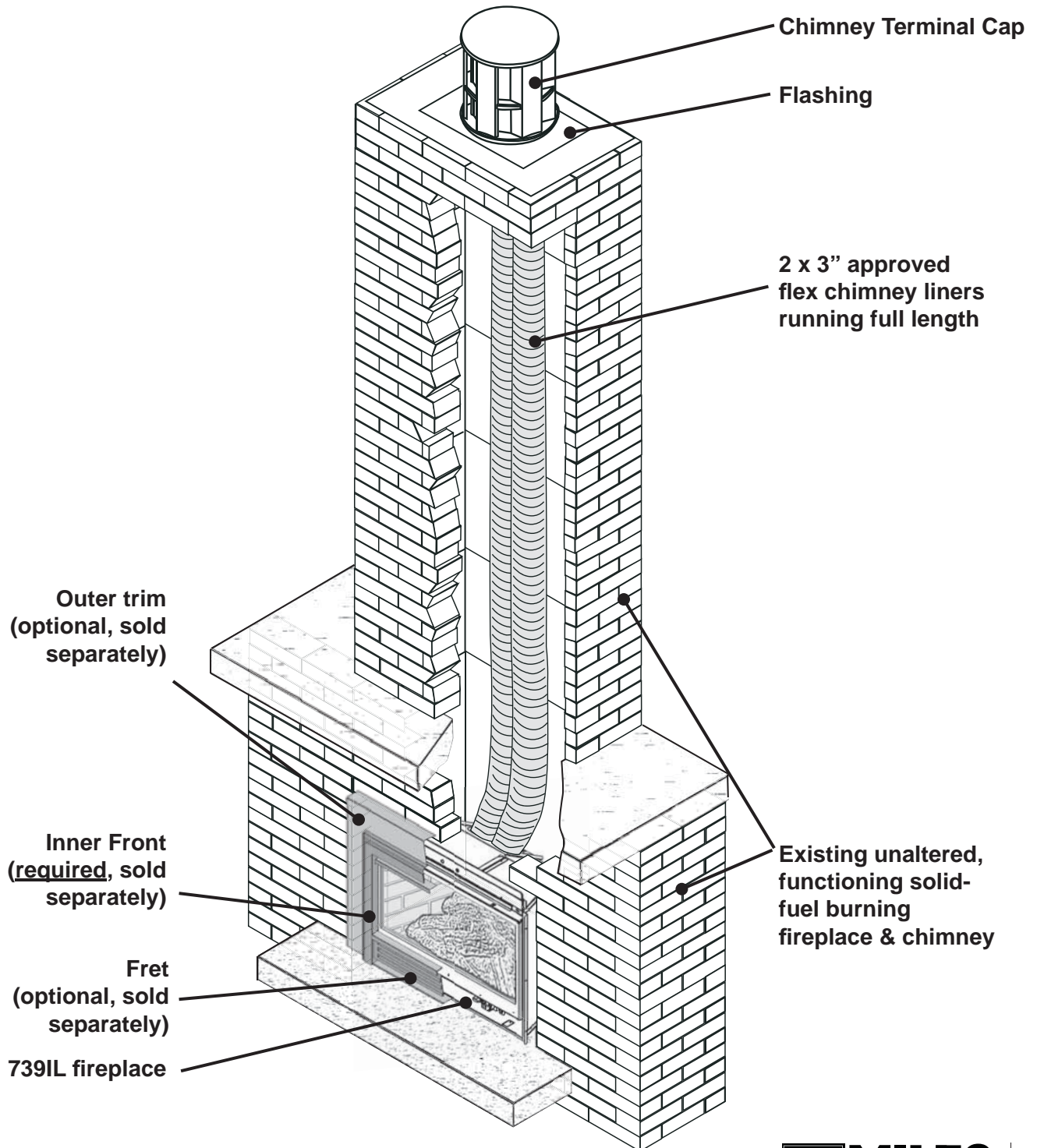

Dimensions

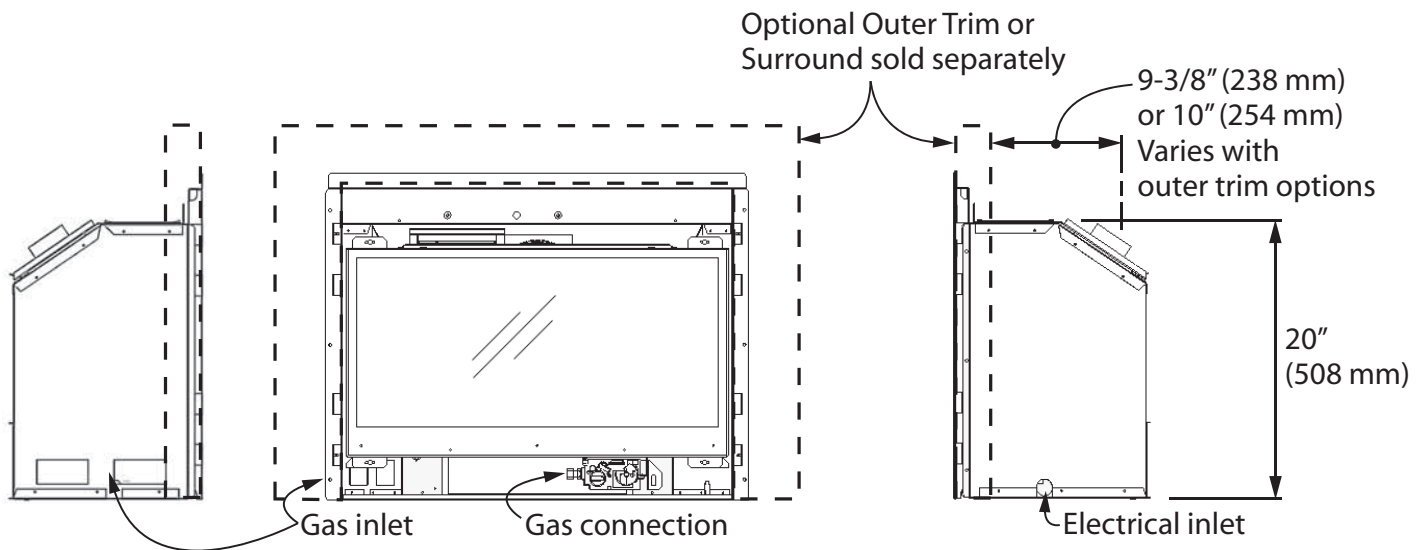
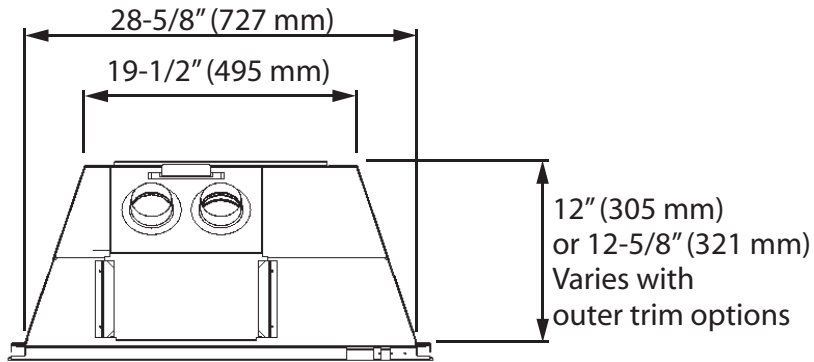

Cavity

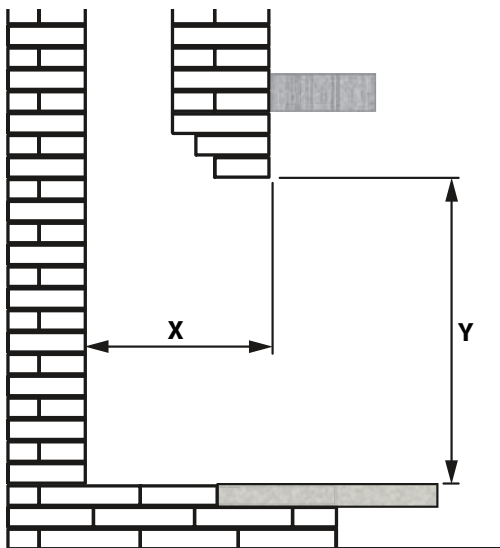

Check that masonry step does not interfere with install dimensions or vent pipe.

If mantel is combustible, see section *Clearances* for allowable clearances.

Minimum width of fireplace opening at front: 28" (711 mm)

X = 12" (305 mm) or 12-5/8" (321 mm)—varies with outer trim options
 Y = 20" (508 mm)

WARNING

Some materials or items, although safe, may discolor, warp, crack, peel, and so on because of the heat produced by the fireplace. Avoid placing candles, paintings, photos, and other items sensitive to heat around the fireplace.

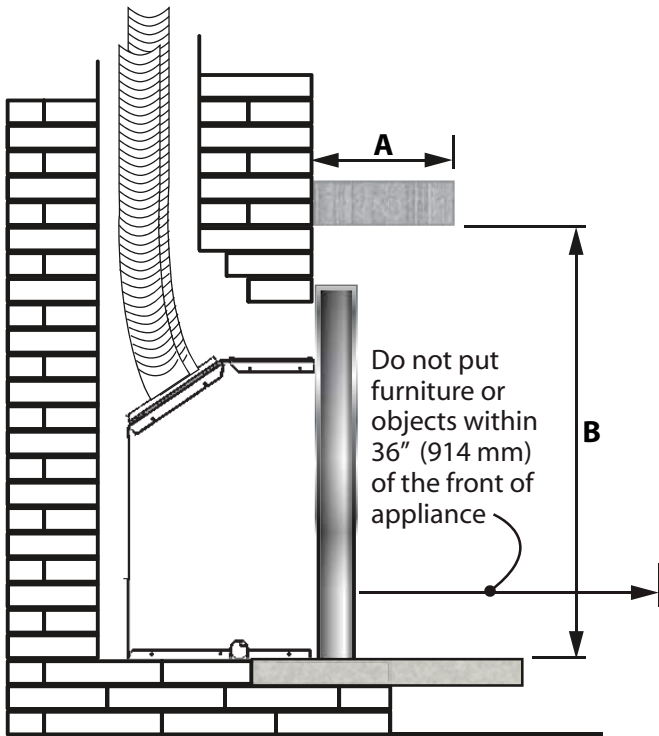

Combustible Mantel Clearances

| | | | | |
|----------------------------|-----------------|-----------------|-----------------|-----------------|
| Mantel Projection A | 1" (25 mm) | 4" (101 mm) | 8" (203 mm) | 14" (355 mm) |
| Mantel Height B* | 28" (711 mm) | 32" (813 mm) | 35" (889 mm) | 38" (965 mm) |

*Measure taken from the underside of the mantel to finished hearth or surface that the unit is sitting on.

Finishing Materials

Combustible materials: Material such as wood, compressed paper, plant fibers, plastics or any material capable of igniting and burning, whether flame-proofed or not, plastered or un-plastered.

Non-combustible materials: Material such as steel, iron brick, tile, concrete or materials that bear the UL mark for zero (0) fire rating.

WARNING

HOT GLASS! The use of a screen in front of the glass is highly recommended particularly in households with children.

WARNING

HOT HEARTH! The hearth in front of the fireplace becomes very hot when the fireplace heats. Do not use the hearth as a seat or shelf.

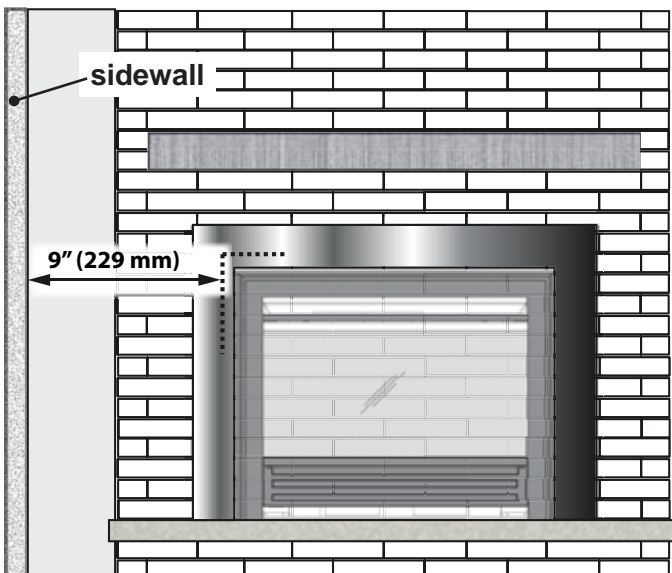

Sidewall Clearances

Minimum distance from side of appliance (liner box) to combustible wall: 9" (229 mm).

Typical Vent Installation

See list of approved Venting Accessories on page 29 of this manual.

Vent Location

The vent terminal must be located through the roof. This direct vent appliance is designed to operate when an undisturbed airflow hits the outside vent terminal from any direction. Check local codes for allowable vertical vent termination.

Venting Table

| | |
|-------------------------|---|
| Maximum vertical height | 40 ft (measured to bottom of termination) |
| Minimum vertical height | 10 ft (measured to bottom of termination) |
| Maximum horizontal run | 4 ft (measured center to center of pipe) |
| Maximum offset angle | 45° (sweeping bend to allow for obstructions) |

Venting Notes

Where possible, avoid joining flex pipes. If joints are required, use a approved connector and seal joints with *RTV high temp sealant*. Horizontal offset is permissible to allow for routing around masonry projections. Avoid bending flex pipe over a 45 degrees radius where possible.

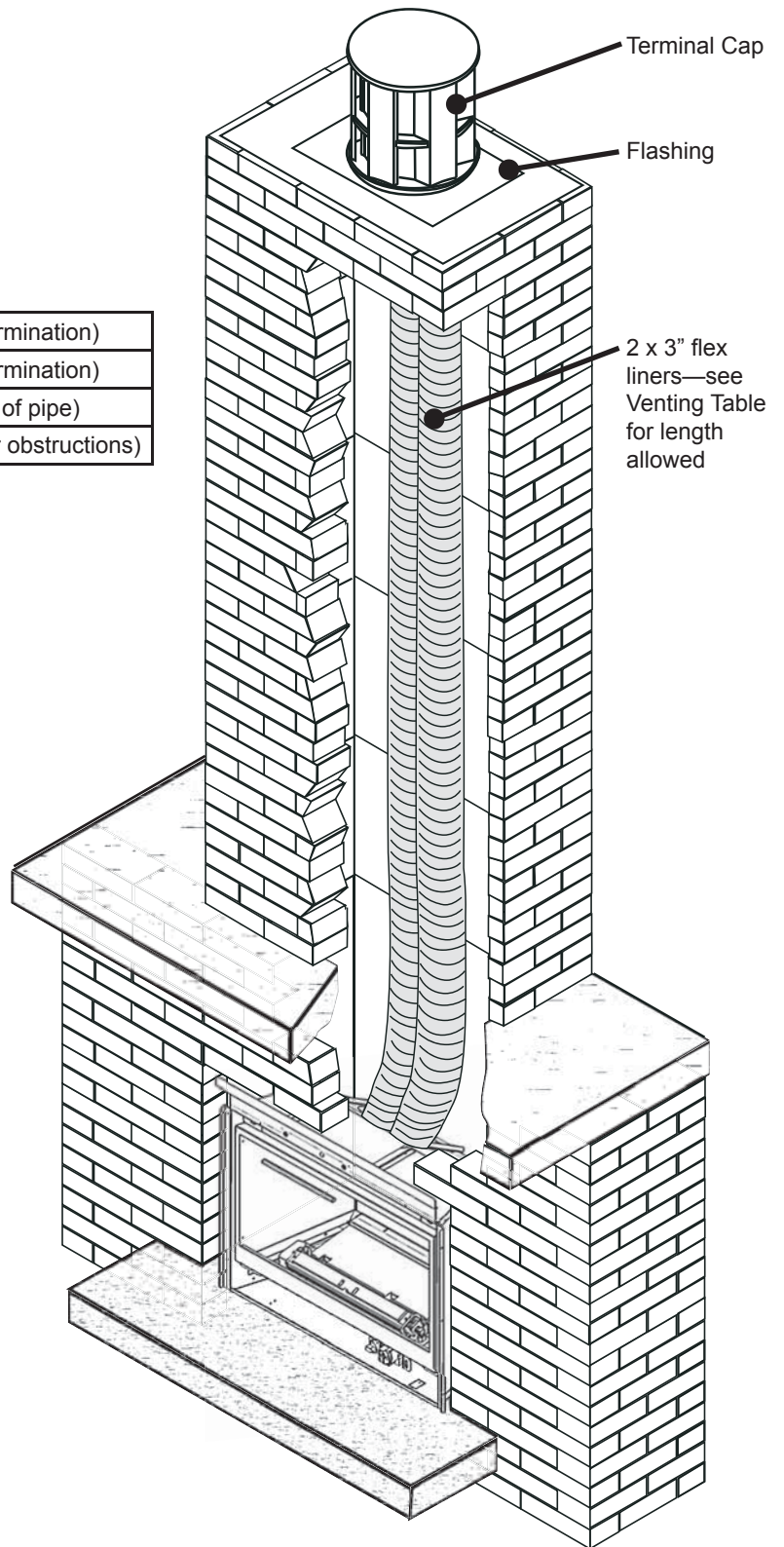
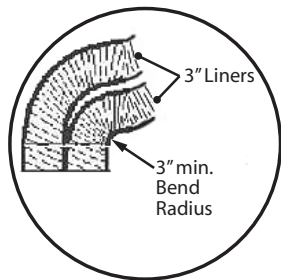

Installer—READ THIS FIRST

1. **YOU NEED TO KNOW FROM THE HOMEOWNER what accessories (surround, door, etc.) will be installed with this fireplace;**
2. Unpack the appliance.
3. Check that you have everything.
4. Clean cavity, chimney, ash dump, and clean-out.
5. Install venting pipes.
6. Attach conversion plate to existing fireplace.
7. Install and test blower if used.
8. Fit appliance into cavity.
9. Connect and test gas supply.
10. Install bricks and logs.
11. Refit window.
12. Put batteries in receiver and remote control handset.
13. Set-up remote control.
14. Connect electrical wiring blower if used.
15. Verify operation and adjust aeration settings.
16. Install the remote control handset wall holder.
17. **Instruct the homeowner on the operation and maintenance of the fireplace.**
18. Install the surround trim and front.
19. Install the fret if required.

Tools and supplies required

- Packing knife
- Screwdriver set
- Pliers
- Adjustable Wrench
- Sealant
- Dish soap/water solution
- Gloves
- Eye Protection
- Electric outlet if installing a blower

Existing Fireplace Preparation

A few points must be considered before inserting the 739IL into an existing fireplace cavity. Generally, no modifications are allowed to the existing fireplace that will compromise the integrity of the existing fireplace. Components that are bolted or screwed on such as dampers or baffles may be removed to accommodate the installation of the 739IL engine. **Cutting away any sheet metal parts of the existing fireplace to accommodate the installation of the 739IL is prohibited.** Check with local authorities if in doubt.

Clean Fireplace and Chimney

Have the chimney swept and the fireplace cavity including ash dumps and clean-outs cleaned before installing the 739IL heater and vent liners. Any creosote or soot residue remaining in the fireplace cavity chimney or clean-out may cause odors or stains once the 739IL insert is installed. Consult with chimney sweep for information on how best to clean.

Existing Dampers

Factory-built, zero-clearance fireplaces will require the damper to be removed in order to install the vent liners. These dampers are usually bolted into place. Dampers in masonry fireplaces must be fixed open and may remain in place.

Ash Retaining Curbs

Some fireplaces (particularly factory-built) have a raised curb at the front edge to retain ashes. Check the dimensions carefully to ensure the 739IL engine will fit behind any raised curb (some curbs may be removed separately from the refractory base).

Gas Line Routing

Plan the routing of the gas line before proceeding. Utilize the existing hole for the gas line of the factory-built fireplace. If the fireplace has no access hole, carefully drill an access hole of 1.5 inch (38 mm) or less through the lower sides or bottom of the firebox.

The access hole must be plugged with non-combustible insulation after the gas supply line has been installed. See *Dimensions* section for detailed location of gas inlet. Also, take into consideration whether or not a fan or shut-off valve will interfere when planning routing of the gas line.

Existing Glass Doors and Wire Screens

Existing glass doors must be permanently removed prior to installing the 739IL insert.

Combustible Mantels

Combustible mantel clearances must conform to those required for the original solid-fuel fireplace into which the 739IL is being installed.

Attach Warning Conversion Plate to Existing Fireplace (label supplied loose with 739IL heater)

Attach the “This fireplace has been converted...” label to the existing fireplace using screws or other mechanical means and store any removed parts in back of the existing fireplace for future use.

Appliance Preparation

Unpacking the appliance

Beware of sharp edges! Wear gloves!

1. Unpack the appliance.
2. Unpack any loose items from around the appliance and check against the Pack Content list provided in the documentation package.
3. Remove the window and set aside in a safe place to avoid damage—see next page.
4. **Verify that you have all the components required for the installation, including:**
 - *brick panels & logs;*
 - *surround/doors/fret;*
 - *venting components and accessories;*
 - *blower and electrical components for blower installation if used.*

Window Removal

The window is held in place by four spring-loaded bolts, two at the top and two at the bottom.

1. To remove the window, turn each bolt a quarter turn to disengage the bolt pin.
2. Gently pull the bottom of the window outward and unhook it from the firebox's opening frame.
3. Set the window aside in a safe place to avoid damage.

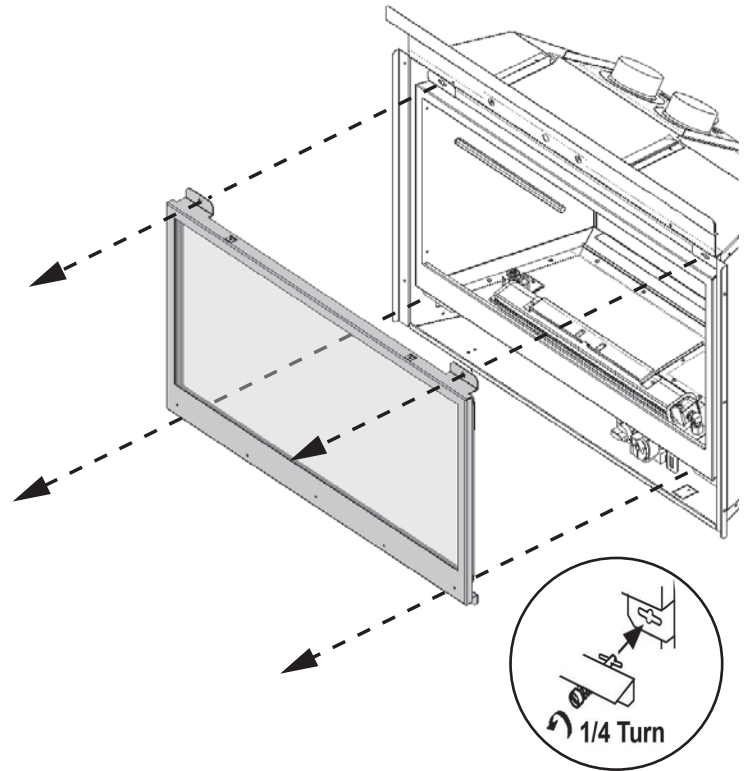

Fan installation

If the 755CFK Circulating Fan Kit (blower) is to be installed, we suggest that you do it now.

The fan cavity is accessible from the back of the firebox to facilitate its installation. If the fan is retrofitted after the installation of the appliance, the burner module will need to be removed. Therefore, we recommend that, where possible, the fan be installed before the appliance is fitted into the cavity.

Refer to instructions provided with the 755CFK to install the fan.

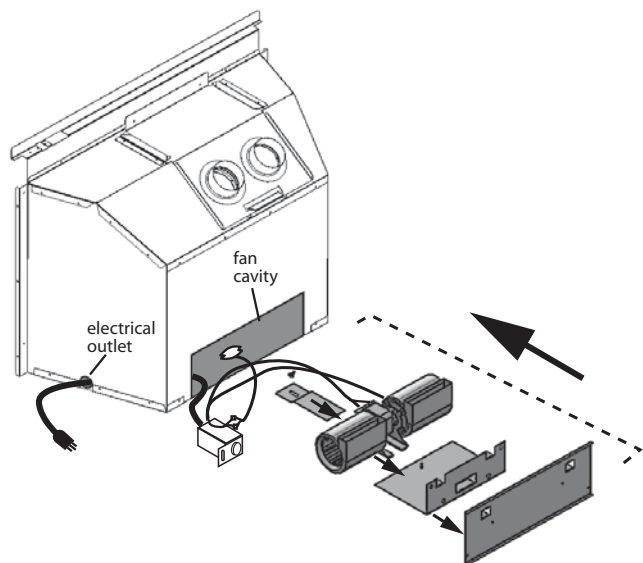

Venting Installation

IMPORTANT: This appliance's venting system is room sealed and therefore, does not require room air to be used in the combustion process.

1. Rough-in two 3" diameter vent liners into the existing chimney system from the roof. Be careful not to tear or damage the liners in the process. It may be easier to install both liners at the same time rather than one at a time. Leave plenty of liners at the bottom to facilitate the connection of the liners to the vent slider. **It is best to leave the top termination until later. Designate and mark the top and bottom of one liner as "EXHAUST" to avoid confusion later.**
2. **a) Large cavity opening**
Slide the appliance into the cavity.
b) Smaller cavity opening
Release the two screws retaining the vent slider to the front of the firebox.
Remove the slider from the firebox by sliding it towards the back of the firebox.
3. Apply RTV sealant to the collars on the vent slider and fit the two liners **ensuring that the exhaust liner is connected to the identified "EXHAUST" vent collar.** Secure with 4 tapping screws per liner.
If the vent slider was removed from the firebox, slide the firebox onto the vent slider in the cavity taking care not to damage the liners. **Make sure that the rear edge of the slider is hooked over the cleat on the firebox.** Secure the vent slider to the front of the firebox with two screws removed earlier.
4. From the roof, pull the liners and fit the flashing.
5. Fit the terminal cap **ensuring that the exhaust liner is connected to the exhaust vent collar.** Secure with 8 screws provided.
6. Seal the terminal and flashing from water penetration as required.

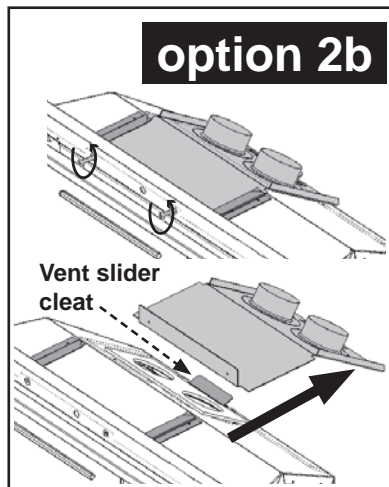
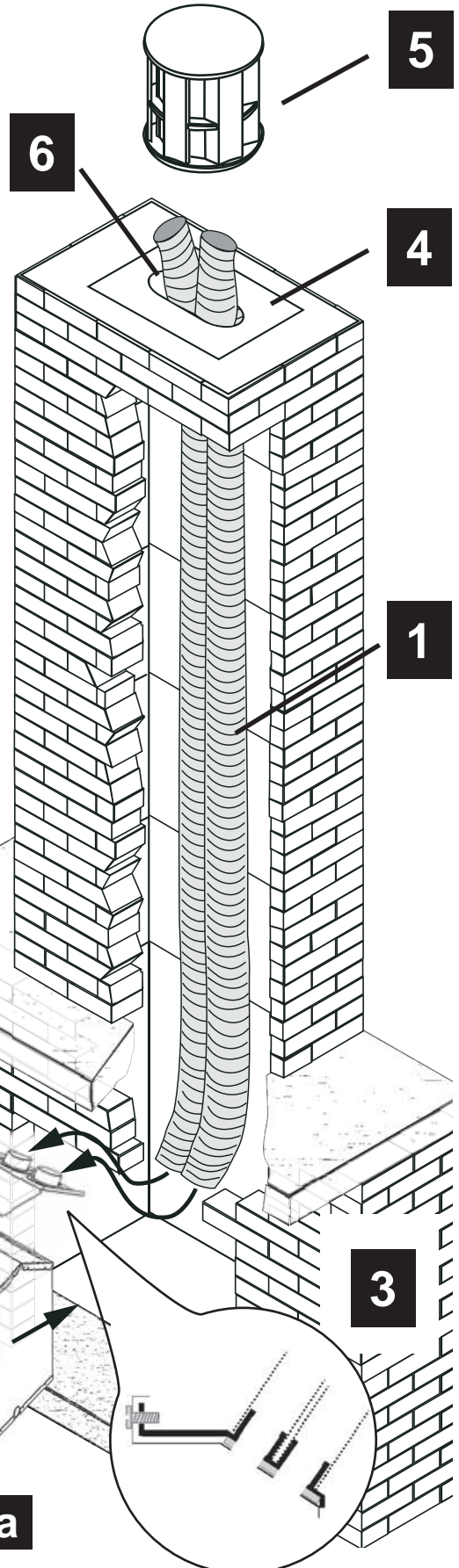

WARNING
Failure to position the parts in accordance with these diagrams or failure to use only parts specifically approved with this appliance may result in property damage or personal injury.

option 2a

The gas supply inlet connection is a 3/8" NPT female connector and is located on the left hand side of the control valve.

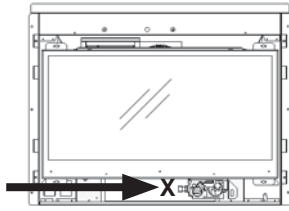

Use only new black iron or steel pipes or copper tubing if acceptable—check local codes. Note that in USA, copper tubing must be internally tinned for protection against sulfur compounds.

The burner platform and gas train on this appliance may be removed as a unit for servicing or to install or remove the optional circulating fan (if installed). Provide some form of pipe union (depending on type of piping) as close as possible to appliance valve.

Unions in gas lines should be of ground joint type.

The gas supply line must be sized and installed to provide a supply of gas sufficient to meet the maximum demand of the appliance without undue loss of pressure.

Sealant used must be resistant to the action of all gas constituents including LP gas. Sealant should be applied lightly to male threads to ensure excess sealant does not enter gas lines.

Pressure test the supply line for leaks.

The appliance and its individual shut-off valve must be disconnected from the gas supply piping system during any pressure testing of that system at test pressures in excess of 1/2 psig (3.5 kPa).

The appliance must be isolated from the gas supply piping system by closing its equipment shut-off valve during any pressure testing of the gas supply piping system at test pressures equal to or less than 1/2 psi (3.5 kPa).

Failure to either disconnect or isolate the appliance during pressure testing may result in regulator or valve damage and void the warranty. Consult your dealer in case of damage.

Pressure Test Points

The minimum supply pressure is given in the section *Specifications* of this manual—page 6.

All piping and connections must be tested for leaks after installation or servicing. All leaks must be corrected immediately.

When testing for leaks:

- Make sure that the appliance is turned off.
- Open the manual shut-off valve.
- Test for leaks by applying a liquid detergent or soap solution to all joints. Bubbles forming indicate a gas leak.

Never use an open flame to check for leaks. Correct any leak detected immediately.

The pressure test tapping locations are shown in the figure below. An internal regulator within the valve controls the burner manifold pressure. The correct pressure range is shown in the table in subsection *Ratings* of this manual on page 6. The pressure check should be made with the burner alight and at its highest setting. See *Lighting Instructions* section for full operating details on page 27.

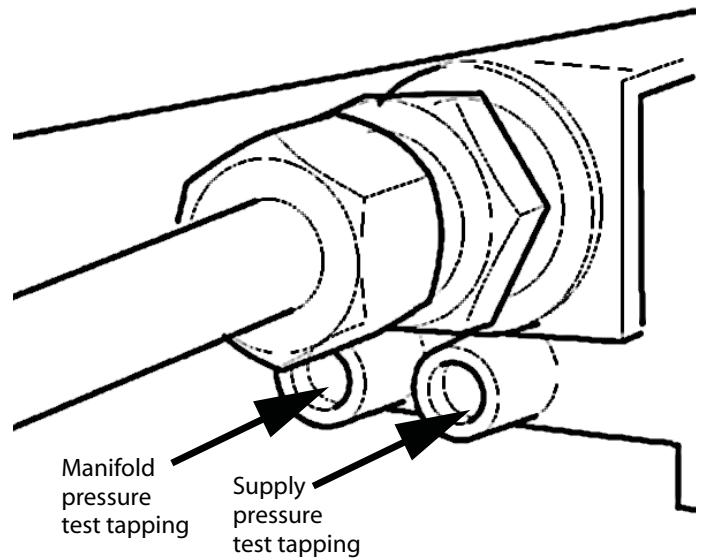

Pressure Testing

Ceramic Bricks Installation

The following guidelines apply for all brick liners.

1. Inside the firebox, on the top of each side, release the screw of the side brick anchors (one per side) just enough to allow them to rotate.

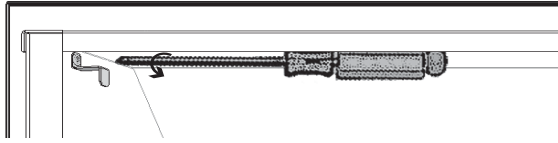

2. Place the rear panel against the back of the firebox, on the ledge at bottom.

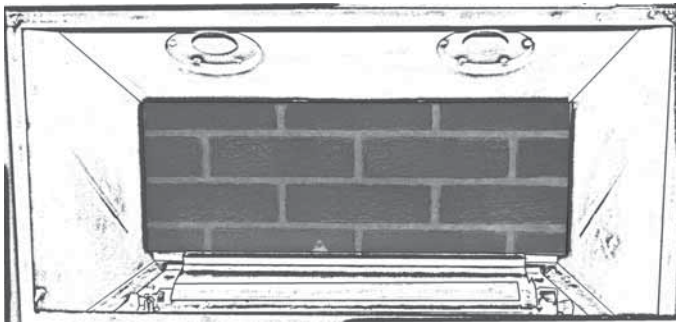

3. Rotate the anchor up and out of the way and slide the left hand side panel against the firebox side. Rotate the anchor back down to hold the panel.

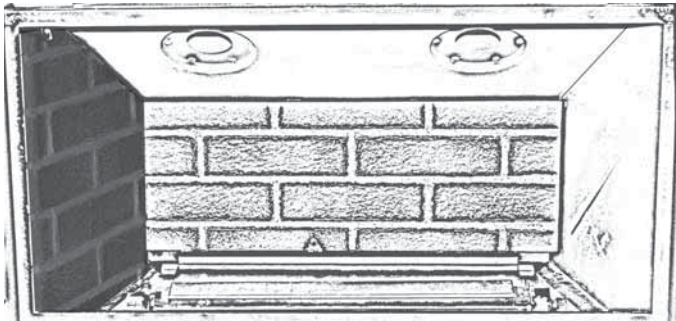

4. Rotate the anchor up and out of the way and slide the right hand side panel against the firebox side. Rotate the anchor back down to hold the panel.

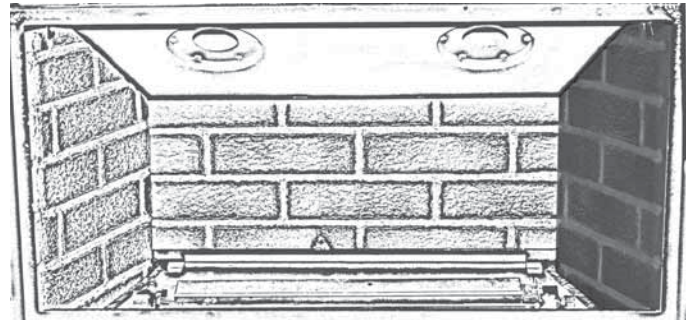

5. Tighten the side brick anchors on each side of the firebox.

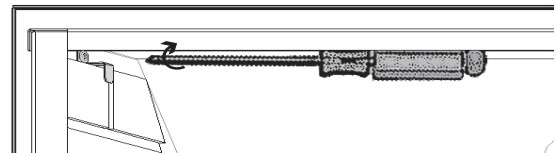

6. Install the port cover fixing it using the two screws already in the firebox top.

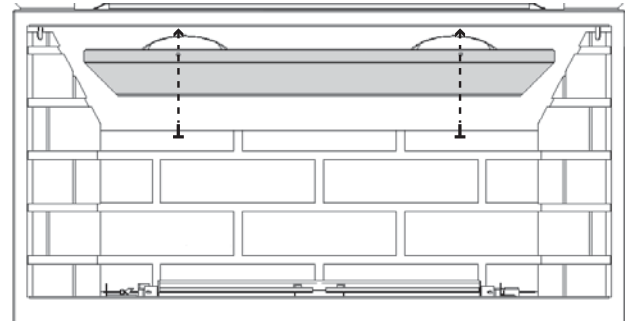

Ceramic Logs Installation

Unpack the ceramic logs very carefully to avoid damaging the fragile material. Install the logs as shown below. Please note that **the position of the Logs is critical to insure proper performance of the appliance.**

1. Spread the decorative charcoals on each side of the log tray, covering the sheet metal as shown.

DO NOT PUT ANY DECORATIVE CHARCOAL PIECES WITHIN THE PILOT SHIELD AREA.

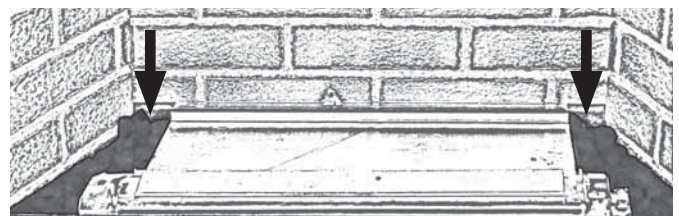
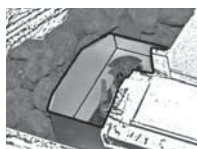

- Place the rear log centering it side to side in the firebox. Position forward until it sits against the sheet metal return behind the burner.

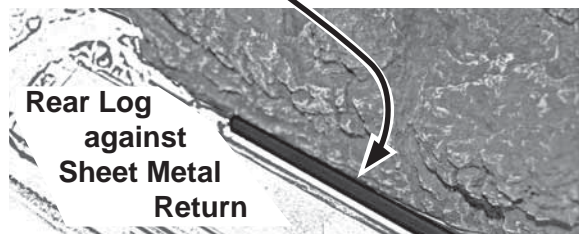
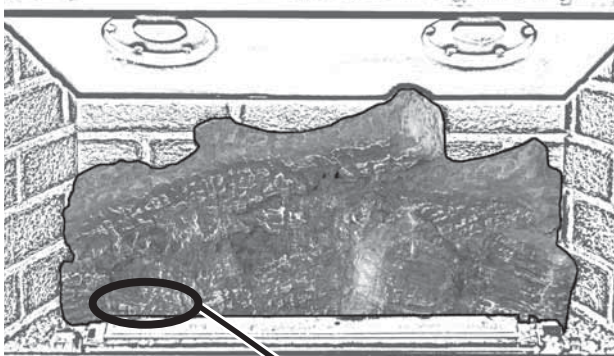

- Place the front left log on top of the burner with its front edge resting slightly on the window frame.
- Place the front right log on the top of the burner with its left end abutted to the front left log and its front edge resting slightly on the window frame. **Center the front logs side to side in relation to the firebox.**

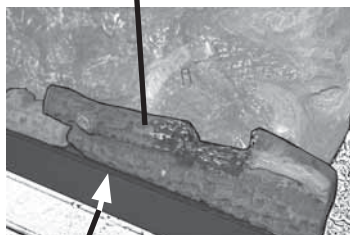
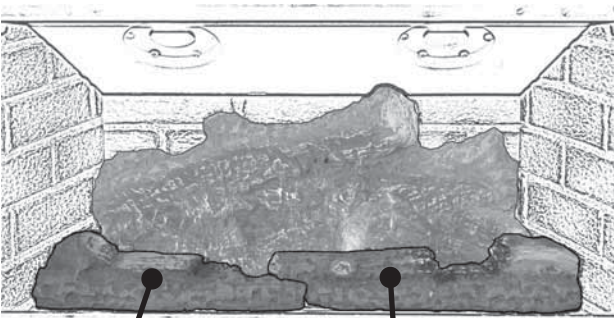

Both front logs to rest slightly on the edge of the firebox window frame.

- Identify the right cross log; it has a hole under on of its end and it is the shortest cross log. Place it on the right pin located on the rear log. Rest its other end in the crook of the front right log.

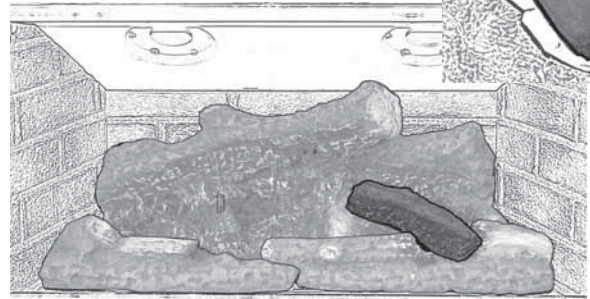

- Identify the middle cross log. It does not have a hole underneath. Place its narrow end on the flat depression in the rear log next to the right cross log. Place its wider end on the front log.

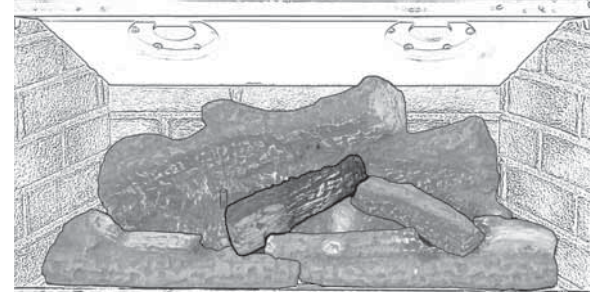

- Identify the left cross log; it has a hole under its narrow end. Place its narrow end on the pin located on the rear log. Rest its wider end on the the crook in the front left log at an angle of approximately 30 degrees from the center line of the fireplace to allow for the flame to come up in front of the rear log.

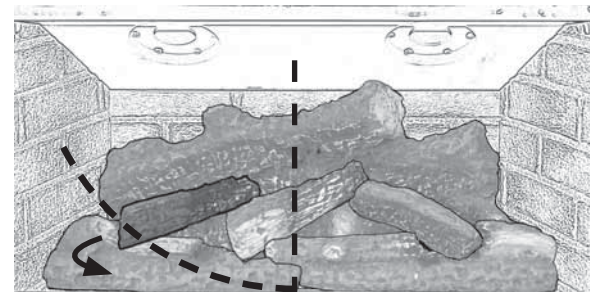

Window Refitting

1. To refit the window, hook its top part to the firebox's opening frame. **Make sure that the wider part of the window frame is at the bottom.**
2. While you hold it, push in and turn the two top spring-loaded bolts a quarter turn to engage their pin.
3. Push in the bottom of the window against the firebox and fasten the two bottom spring-loaded bolts a quarter turn.
4. Then, pull out the top and bottom of the window and release it to insure the springs return it.
5. Apply light hand pressure against the window frame sides to bed-in the window seal.

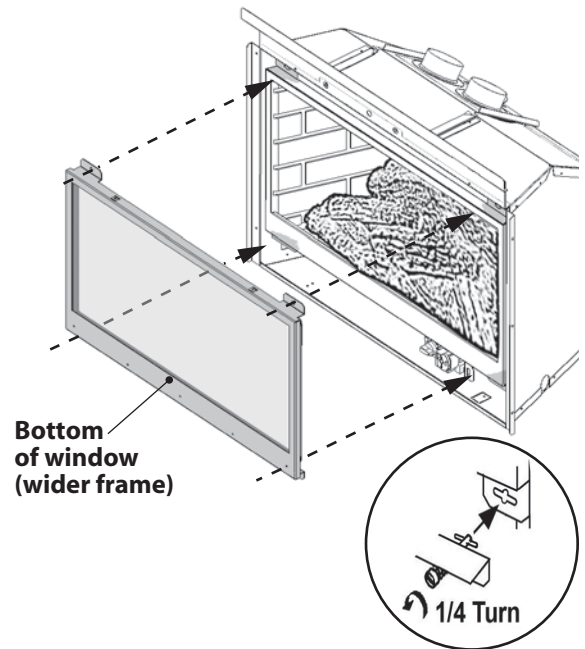

Remote Control Initial Set-up

The receiver and the handset of the remote control system must be initially synchronized before the first use.

1. Insert alkaline batteries in the remote control receiver and handset. The receiver is located left of the control valve under the burner module.
2. With a sharp object, press and hold the receiver's reset button until you hear one short and one long beeps. Release the reset button after the second beep.
3. Within the subsequent 20 seconds, press the small flame button (🔥) on the remote handset until you hear two short beeps confirming the synchronization is set.

This is a one time setting only and is not required when changing the batteries in the remote receiver. The remote control system is now ready to use.

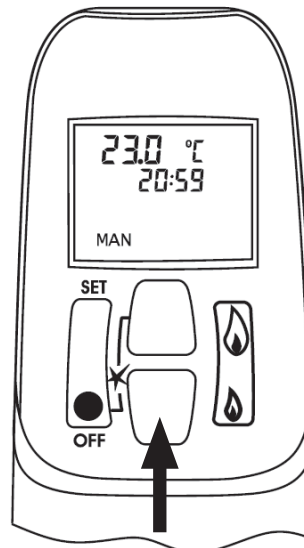
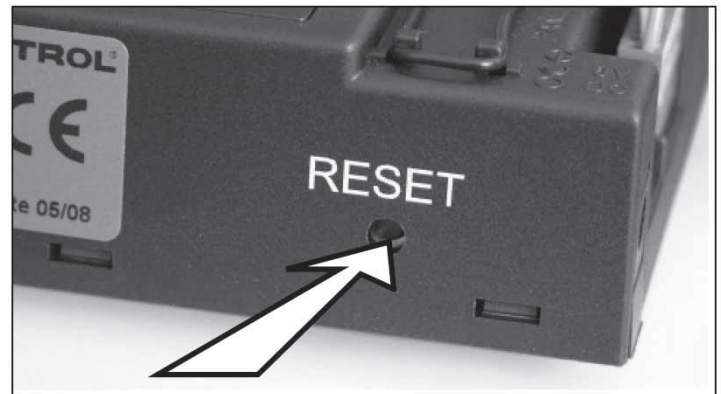

Operation Check

Turn the fireplace flame up and down using the remote control to confirm that the full range of inputs is achieved—see the remote control operation instructions on pages 23–26.

Aeration Settings

Light the fire and allow the unit to warm up for 10–15 minutes to evaluate the flame picture. Burners are equipped with an adjustable shutter to control primary aeration. See the figures below. The shutters are factory-set to an aeration gap which will give optimum performance for the vast majority of installations.

Air Shutters

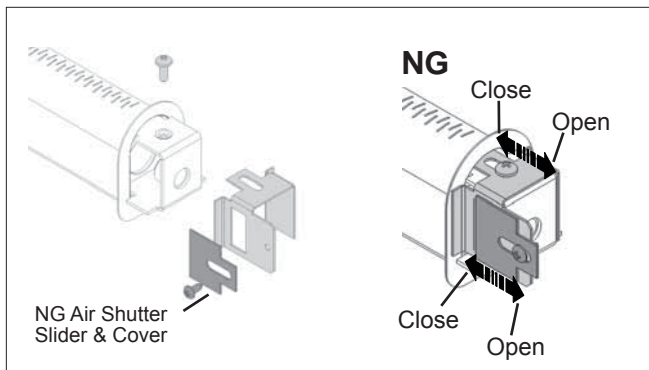

In a few unusual installations, the flame picture may be improved by adjusting the aeration. The need for adjustment should be determined only by operating the appliance with the ceramic logs and window installed.

Increasing aeration (open) will cause the flames to appear more transparent and blue showing more ceramic log glow.

Decreasing aeration (close) will cause the flames to appear more yellow or orange showing less ceramic log glow.

Too little aeration may result in black carbon forming and dropping into the firebox.

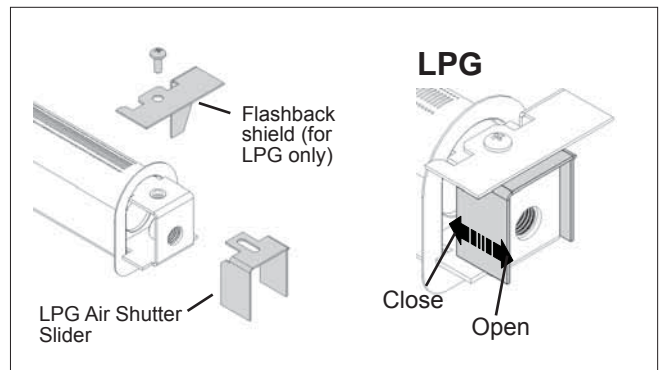

Remote Control Handset Wall Holder Installation

The remote control kit for this fireplace comes complete with a wall-mounted holder. This holder is not required in all installations but is provided as an optional feature for those customers who wish to mount the remote handset to the wall.

To install the holder to the wall, find a convenient location and use the hardware provided with the kit. See the diagram below for required hardware and configurations. Note that the holder can be installed at the base of a light switch plate.

IMPORTANT. The location of the remote control handset is important to assure proper temperature regulation. To obtain a constant temperature, we recommend that the handset should be between 3 and 15 feet away from the appliance **but not directly above it**. We also advise that the handset should be located away from any other heat source and not in direct sunlight as this may affect the temperature sensor located in the remote handset.

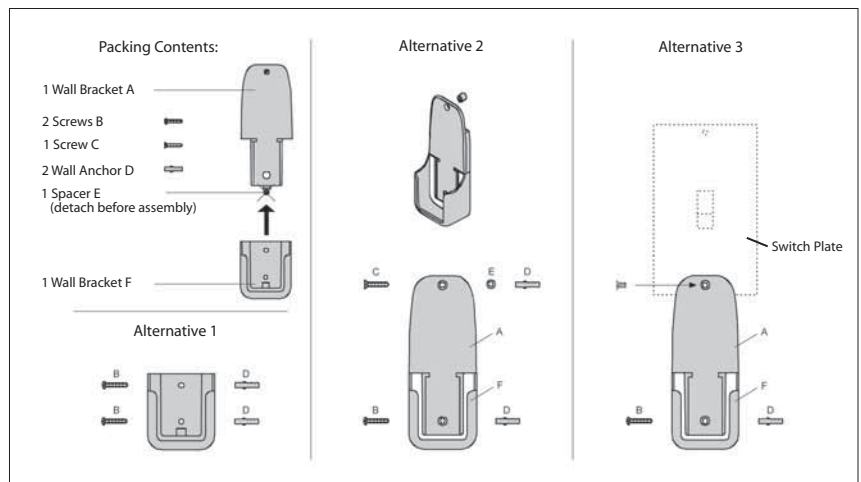

WARNING

EXTREMELY HOT!!!

Some parts of your fireplace are **EXTREMELY HOT**, particularly the window.

DO NOT LET CHILDREN touch the glass or any parts of your fireplace even after it is turned off as it is still hot.

USE A SAFETY SCREEN or a **GATE** to reduce the risk of burns.

Keep the remote control handset **OUT OF REACH** of children.

Avoid placing decorating objects sensitive to heat within 36 inches (0.9 m) around the fireplace.

Performance of LPG appliances may be affected by the quality of commercial gas supplied in your area.

Warranty Card at the back of this manual.



Read the Safety Information on pages 3 and 5 of this manual.

Operating Your Fireplace

For your safety, this appliance is fitted with a flame supervision device which will shut-off the gas supply if, for any reason, the pilot flame goes out. This device incorporates a fixed probe, which senses the heat from the pilot flame. If the probe is cool, the device will prevent any gas flow unless manually lighting the pilot. See full lighting instructions on page 27 of this manual.

Cleaning

WARNING

DO NOT TOUCH THE GLASS WHILE IT IS HOT!
Let the fireplace cool first before cleaning it.

Important - Glass cleaning - Mineral deposits

One of the by-products of the combustion process in a gas appliance is a mineral which can show up as a white film on the ceramic glass of the viewing door.

The composition of the deposit varies with location and time. It is believed to be associated with the varying sulfur content of the gas. You may have the problem intermittently.

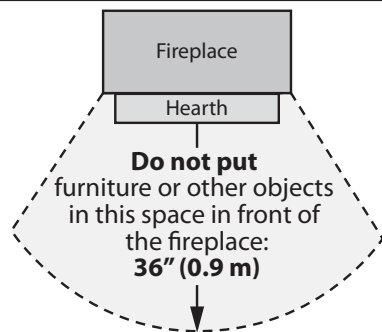

We have consulted with ceramic glass manufacturers and they cannot offer a definitive solution to this problem. Dealers have tried various cleaning products with varying results. The following are recommendations only and are not meant to guarantee results.

NOTE: This is a problem beyond Miles Industries' control and is not covered under warranty.

- Clean the glass regularly as soon as you notice the buildup (white film). If the film is left for a longer period of time, it will etch into the glass. It is then much harder, if not impossible, to remove.
- **NEVER use an abrasive cleaner on the ceramic glass.** Any abrasion of the surface has the immediate effect of compromising the strength of the glass. An emulsion type cleaner is recommended.
- Use a soft damp cloth to apply the cleaner. Dry the glass with a soft, dry, preferably cotton cloth. Most paper towels and synthetic materials are abrasive to ceramic glass and should be avoided.
- Our dealers have had good results from the products listed below. We cannot, however, guarantee the results of these products.

» BRASSO, POLISH PLUS by KELKEM, COOK TOP CLEAN CREME by ELCO, WHITE OFF by RUTLAND, TURTLE WAX

Do not clean the glass while it is hot. Always securely replace the window before lighting. **If broken, the glass pane may only be replaced as a complete window unit as supplied by the manufacturer.**

To remove the window for cleaning:

1. To remove the window, turn each bolt a quarter turn to disengage the bolt pin.
2. Gently pull the bottom of the window outward and unhook it from the firebox's opening frame.
3. Set the window aside in a safe place to avoid damage.

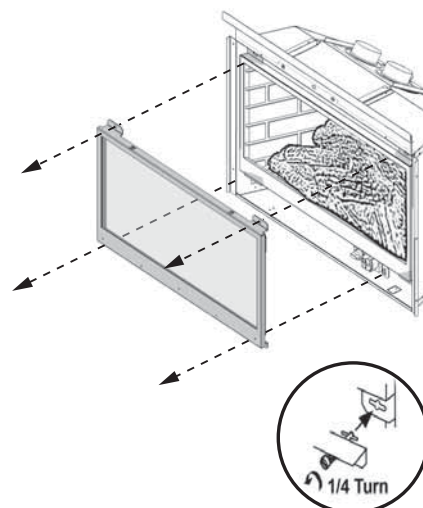

To refit the window:

1. To refit the window, hook its top part to the firebox's opening frame. **Make sure that the wider part of the window frame is at the bottom.**
2. While you hold it, push in and turn the two top spring-loaded bolts a quarter turn to engage their pin.
3. Push in the bottom of the window against the firebox and fasten the two bottom spring-loaded bolts a quarter turn.
4. Then, pull out the top and bottom of the window and release it to insure the springs return it.
5. Apply light hand pressure against the window frame sides to bed-in the window seal.

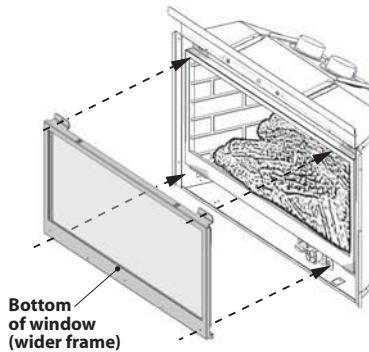

Soot or dust can be brushed from the ceramic logs and firebox walls using a soft brush. Dust can also be removed from the burner using a soft brush after removing the ceramic logs. When cleaning, make sure that no particles are brushed into the slots of the burner.

Checks

A periodic check of the pilot and burner flames should be made. Check after the fire has been on for at least 30 minutes. The pilot flame must cover the tip of the thermocouple probe. The main burner flame pattern will vary from appliance to appliance depending on the type of installation and climatic conditions.



Correct Flame Picture

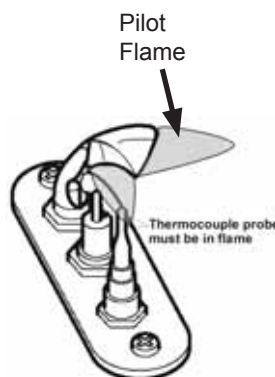

Pilot Flame can be seen between logs

The appliance area must always be kept clear and free from combustible materials, gasoline and other flammable vapors and liquids.

Inspect the vent terminal outdoors regularly to make sure that snow, trees, bushes, leaves, or other objects do not obstruct it.

Examine the vent system and terminal regularly. We recommend annually.

Batteries

WARNING

DO NOT ATTEMPT TO CHANGE THE BATTERIES WHILE THE FIREPLACE IS STILL HOT! Let the fireplace cool first before touching it.

CAUTION

DO NOT USE a screwdriver or other metallic object to remove the batteries from the receiver or the handset! This could cause a short circuit to the receiver.

Low battery signal: see page 26.

BEFORE changing the batteries, turn off the valve using the manual On/Off switch—see instructions next page.

The appliance uses four 1.5 V AA alkaline batteries for its remote control receiver and one 9 V alkaline battery for its handset. Batteries should last one to two seasons, depending on usage. Removing the batteries in the off-season will extend the battery life. Should the batteries loose power, the control may be operated by manually turning the control knob at the valve or by turning off the valve at the switch.

To replace the batteries in the remote control receiver:

1. The receiver is located to the left of the valve and it is retained to the firebox by a *Velcro* tab. Grab the receiver and pull it out from its location.
2. Slide and remove the receiver cover.
3. Replace the 4 AA batteries.
4. Replace the cover.
5. Put the receiver back in its position pushing it in so it attaches to the *Velcro* tab.

Lighting, Operation and Rating Information

WARNING

DO NOT ATTEMPT TO TOUCH THE DATA PLATE WHILE THE FIREPLACE IS STILL HOT! Let the fireplace cool first before touching it.

The Lighting, Operation and Rating information is located on a plate under the burner. To access the plate, remove the fret or access panel, grab the plate and take it out to read it. There is important information on both sides of the plate.

Servicing

If any attention is required for your appliance, contact your supplier quoting the model number. It will be helpful if the appliance's serial number can also be quoted. This number is on the rating plate, which is located under the burner. The replacement parts are shown at the end of this manual. Please always quote the part number and description when requesting spare parts.

Fireplace Control Devices

There are three ways to control your fireplace.

1. Thermostatic Remote Control;
2. Wall Switch (optional);
3. Manual On/Off Switch.

The manual On/Off switch must be ON for the fireplace to function. It can be used to shut off the fireplace in case of emergency—see next sub-section.

The Thermostatic Remote Control can be programmed to function automatically—see pages 23–26.

The Wall Switch (optional) can be used to turn on, off and to increase or decrease the flame height—see 1265WSK—Wall Switch Kit.

NOTE: The remote control in the AUTO mode will override the wall switch.



Thermostatic Remote Control



Wall Switch (optional)

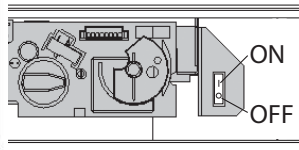

Manual On/Off Switch

How to Turn Your Fireplace OFF (including pilot)

Familiarize yourself with each of these methods before operating your fireplace.

Handset and Wall Switch: Press and hold the OFF button for a second.

If the flames are on, they go down and you hear the valve motor wind down. You hear a clunk and a beep indicating that the valve has received the signal from the remote control.

Manual ON/OFF Switch: Press the **O** button.

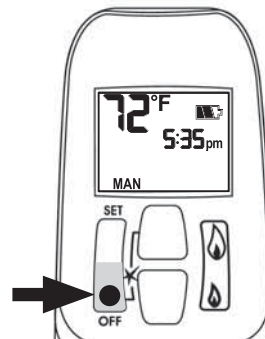

Remote control handset

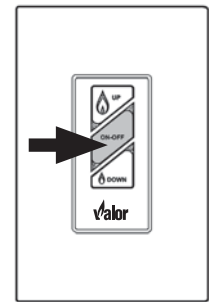

Wall Switch (optional)

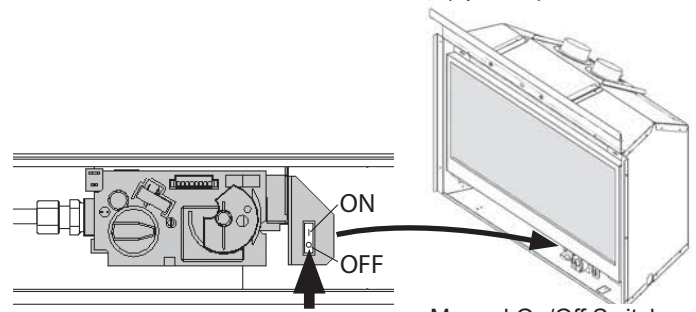

Manual On/Off Switch

How to Ensure Your Fireplace Cannot Be Turned ON Inadvertently

You can use one of the two following methods to ensure that your fireplace will not turn on when you don't want it on.

First, ensure your fireplace is turned off—including the pilot—and cold BEFORE going ahead.

Remove all batteries from the receiver as well as the battery from the handset.

Alternately, you can prevent your fireplace from lighting by pressing the **O** button on the manual ON/OFF switch on the gas valve—see image above.

Automatic Shut-Off (in certain conditions)

Your fireplace's remote control is equipped with an automatic shut-off mechanism which is activated in certain conditions. See page 26 in the *Remote Control Operation* section for a description of this feature.

NOTE: Before using the remote control system for the first time, the receiver and the handset must be synchronized. See the section *Remote Control Initial Set-up* on page 18 in this manual.

Your fireplace remote control helps you get the comfort, convenience and aesthetics you want from your gas fireplace. The remote controls your fireplace in different ways.

IMPORTANT: BEFORE YOU BEGIN, please note that on this system, the settings of time, temperature and automatic ON/OFF can only be programmed when the function display is flashing. Be patient when programming as it can take a few seconds to set.

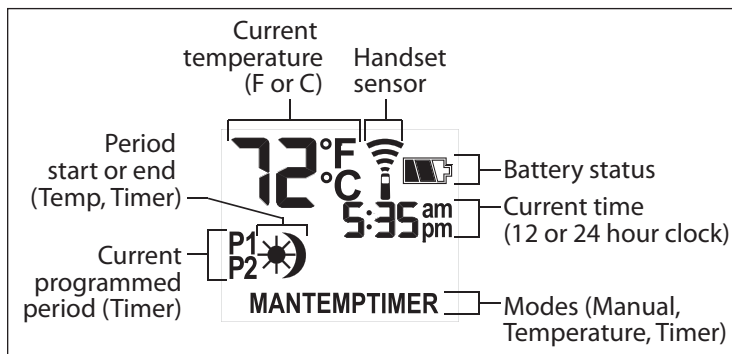

Display Overview

Note: In the TEMP or TIMER modes, the remote handset senses the room temperature and adjusts the flame accordingly.

To communicate, the handset should be within 15 feet (4.5 meters) of the fireplace.

Do not leave the handset on the mantel or hearth.

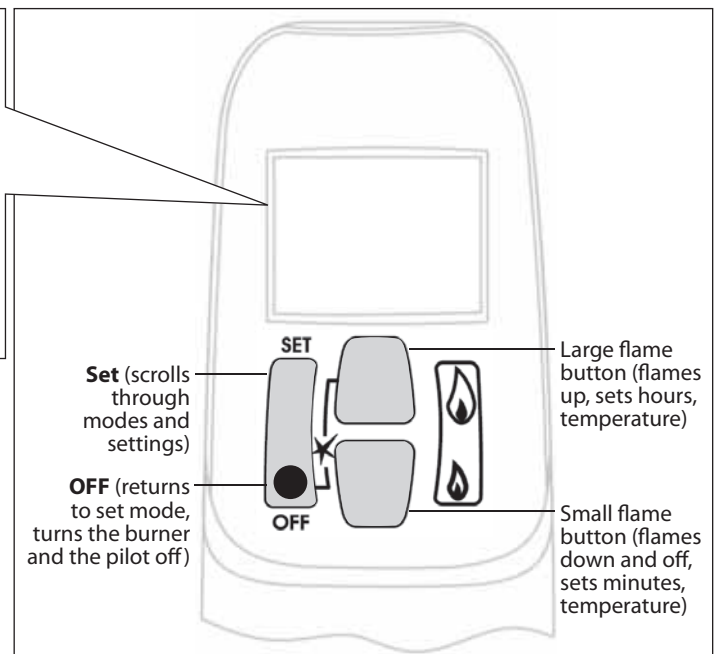

Handset Overview

Turning your fireplace ON

WARNING: When the pilot is lit, the valve motor turns automatically to maximum flame height.

1. Make sure that the MAN knob on the valve is in ON position.
2. Make sure that the switch on the valve is in the I position.
3. Press and hold the OFF and  (large flame) buttons until you hear a short acoustic signal. Release the buttons.

The acoustic signals will continue until the pilot lights. The remote control will go automatically into TEMP mode. The flame will be at maximum height until the remote control reads the temperature (factory set) and will then adjust the flame accordingly.

You can put the remote in MAN manual mode, change the temperature in TEMP mode or program your remote in TIMER mode as indicated in the following sections.

Turning your fireplace OFF

1. Press the  (small flame) button to reduce the flame to pilot.
2. Press the OFF button to turn the pilot off.

Alternately, you can press the  button on the switch if you won't use your fireplace for a long period of time, if you cannot locate your remote control handset or if you wish to change the batteries.

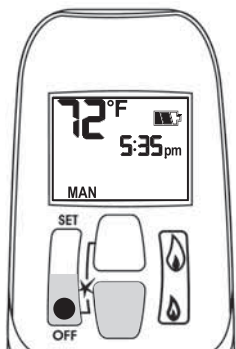
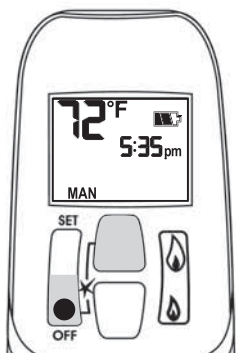

Operation Modes

MAN MAN MODE—Manual Mode. You can use this mode to adjust the flame height up or down.

☀️ TEMP TEMP MODE—Daytime Temperature Mode (appliance must have pilot ignited): The room temperature is measured and compared to the set temperature. The flame height is then automatically adjusted to achieve the Daytime set temperature.

🌙 TEMP TEMP MODE—Nighttime Setback Temperature Mode (appliance must have pilot ignited): The room temperature is measured and compared to the Nighttime Setback temperature. The flame height is then automatically adjusted to achieve the Nighttime Setback temperature.

TIMER TIMER MODE—(appliance must have pilot ignited): The Timer setting allows you to set two burner ON times and two burner OFF times for every 24-hour period.

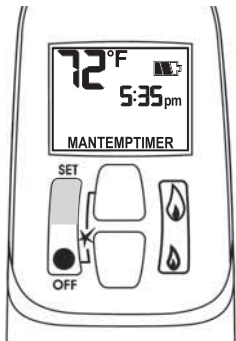

Scrolling through modes and functions

Briefly pressing the **SET** button changes the operation sequences in the following order:

MAN → ☀️ TEMP → 🌙 TEMP → TIMER → and back to MAN.

NOTE: MAN mode can also be reached by pressing either the 🔥 or 🔥 buttons.

| Mode | Sun ☀️ | Moon 🌙 |
|--------------|-----------------------------|-------------------------------|
| TEMP | Daytime temperature setting | Nighttime temperature setting |
| TIMER | Start time setting | Stop time setting |

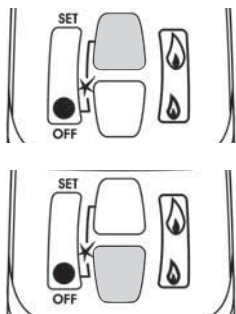

Flame Height

The flame height can be adjusted in the following manners. In MANUAL mode,

1. Press the 🔥 (large flame) button to turn on the main burner.
2. Press the 🔥 (large flame) button to increase the flame height.
3. Press the 🔥 (small flame) button to decrease the flame height or to go to pilot position.

For fine adjustments, tap the 🔥 and 🔥 buttons.

NOTE: While pressing either button, a symbol indicating transmission appears on the upper right hand corner of the display. The receiver confirms transmission with an acoustic signal.

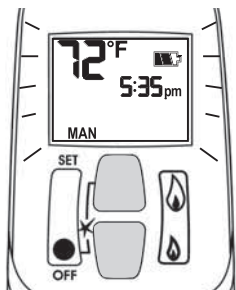

Time

To set the time, follow the steps below.

1. The display indicates °C/24-hour or °F/12-hour clock. To change from one to the other, press and hold both the **OFF** and 🔥 buttons until the display changes.
2. To set the time, hold down **both** the 🔥 and 🔥 buttons until the display flashes. Let go.
3. Quickly press the 🔥 button to set the hour and the 🔥 button to set the minutes.
Note: You must start setting the time while the display is flashing. If it stops flashing, go back to 2.
4. Press the **OFF** button to return to manual mode or simply wait and it will automatically return to Manual mode.

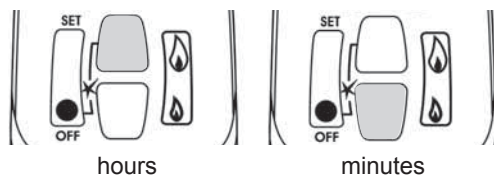

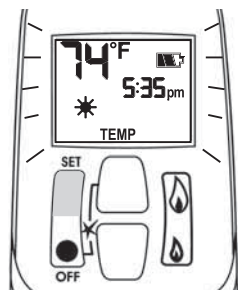

Temperature

Use this setting when you come in and want to enjoy a set temperature.

1. Select either the ☀ **TEMP MODE** or the 🌙 **TEMP MODE** by briefly pressing the **SET** button.
2. Hold the **SET** button until the **TEMP** display flashes.
3. Set the desired temperature with the 🔥 or the 🔥 buttons.
Note: 4.5°C/40°F is the minimum temperature setting.
4. Press the **OFF** button or simply wait and the display will go to the temperature control mode.
Note: If you would like the Nighttime Setback temperature control to turn off, decrease the 🌙 **TEMP MODE** setting until [---] appears on the display.
Your fireplace will reach the set temperatures and the remote handset will check the temperature every five minutes, adjusting the amount of fuel needed to give you a steady, even heat.
5. The display must remain in **TEMP** mode on the remote handset.

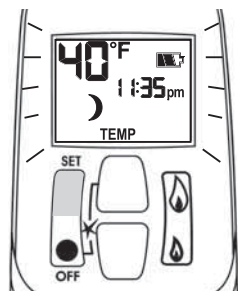

Timer

It is possible to program two periods of time per day at which your fireplace will turn on and off automatically.

For example, you can set your fireplace to turn on in the morning just before you get up (P1 ☀ [start time]) and to turn off when you leave for the day (P1 🌙 [stop time]). Then, you can set your fireplace to turn on again at the end of the day (P2 ☀ [start time]) and to turn off when you go to bed at night (P2 🌙 [stop time]).

If you wish to set only one time period at which your fireplace will turn on and off, program P2 ☀ [start time] and P2 🌙 [stop time] for the same time as P1 🌙 [stop time].

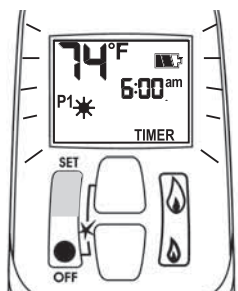

1. Select **TIMER** mode by briefly pressing the **SET** button.
2. Press and hold the **SET** button until **TIMER** is displayed on the lower right hand side.
3. Press and hold the **SET** button until P1 ☀ and the time display flashes. Set the start time by pressing the 🔥 button for the hour and the 🔥 button for the minutes. Then, briefly press **SET** to P1 🌙 and set the stop time in the same manner you just set P1 ☀.
4. Briefly press the **SET** button again for the next burner cycle time, which will be P2 ☀ and P2 🌙.
5. Once all four times are set, press **OFF** or simply wait to complete programming.
6. The remote handset must remain in **TIMER** mode to function automatically.

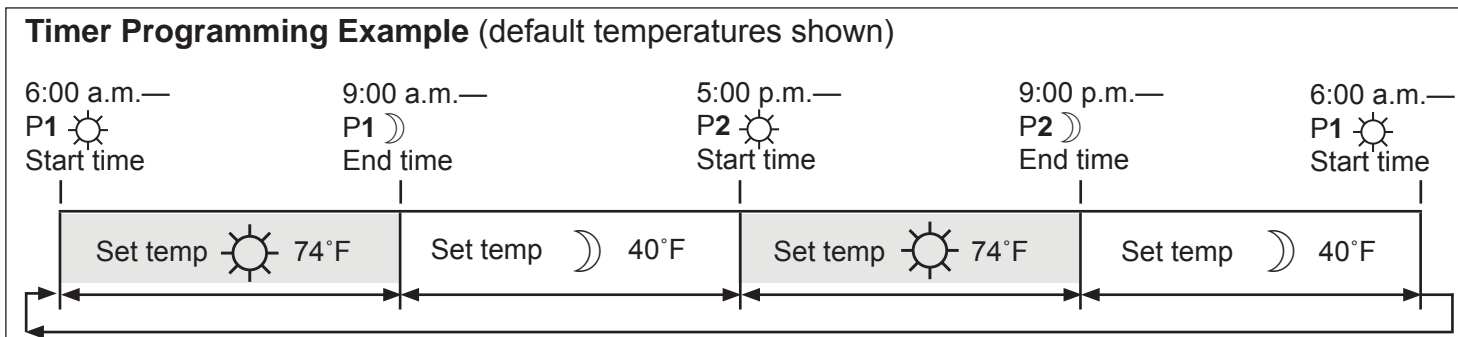
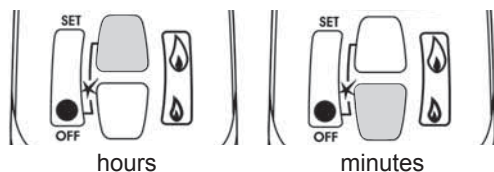
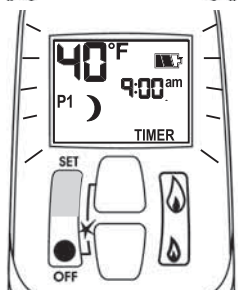

Low Battery Indication

Remote handset: BATT will appear on the display when the battery needs to be replaced.

Replace with one 9 V **alkaline** battery.

Receiver: Three short 'beeps' will sound when the motor turns when the batteries need to be replaced. Replace with four 1.5 V **alkaline** batteries.

NOTE: With very low battery, the valve shuts off the fire completely. This does not happen when the power supply is interrupted.

Handset / Receiver Match

The remote control handset and receiver are programmed to function together. In case of a replacement of the handset or the receiver, you will need to reset the receiver to allow them to function together. Contact your dealer for details

Automatic Turn Down

- **No communication.** If there is no transmission from the handset to the receiver within a 6-hour period, the appliance will go to pilot.
- **No change in flame height.** If there is no change in the flame height for a 6-hour period, the appliance will go to pilot. Note: In **TEMP** or **TIMER** modes, the flame height will change according to the temperature in the room. The appliance will continue to function normally.

Automatic Shut-Off

- **Low batteries in the receiver.** If the power of the batteries for the receiver is low, the appliance will shut off completely, including the pilot.
- **No change in pilot.** If the appliance is left continuously on pilot mode for 5 days, it will shut off completely.

CAUTION

DO NOT USE a screwdriver or other metallic object to remove the batteries from the battery box or the handset! This could cause a short circuit.

Options**Venting (required)**

See approved venting accessories listed below.

Inner Front (required)

See your dealer for your choice of Inner Fronts.

Outer Surrounds, Trims & Frets (optional)

See your dealer for your choice of Outer Surrounds and Trims and Frets.

Optional Accessories

755CFK—Fan Kit

1265WSK—Wall Switch Control Kit

759EBL—Enamel Liner

754RSK—Rock Set Kit

760CBL—Ceramic Black Liners (fluted)

Conversion Kit (optional)

739PGK—Conversion Kit to Propane Gas

739NGK—Conversion Kit to Natural Gas

Hearth Gate (optional)

Hearth gates such as Cardinal's VersaGates are available at retail stores carrying safety products for children.

FOR YOUR SAFETY, READ BEFORE LIGHTING

WARNING: If you do not follow these instructions exactly, a fire or explosion may result causing property damage, personal injury or loss of life.

- A. This appliance has a pilot which must be lighted by hand or by remote control. Follow these instructions exactly. To save gas, turn the pilot off when not using the appliance for a prolonged period of time.
- B. **BEFORE LIGHTING**, smell all around the appliance area for gas. Be sure to smell next to the floor because some gas are heavier than air and will settle on the floor.
- WHAT TO DO IF YOU SMELL GAS
- Do not try to light any appliance.
 - Do not touch any electric switch; do not use any phone in your building.
 - Immediately call your gas supplier from a neighbor's phone. Follow the gas supplier's instructions.
 - If you cannot reach your gas supplier, call the fire department.
- C. Use only your hand to push in or turn the control knobs. Never use tools. If the knobs will not push in or turn by hand, don't try to repair them; call a qualified service technician. Force or attempted repair may result in a fire or explosion.
- D. Do not use this appliance if any part has been under water. Immediately call a qualified service technician to inspect the appliance and to replace any part of the control system and any gas control, which has been under water.

LIGHTING INSTRUCTIONS

1. STOP! Read the safety information above. Dependent on model, switch #1 may be mounted directly to valve see Fig 2A.

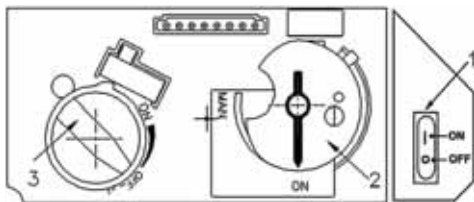

Fig 1

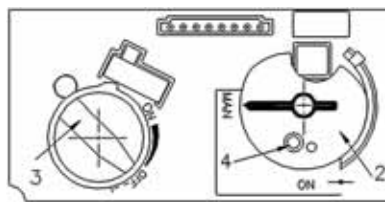

Fig 2

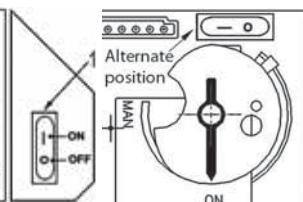



Fig 2A

2. SET ON/OFF SWITCH (1) TO "OFF" POSITION.

- Wait five (5) minutes to clear out any gas, then smell for gas, including near the floor. If you smell gas, STOP! Follow "B" in the safety information above on this label. If you don't smell gas, go to the next step.

3. AUTOMATIC IGNITION (fig. 1): Locate the pilot (fig 3.) inside of firebox at Left Hand side.

- ON/OFF switch (1) in ON position, MAN-knob (2) in ON position; set Flame Adjustment knob (3) to lowest setting (U);
- On the remote control handset, press and hold the 'off' button and  (large flame) simultaneously; a short acoustic signal confirms the start has begun;
- Further short acoustic signals indicate the ignition process is in progress;
- When the pilot is lit, the Flame Adjustment knob (3) will automatically rotate to the highest setting.
- Press the  (small flame) on the remote control handset to reduce the flame height.

4. MANUAL IGNITION (fig. 2): With the window off, locate the pilot (fig. 3) inside of firebox at Left Hand side;

- ON/OFF switch (1) in ON position, MAN-knob (2) in MAN position;
- Set Flame Adjustment knob (3) to the lowest setting (U);
- Push down the metallic core (4) with a pen or similar instrument; this will establish the pilot gas flow;
- Light gas at the pilot (5) with a match;
- Continue holding down metal core (4) for about 10 seconds; after release, pilot should remain lit;
- If the pilot will not stay lit after several tries, turn the gas control knob (3) to "OFF" (U) and call your local service technician or gas supplier.

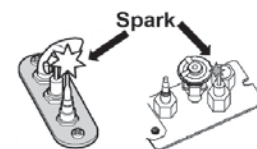



Fig 3

Reinstall the window and set the MAN-knob (2) to "ON"; turn Flame Adjustment knob (3) up (U) or down manually or use the up/down 'flame' buttons on the remote control handset to adjust the flame height.

TO TURN OFF GAS TO APPLIANCE

1. AUTOMATIC SHUT-OFF (using the remote control handset):

- Press and hold the  (small flame) on the remote control handset to shut-off the main burner gas flow;
- Press "OFF" button on remote handset to shut-off the appliance, including pilot flame.



2. MANUAL SHUT-OFF (using only the ON/OFF switch (1))

- Press "O" the ON/OFF switch (1) to shut-off the appliance.

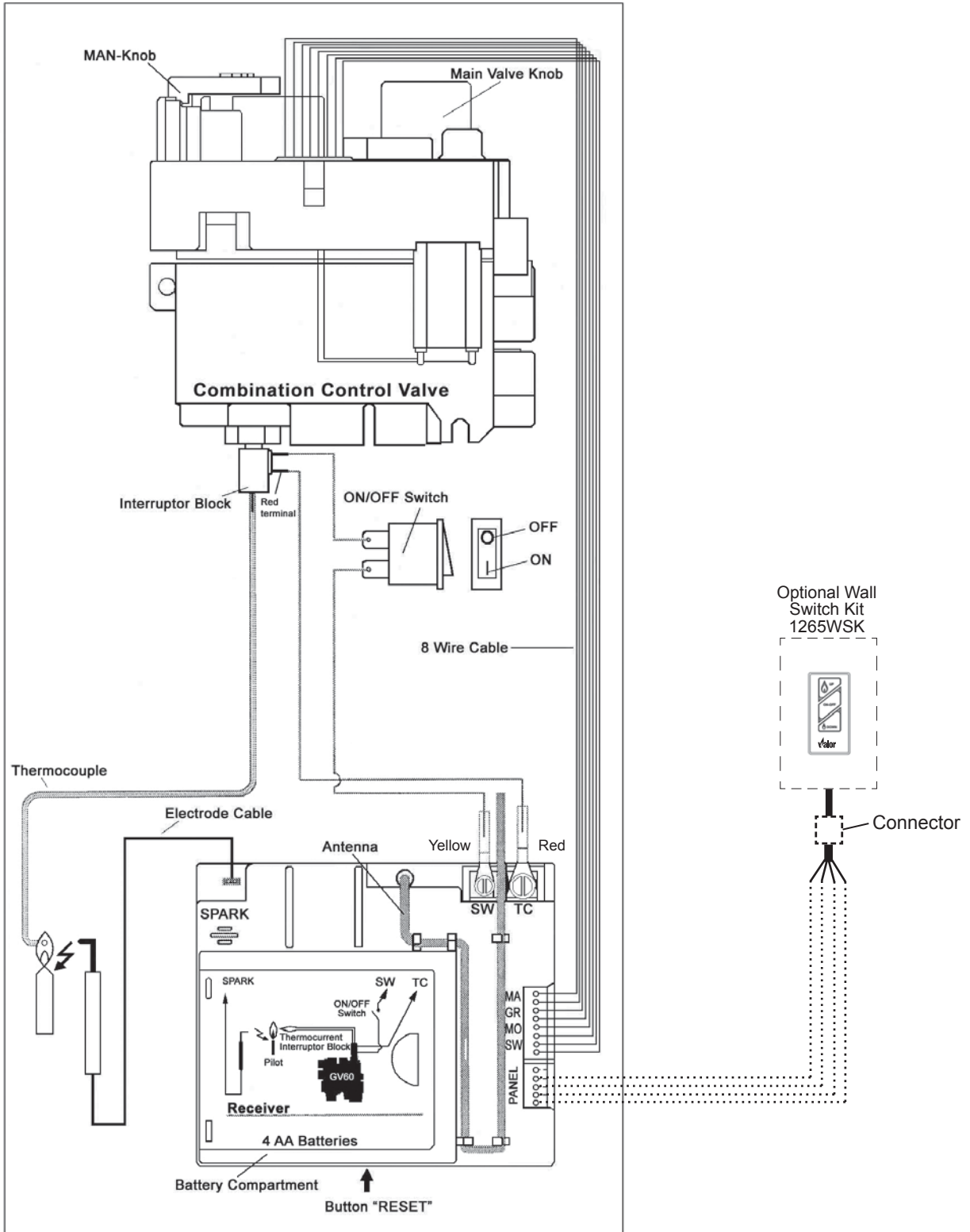
Wiring Diagram



GV60 Wiring Diagram

| APPROVED DIRECT VENT SUPPLIERS FOR VALOR MODELS 739 & RF24DV | | | | | | | | |
|--|--------------------------------------|---|-----------|--|----------------|-------------------|----------------------------|--------|
|   Venting Parts Description | | Venting Parts Code / availability by Manufacturer | | | | | | |
| | | SIMPSON DURA-VENT | SELKIRK | ICC EXCEL DIRECT | SECURE VENT | RLH INDUSTRIES | MILES INDUSTRIES | |
| Termination Caps | Vertical | Standard Co-axial | 46DVA-VC | 4DT-VC | TM-4VT | — | HSDV4658-1313 | — |
| | | High Wind Co-axial | 46DVA-VCH | — | — | SV4CGV | — | — |
| | | Extended Co-axial | 46DVA-VCE | — | — | — | — | — |
| | | Co-linear | — | — | — | 3PDVCV | HS-C33U-99 HS-C33F-1313 | 559CLT |
| Vent Adapters / Couplers | Universal Adapter 3” Flex Coupler | 2150 | — | TM-CFAA3 | — | — | — | |
| | Co-linear Flex Connector | 46DVA-ADF | — | — | — | — | — | |
| | Co-axial-to-Co-linear Adapter | 46DVA-GCL | — | TM-4CAA | — | — | 556CLA | |
| | Co-linear-to-Co-axial Adapter | 46DVA-GK | — | TM-4CTA | — | — | — | |
| Aluminum Flexible Liner | 3” diameter | 2280 Series | 3” ACFL | NOTE: 2-ply liner approved to CAN/ULC S635 suitable for venting gas appliances. As manufactured by Z-Flex. | | | | |
| Flashings | Roof Flashing 0/12-6/12 | 46DVA-F6 | 4DT-AF6 | TF-4FA | SV4FA | — | — | |
| | Roof Flashing 7/12-12/12 | 46DVA-F12 | 4DT-AF12 | TF-4FB | SV4B | — | — | |
| | Flat Roof Flashing | 46DVA-FF | — | TF-4F | SV4F | — | 559FSK | |
| | Masonry Flashing | — | — | TF-4MF | — | — | — | |

Notes: 1) Follow instructions supplied with each manufacturer’s components. 2) Termination caps manufactured by RLH Industries are from Homestyle Chimney Collection and can be ordered in one of the following finishes: a) aluminum; b) black powder coated; c) solid copper.

If you have a problem with this unit, please contact your dealer or supplier immediately. Under no circumstances should you attempt to service the unit in any way by yourself. The warranties in paragraphs 1 and 2 are provided only to the first purchaser/user of this unit, are not transferable and are subject to the conditions and limitations in paragraphs 3, 4 and 5. Please review the conditions and limitations carefully and strictly follow their requirements.



1. Extended Warranty Coverage

For a period of up to ten (10) years, Miles Industries Ltd., (the "Company") or its appointed distributor will at its option pay the initial purchaser for the repair of, or will exchange the following parts or components which are found to be defective in material or workmanship under normal conditions of use and service:

| Part or Component | Defect Covered | Maximum Warranty Period |
|----------------------------|--|-------------------------|
| Exterior steel casing | Corrosion | 10 years |
| Glass | Loss of structural integrity | 10 years |
| Cast iron parts | Corrosion | 10 years |
| Firebox and heat exchanger | Corrosion (but not discoloration) causing loss of structural integrity | 10 years |

2. Two-Year Parts Warranty

In addition, for two (2) years from the date of purchase, the Company, at its option, can repair or exchange all parts and components not listed above but that are found to have a *bona fide* defect in material or workmanship under normal conditions of use.

3. Conditions and Limitations

- a) The warranty registration card must be completed by the initial owner and returned to the Company within 90 days of purchase.
- b) Installation and maintenance must be performed by an authorized and trained dealer in accordance with the Company's installation instructions.
- c) This warranty is void where installation of the unit does not conform to all applicable codes including national and local gas appliance installation codes and building and fire codes.
- d) The owner must comply with all operating instructions.
- e) The Company is not responsible for the labor costs to remove defective parts or re-install repaired or replacement parts.
- f) The first purchaser or user of the unit will be responsible for any shipping charges for replacement parts as well as travel time incurred by the dealer to perform the warranty work.
- g) This warranty applies to non-commercial use and service and is void if it is apparent that there is abuse, misuse, alteration, improper installation, accident or lack of maintenance to the unit.
- h) This warranty does not cover damage to the unit through:
 - i) Improper installation, operational or environmental conditions.
 - ii) Inadequate ventilation in the area or competition for air from other household equipment or appliances.
 - iii) Damage due to chemicals, dampness, condensation, or sulphur in the fuel supply lines which exceeds industry standards.
- i) This warranty does not cover glass, log breakage or damage to the unit while in transit.
- j) The Company does not allow anyone to extend, alter or modify this warranty and assumes no responsibility for direct, indirect or consequential damages caused by the unit. State or provincial laws where the first purchaser or user resides may provide specific rights to extend this warranty and, if so, the Company's sole obligation under this warranty is to provide labor and/or materials in accordance with those laws.

4. Discharge of Liability

After two (2) years from the date of purchase, the Company may, at its option, fully discharge all obligations under this warranty by paying to the first purchaser/user the wholesale price of any defective parts.

5. No Other Warranty

All obligations to repair this unit are defined in this warranty. Some states or provinces may specifically mandate additional warranties on the part of manufacturers, but in the absence of such specific legislation, there is no other warranty or obligation expressed or implied.

Spare Parts

| Code | Description | Part Number | Code | Description | Part Number |
|------|--|-------------|------|-------------------------------------|-------------|
| 1 | Exhaust Slide Assembly | 4001133 | 35 | Module Gasket—Left | 4000181 |
| 2 | Exhaust Slide Gasket | 4000176 | 36 | Olive Nut for Pilot Pipe | 220K913 |
| 3 | Fan Closure Plate | 4001136 | 37 | Pipe—Valve to Pilot | 4001838 |
| 4 | Port Cover | 4001820AH | 38 | Thermal Switch Retainer | 4001519 |
| 5 | Log Support | 4001841 | 39 | Valve Mounting Bracket | 4000141 |
| 6 | Side Bricks Anchors (2) | 4001283 | 40 | Switch Bracket | 4001070 |
| 7 | Top Mounting Bracket | 4000136BY | 41 | Valve to Main Burner Pipe Connector | 220K891 |
| 8 | Side Mounting Brackets (2) | 4000135BY | 42 | Thermocurrent Interruptor | 4001037 |
| 9 | Window Assembly | 4001378 | 43 | GV60 Valve by-pass 125 | 4000873 |
| 10 | Burner Assembly NG | 4001375S | 44 | Inlet Brass Connector | 4000746 |
| | Burner Assembly LPG | 4001376S | 45 | GV60 Valve Assembly | 4000873X |
| 11 | Burner Rail NG | 4001665 | | | |
| | Burner Rail LPG | 4001666 | | | |
| 12 | Injector Elbow (Main Burner) NG | 4000738 | 47 | Switch with Cable | 4001036 |
| | Injector Elbow (Main Burner) LPG | 9730007 | 48 | Cable Interruptor | 4001035 |
| 13 | Air Shutter Cover NG | 4002346 | 49 | Ignition Cable 500 mm | 4001039 |
| 13a | Air Shutter Slider NG | 4002345 | 49a | Ignition Cable sleeve | 4002244 |
| 14 | Flashback Shield LPG | 3000371 | 50 | Remote Control Receiver | 4001911 |
| 14a | Air Shutter Slider LPG | 320B293 | 51 | Remote Control Handset | 4001910 |
| 15 | Burner Baffle | 4001784 | 52 | Wiring Harness | 4001187 |
| 16 | Burner Mounts (2) | 4001678 | 53 | Handset Wall Holder | 9000008 |
| 17 | Pilot Shield | 4000144 | 54 | Log Set Complete | 4001696 |
| 18 | Pilot Assembly NG | 4000062S | 55 | Rear Log | 4001697 |
| | Pilot Assembly LPG | 4000063S | 56 | Front Left Log | 4001699 |
| 19 | Pilot Bracket | 720A542 | 57 | Front Right Log | 4001700 |
| 20 | Pilot Injector NG—No 35 | 4002511 | 58 | Right Cross Log | 4001701 |
| | Pilot Injector LPG—No 27 | 720A195 | 59 | Middle Cross Log | 4001698 |
| 21 | Hooked Olive for Pilot Injector | 720A196 | 60 | Left Cross Log | 4001772 |
| 22 | Olive Nut for Pilot Pipe | 420K385 | 61 | Loose Coals | 4001843 |
| 23 | Electrode | 720A543 | 62 | Brick Set Complete | 4001515 |
| 24 | Electrode Retaining Nut | 720A200 | 63 | Rear Brick Panel | 4001811 |
| 25 | Thermocouple | 4000061 | 64 | Left Brick Panel | 4001809 |
| 26 | Pilot Gasket A | 4000139 | 65 | Right Brick Panel | 4001810 |
| 27 | Pilot Mount | 4000138 | | | |
| 28 | Pilot Gasket B | 4000140 | | | |
| 29 | Burner Tray | 4001676 | | | |
| 30 | Pipe—Valve to Main Burner (incl. olive & nuts) | 4000065 | | | |
| 31 | Burner Plate Access Panel | 4001680 | | | |
| 32 | Module Gasket—Rear | 4000175 | | | |
| 33 | Module Gasket—Right | 4000174 | | | |
| 34 | Module Gasket—Front | 4000173 | | | |

Spare Parts

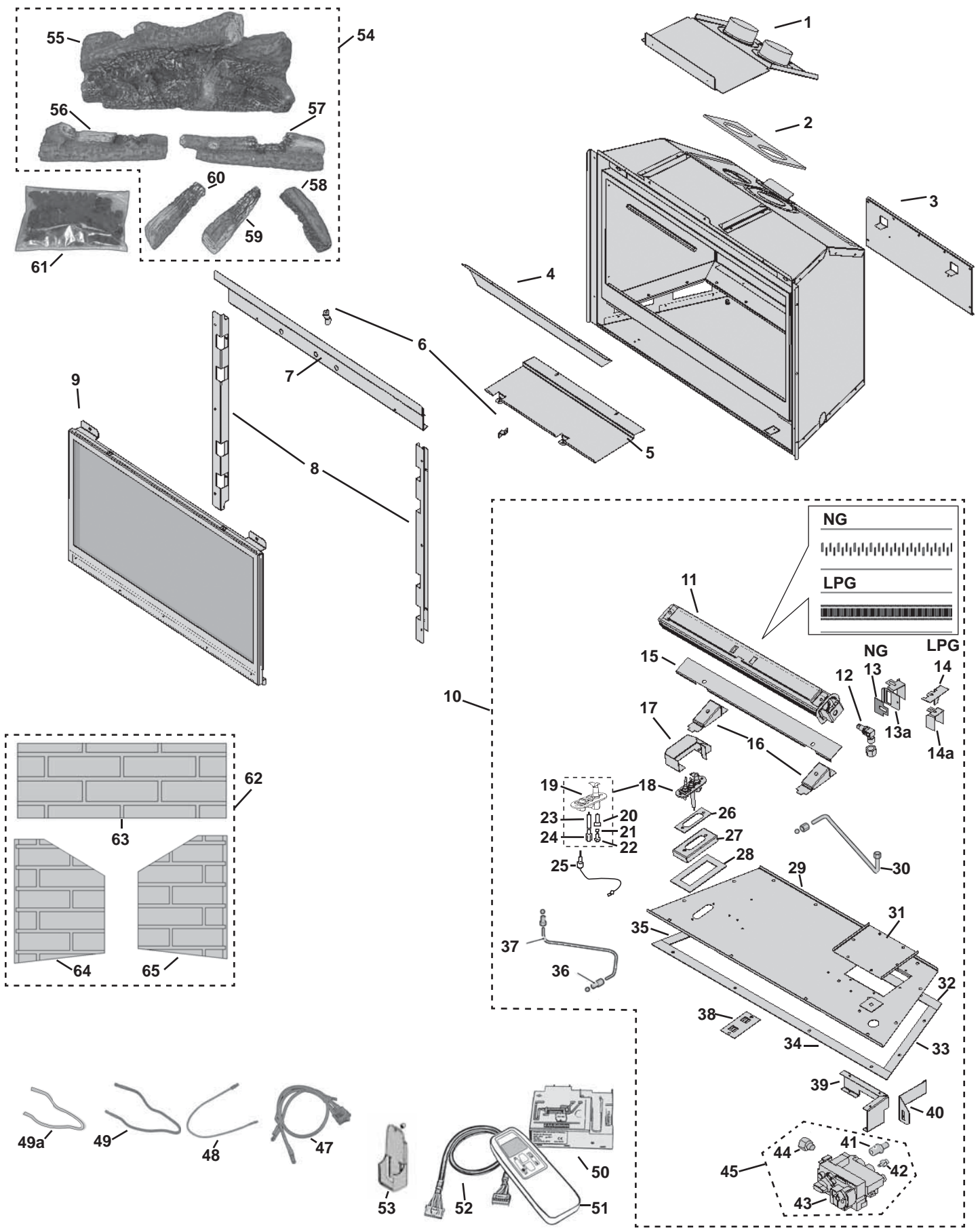

Thank You ...

For purchasing a Valor by Miles Industries. Your new radiant gas heater is a technical appliance that must be installed by a qualified dealer.



Please circle where appropriate - ask your installer or your dealer if in doubt. The information provided will be used for customer records only.

| | | | | | | | |
|---|--------------|------------|-----------------|----------------|----------------|------------------|-------|
| Model: 739IL NG (natural gas) LPG (propane) | | Serial No: | | | | | |
| Front/Trim code/description (e.g. 743FVI Double Door FenderFire): | | | | | | | |
| Purchase date (mm-dd-yyyy): | | | | | | | |
| Home Owner Name: | | | | | | | |
| Address: | | | | | | | |
| City: | | | Province/State: | | | Postal Code/Zip: | |
| Phone: () | | | Email Address: | | | | |
| Store Type: | | Fire shop | Hardware | Contractor | Other | | |
| Purchase Decision: | | Male | Female | Both | | | |
| Age: | Under 30 | 30-39 | 40-49 | 50-59 | 60+ | | |
| Heard of this product through: | | | | | | | |
| | Friend | Brochure | Advertising | Mailing | Store | Internet | Other |
| Installation Type: | | | | | | | |
| | New home | Renovation | Other | | | | |
| Reason for Purchase: | | | | | | | |
| Performance | Flame Appeal | Design | Control | Previous owner | Recommendation | Price | Other |
| Dealer Name: | | | | | | | |
| Address: | | | | | | | |
| City: | | | Province/State: | | | Postal Code/Zip: | |
| Phone: () | | | | | | | |

Cut out page, fill information, and mail to Miles Industries Ltd.

Online Warranty registration at www.valorfireplaces.com



Tape Shut



Fold here



Postage
needed

Miles Industries Ltd.
190 - 2255 Dollarton Highway
North Vancouver, BC V7H 3B1
Canada

Online Warranty registration at www.valorfireplaces.com



Thank you for choosing a Valor Product