

# Installation Manual



# G3.5

Direct Vent Insert  
Gas Fireplace  
natural gas 700MN  
propane gas 700MP

with  
**AutoFire™**

Canadian Patent 2,717,779 Issued October 24 2017  
US Patent 10,060,624 Issued August 28 2018  
US Patent 10,935,246 Issued March 2 2021

Installer: Place model/serial number here.

Installer: Leave this manual with the appliance.  
Consumer: Retain this manual for future reference.

**⚠ WARNING:**  
**FIRE OR EXPLOSION HAZARD**  
Failure to follow safety warnings exactly could result in serious injury, death, or property damage.

Do not store or use gasoline or other flammable vapors and liquids in the vicinity of this or any other appliance.

#### WHAT TO DO IF YOU SMELL GAS

- Do not try to light any appliance.

- Do not touch any electrical switch; do not use any phone in your building.
- Leave the building immediately.
- Immediately call your gas supplier from a neighbor's phone. Follow the gas supplier's instructions.
- If you cannot reach your gas supplier, call the fire department.

Installation and service must be performed by a qualified installer, service agency or the gas supplier.

## **⚠ DANGER**



Hot glass will cause burns.  
Do not touch glass until cooled.  
Never allow children to touch glass.

A barrier designed to reduce the risk of burns from the hot viewing glass is provided with this appliance and must be installed for the protection of children and other at-risk individuals.

**This appliance may be installed in an after-market permanently located, manufactured (mobile) home where not prohibited by local codes. This appliance is only for use with the type of gas indicated on the rating plate. This appliance is not convertible for use with other gases, unless a certified kit is used.**

**INSTALLER: Leave this manual with the appliance.**

**CONSUMER: Retain this manual for future reference.**

#### **Massachusetts:**

The piping and final gas connection must be performed by a licensed plumber or gas fitter in the State of Massachusetts. Also, see Carbon Monoxide Detector requirements in the fireplace installation manual.

#### **⚠ WARNING**

This product can expose you to chemicals including Benzene, which is known to the State of California to cause cancer and birth defects or other reproductive harm. For more information go to [www.P65Warnings.ca.gov](http://www.P65Warnings.ca.gov).

Note: Natural gas, in its original state, contains Benzene.

This manual contains instructions to install the **ENGINE ONLY**. A trim kit is **REQUIRED** to complete the installation. A barrier screen is provided with the trim kit. **Refer to the manual supplied with the trim for installation.**

**This appliance is a domestic room-heating appliance. It must not be used for any other purposes such as drying clothes, etc.**

**This appliance is suitable for installation in a bedroom or bed sitting room.**

Ce guide est disponible en français sur demande.



We recommend a US Certified National Fireplace Institute (NFI) specialist install our gas hearth products.



The information contained in this manual is believed to be correct at the time of printing. Miles Industries Ltd. reserves the right to change or modify any information or specifications without notice. Miles Industries Ltd. grants no warranty, implied or stated, for the installation or maintenance of your heater, and assumes no responsibility for any consequential damage(s).

© Copyright Miles Industries Ltd., 2021. All rights reserved.  
Designed and manufactured for Miles Industries Ltd.

# Welcome to Valor®

This appliance has been professionally installed by:

Dealer Name: \_\_\_\_\_

Phone: \_\_\_\_\_

**Please read this manual BEFORE installing and operating this appliance.**

<b>Fireplace Safety .....</b>	<b>4</b>
<b>Specifications .....</b>	<b>6</b>
<b>Kits &amp; Accessories.....</b>	<b>7</b>
<b>Dimensions.....</b>	<b>8</b>
<b>Installation Planning.....</b>	<b>9</b>
Clearances.....	9
Before Installation.....	10
Overview .....	11
<b>Venting.....</b>	<b>12</b>
Overview .....	12
<b>Preparation .....</b>	<b>13</b>
Existing Fireplace Preparation.....	13
<b>Installation .....</b>	<b>14</b>
Window and Fan.....	14
Venting.....	15
Gas Supply.....	16
Liners .....	18
Fuel Beds .....	20
Install Birch Log Kit 700BLK.....	20
Install Traditional Log Kit 700LSK .....	23
Install Driftwood Log Kit 700DWK.....	26
Window Re-Installation & Checking .....	29
Remote Control Pairing.....	30
Check Operation and Aeration.....	31
Front Trim.....	32
Remote Control Holder.....	33
GV60 Wiring Diagram .....	34
<b>Approved Venting Components .....</b>	<b>35</b>
<b>Appendix A—Lighting Instructions.....</b>	<b>36</b>
<b>Appendix B—Remote Control Operation ....</b>	<b>37</b>
<b>Appendix C—Spare Parts .....</b>	<b>41</b>

# Fireplace Safety

This manual contains very important information about the safe installation and operation of the fireplace. Read and understand all instructions carefully before installing and operating the fireplace. Failure to follow these instructions may result in possible fire hazard and will void the warranty.

Replacement manuals are available by contacting the Valor Customer Service at 1-800-468-2567, or by visiting [valorfireplaces.com](http://valorfireplaces.com).

## **WARNING: Extremely Hot!**

### Heat and flammability

- Some parts of the fireplace are extremely hot, particularly the glass window. Use the barrier screen provided or a gate to reduce the risk of severe burns.
- The glass windows can exceed 500°F at full capacity.
- Always keep the appliance clear and free from combustible materials, gasoline, and other flammable vapors and liquids.
- Be aware of hot wall surfaces! The wall directly above the fireplace can get very hot when the fireplace heats. Although safe, it may reach temperatures in excess of 200°F (93°C) depending on choice of optional accessories. Do not touch!
- Be aware of hot hearth/floor surfaces! Any projections directly around the fireplace can get very hot when the fireplace heats. Although safe, they may reach temperatures in excess of 200°F (93°C) depending on elevation of hearth. Be careful of touching these! Temperature of projection surfaces will be reduced when barrier screens are installed.
- Some materials or items, although safe, may discolor, shrink, warp, crack, peel, and so on because of the heat produced by the fireplace. Avoid placing candles, paintings, photos and other combustible objects sensitive to heat or furniture within 36 inches (0.9 m) around the fireplace.
- Solid wood flooring in front of the fireplace (if allowed) may shrink during the heating season due to heat.
- Any safety screen, guard, or barrier removed for servicing an appliance must be replaced prior to operating the appliance

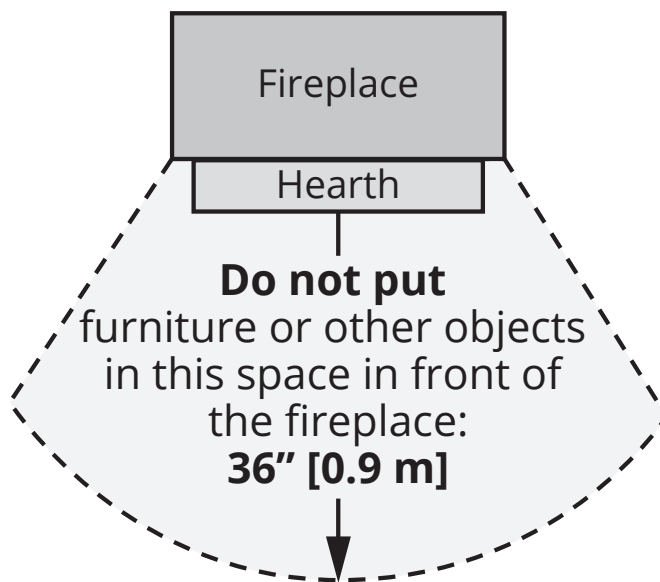

- Due to its high temperatures, the appliance should be located out of traffic areas and away from furniture and draperies.
- Children and adults should be alerted to the hazards of high surface temperature and should stay away to avoid burns or clothing ignition.
- Young children should be carefully supervised when they are in the same room as the appliance. Toddlers, young children, and others may be susceptible to accidental contact burns. A physical barrier is recommended if there are at-risk individuals in the house. To restrict access to a fireplace or stove, install an adjustable safety gate to keep toddlers, young children, and other at-risk individuals out of the room and away from hot surfaces.
- A barrier designed to reduce the risk of burns from the hot viewing glass is provided with this appliance and shall be installed for the protection of children and other at-risk individuals
- Clothing or flammable material should not be placed on or near the appliance.

# Fireplace Safety

## Glass window



### **WARNING**

**Do not operate this appliance with the glass front removed, cracked, or broken. Replacement of the glass front should be performed by a licensed or qualified service person. Do not strike or slam the glass front.**

- The glass front assembly must be in place and sealed before the unit can be placed into safe operation.
- The glass front assembly must only be replaced as a complete unit, as supplied by the fireplace manufacturer. No substitute material may be used.
- Do not use abrasive cleaners on the glass front assembly. Do not attempt to clean the glass when it is hot.

## Venting

- This unit must be used with a vent system as described in this manual. No other vent system or components may be used.
- Never obstruct the flow of combustion and ventilation air. Keep the front of the appliance clear of all obstacles and materials for servicing and proper operation.
- This gas fireplace and vent assembly must be vented directly to the outside and must never be attached to a chimney serving a separate solid fuel burning appliance. Each gas appliance must use a separate vent system. Common vent systems are prohibited.

## Intended use

- This appliance is designed and approved as a supplemental heater and provides the potential for most energy conservation when used while attended. The use of an alternate primary heat source is advisable.
- This unit is not for use with solid fuel.
- Do not use this heater as a temporary source of heat during construction.

## Installation and Servicing

- Installation and repair should be done by a qualified service person. The appliance should be inspected before use and at least annually by a professional service person. More frequent cleaning might be required due to excessive lint from carpeting, bedding material, et cetera. It is imperative that control compartments, burners, and circulating air passageways of the appliance be kept clean.

# Specifications

## Approval & Codes

This appliance is certified to ANSI Z21.88/CSA 2.33 American National Standard / CSA Standard for Vented Gas Fireplace Heaters for use in Canada and USA, and to CGA 2.17-91 High Altitude Standard in Canada. This appliance is for direct vent installations.

This appliance complies with CSA P.4.1-15 Testing method for measuring annual fireplace efficiencies.

The installation must conform to local codes or, in the absence of local codes, with the National Fuel Gas Code, ANSI Z223.1/NFPA 54 or the Natural Gas and Propane Installation Code CAN/CGA-B149.1. Only qualified licensed or trained personnel should install this appliance.

This appliance must be electrically grounded in accordance with local codes, or, in the absence of local codes, with the National Electrical Code, ANSI/NFPA 70 or the Canadian Electrical Code, CSA C22.1.

## Ratings

Model	700MN	700MP
Gas	Natural	Propane
Altitude (Ft.)*	0-4,500 feet*	
Input Maximum (Btu/h)	26,000	26,000
Input Minimum (Btu/h)	13,000	11,000
Manifold Pressure (in w.c.)	3.5"	10"
Minimum Supply Pressure (in w.c.)	5"	11"
Maximum Supply Pressure (in w.c.)	10"	14"
Main Burner Injector Marking	750	260
Pilot Injector Marking	51	30
Min. Rate Bypass Screw	175	105

## \*High Altitude Installations

Input ratings are shown in BTU per hour and are certified without deration for elevations up to 4,500 feet (1,370 m) above sea level.

For elevations above 4,500 feet (1,370 m) in USA, installations must be in accordance with the current ANSI Z223.1 and/or local codes having jurisdiction. Heating value of gas in some areas is reduced to compensate for elevation—consult your local gas utility to confirm.

For installations at elevations above 4,500 feet (1,370 m) in Canada, please consult provincial and/or local authorities having jurisdiction.

## Supply Gas

Heater engine 700MN uses natural gas.  
Heater engine 700MP uses propane gas.

The supply pressure must be between the limits shown in the *Ratings* section.

The supply connection is 1/2" NPT female and located on the left side of the control valve. The gas line entry point is on the the upper left hand side of the fireplace. See *Gas Supply Installation* section for details.

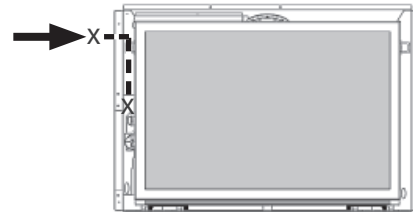

## Electrical

The 700M is designed to run on battery power and does not require an electrical source to operate as a heater. However, if the appliance is fitted with a fan, a grounded power source is required.

## Gas Conversion Kits

The 700M is supplied as natural gas or propane gas and is field convertible between fuels. See instructions packaged with the conversion kits for further information.

## Floor/Hearth

This appliance is approved for installation into existing solid-fuel burning fireplaces only. Combustible material such as plywood and so on may be used for leveling and shimming beneath the unit. This appliance does not require a hearth other than to support the weight of certain fronts.

## Outdoor Conversion Kit

The 700M models are supplied standard for indoor applications and may be adapted for installation in specific "outdoor" applications protected from weather as defined in the GV60CKO outdoor conversion kit manual.

**Note:** This appliance is designed and approved as a supplemental heater and provides the potential for most energy conservation when used while attended. The use of an alternate primary heat source is advisable.

# Kits & Accessories

## Required Kits

Fuel Beds (choose one)		
700LSK	Traditional Log Set	
700DWK	Driftwood Log Set	
700BLK	Birch Log Set	
Liners (choose one)		
705LSLV3	Ledgestone Panels	
706RGL	Reflective Glass Panels	
707FBL	Fluted Black Panels	
708VRL	Valor Red Brick Panels	
Fronts (choose one)		Barrier Screen
709FT	Floating Trim Kits 3 Sided	4003381
709FTB	Black	
709FTP	Polished	
709FTV	Vintage iron	
709FTZ	Bronze	
713FF	Floating Trim Kits 4 Sided	4007965AZ
713FFB	Black	
713FFV	Vintage iron	
716EC	Edgemont Craftsman Fronts	4003834
716ECBR	Bronze	
716ECPW	Pewter	
716ECCB	Champagne Brass	
721ED	Edgemont Fronts	4003834
721EDN	Polished	
721EDV	Vintage iron	
721EDZ	Bronze	
Backing Plates (choose one)		
717BPB (3-sided floating)	36-1/4" W x 26-5/8" H	Required backing plates black for 716 & 721
717BPBF (3-sided flat)	37-3/8" W x 27-1/4" H	
719BPB (4-sided floating)	36-1/4" W x 29-1/4" H	

## Optional Accessories

Riser Trims (choose one)	
725RTB 793RTB	Riser trim black for 3 sided fronts
793RTV	Riser trim vintage iron for 3 sided fronts
Backing Plates (choose one)	
710BPB 714BPB	Optional backing plates black for 709 & 713
Gas Conversion Kits	
700MNGK	Conversion Kit to Natural Gas
700MPGK	Conversion Kit to Propane Gas
Other Accessories	
795CFKV2	Circulating Fan Kit
1265WSK	Wall Switch Kit
RBWSK	Remote Battery & Wall Switch Kit
GV60CKO	Outdoor Fireplace Conversion Kit
Hearth Gate	Hearth gates such as Cardinal's VersaGate are available at retail stores carrying safety products for children.



### WARNING

**Optional electrical accessories ARE NOT ALLOWED when adapting appliance for outdoor use.**

# Dimensions

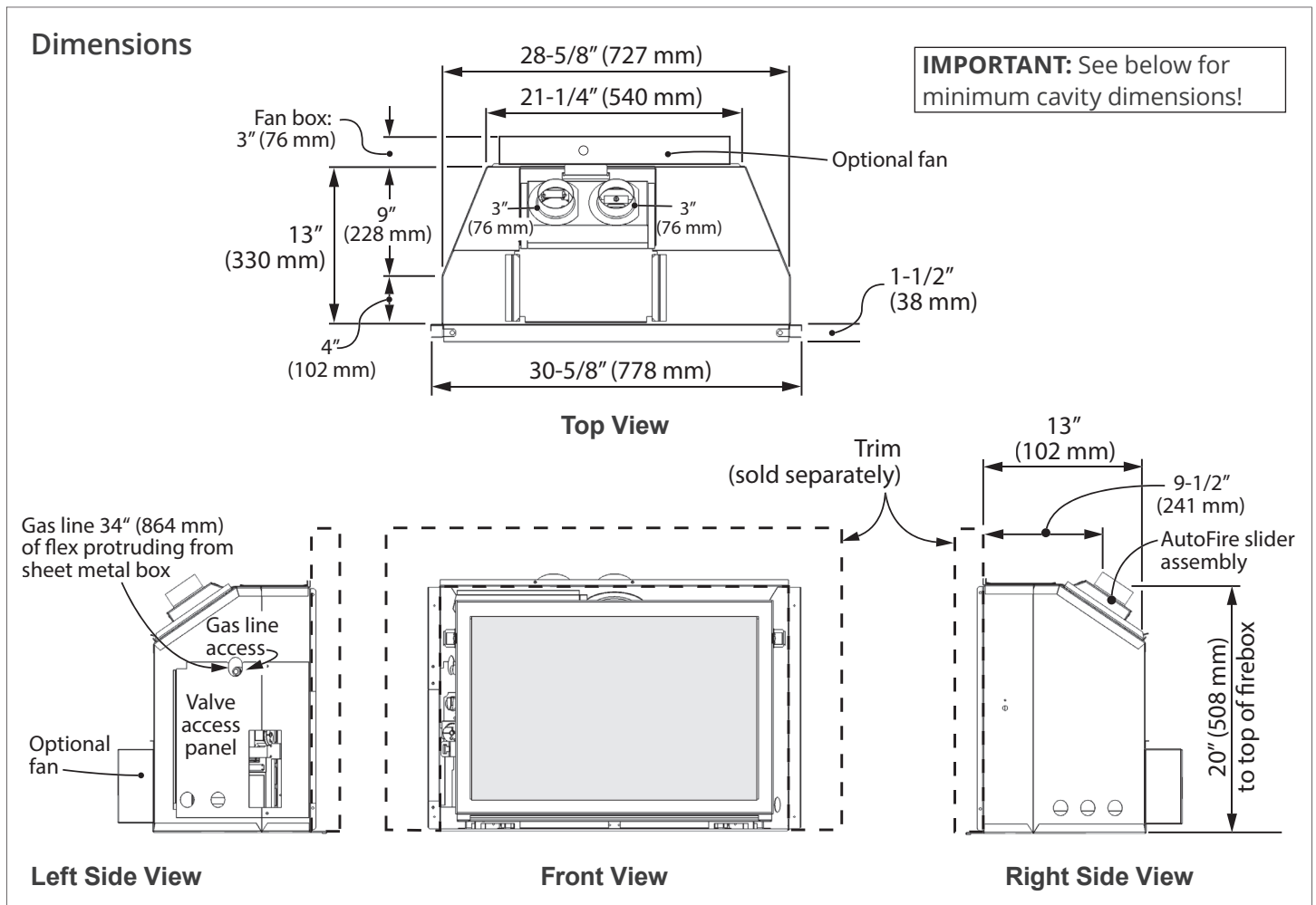

## Cavity

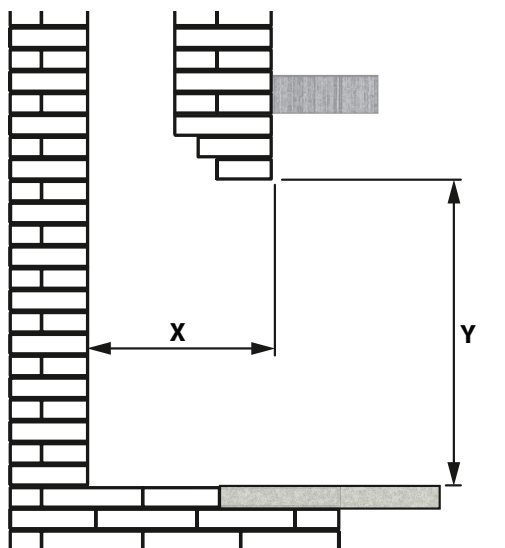

## Minimum Cavity Dimensions

Check that masonry step does not interfere with install dimensions or vent pipe.

If mantel is combustible, see the following section for allowable clearances.

A hearth is not required, although any hearth/floor within 4" of the bottom of the unit must be non-combustible.

Minimum Dimension	With 717BPBF (Flat Plate)	With All Other (Floating) Backing Plates
Depth (X)	14-1/2" [368 mm]	13-1/2" [343 mm]
Depth with fan (X)	17-1/2" [445 mm]	16-1/2" [420 mm]
Height (Y)	22-3/8" [521 mm]	20-1/2" [521 mm]
Width (not shown)	30-7/8" [784 mm]	28-7/8" [734 mm]



# Installation Planning

## Clearances

### Combustible Mantel—Left Side View

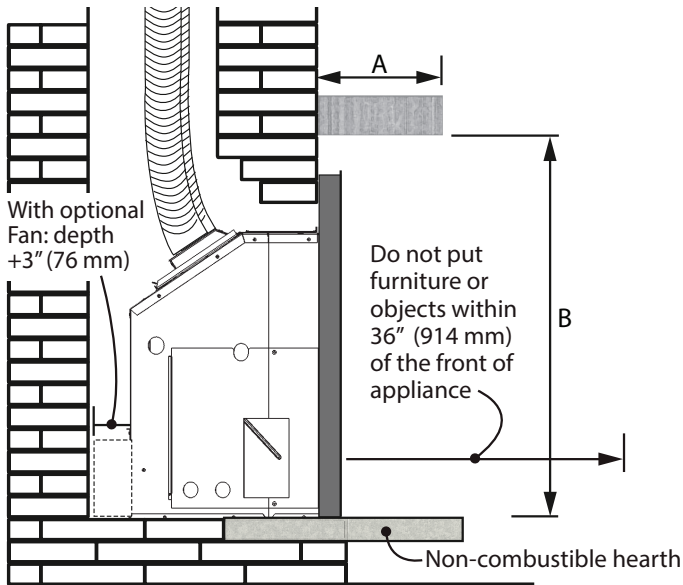

### Combustible Mantel Clearances

<b>Mantel Pro- jection A</b>	0-6" (0-152 mm)	8" (203 mm)	10" (254 mm)	12" (305 mm)
<b>Mantel Height B*</b>	33" (838 mm)	35" (890 mm)	37" (940 mm)	39" (990 mm)

\*Measure taken from the underside of the mantel to finished hearth or surface that the unit is sitting on.

### Finishing Materials

**Combustible materials:** Materials made of or surfaced with wood, compressed paper, plant fibers, plastics, or other material that can ignite and burn, whether flame proofed or not, or plastered or unplastered.

**Non-combustible materials:** Material which will not ignite and burn. Such materials are those consisting entirely of steel, iron, brick, tile, concrete, slate, glass or plasters, or any combination thereof.

Materials that are reported as passing ASTM E 136, Standard Test Method for Behavior of Materials in a Vertical Tube Furnace at 750 °C

#### **⚠ WARNING**

**HOT GLASS!** The use of a screen in front of the glass is highly recommended particularly in households with children.

### Sidewall Clearances

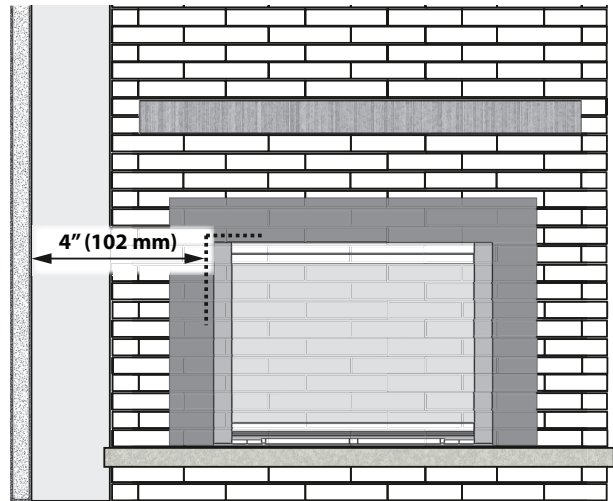

**Minimum** distance from side of appliance (liner box) to combustible wall: 4" (102 mm).

### Floor/Hearth Clearances

Combustible shims/supports may be used beneath the appliance to level or raise the appliance within the existing fireplace cavity.

Combustible flooring/hearths **in front** of the appliance must be at a minimum of 4" (102 mm) below the bottom of the appliance. The gas insert does not require a hearth.

#### **⚠ WARNING**

**Some materials or items, although safe, may discolor, shrink, warp, crack, peel, and so on because of the heat produced by the fireplace. Avoid placing candles, paintings, photos, and other items sensitive to heat around the fireplace.**

#### **⚠ WARNING**

**HOT HEARTH / FLOOR!** The hearth or floor in front of the fireplace may become very hot when the fireplace heats. Do not use the hearth as a seat or shelf. Solid wood flooring in front of the fireplace (if allowed) may shrink during the heating season due to heat.

# Installation Planning

## Before Installation



### Caution

Only qualified, licensed, or trained personnel should install this appliance.

### Installer - READ THIS FIRST!

1. YOU NEED TO KNOW FROM THE HOMEOWNER:
  - What accessories (surround, screen, fan\*, etc) will be installed
2. Unpack the appliance, removing all items packed inside and around it. Recycle the packaging.
3. Check that you have everything, using the Pack Content sheet. Also, check that you have:
  - Fuel bed (packed separately)
  - Liner panels (packed separately)
  - Optional accessories (if ordered)
  - Gas conversion kit (if necessary)
  - Venting accessories
  - Electrical accessories (if used)
4. Carefully read the Installer's Checklist included with the fireplace for the installation sequence.

### Note

\* If installing a fan, you will need to use the remote control to test the fan operation. In this case, put batteries in the handset and the battery holder and set up the remote control.

Electrical connections must be done BEFORE the appliance is placed in its final position, since the connections are done from the back of the appliance.



### WARNING

**Optional electrical accessories ARE NOT ALLOWED when adapting appliance for outdoor use.**

# Installation Planning

## Overview

This appliance may ONLY be installed in an existing unaltered, functioning solid-fuel burning fireplace with a working flue and constructed of non-combustible material.

This appliance may be installed in outdoor, weather protected environments as defined in the GV60CKO Outdoor Conversion Kit instruction manual.

DO NOT install into combustible construction. This appliance is NOT APPROVED for installation with a zero clearance kit.

### WARNING

Some materials or items, although safe, may discolor, shrink, warp, crack, peel, and so on because of the heat produced by the fireplace. Avoid placing candles, paintings, photos, and other items sensitive to heat around the fireplace.

### WARNING

**HOT HEARTH / FLOOR!** The hearth or floor in front of the fireplace may become very hot when the fireplace heats. Do not use the hearth as a seat or shelf. Solid wood flooring in front of the fireplace (if allowed) may shrink during the heating season due to heat.

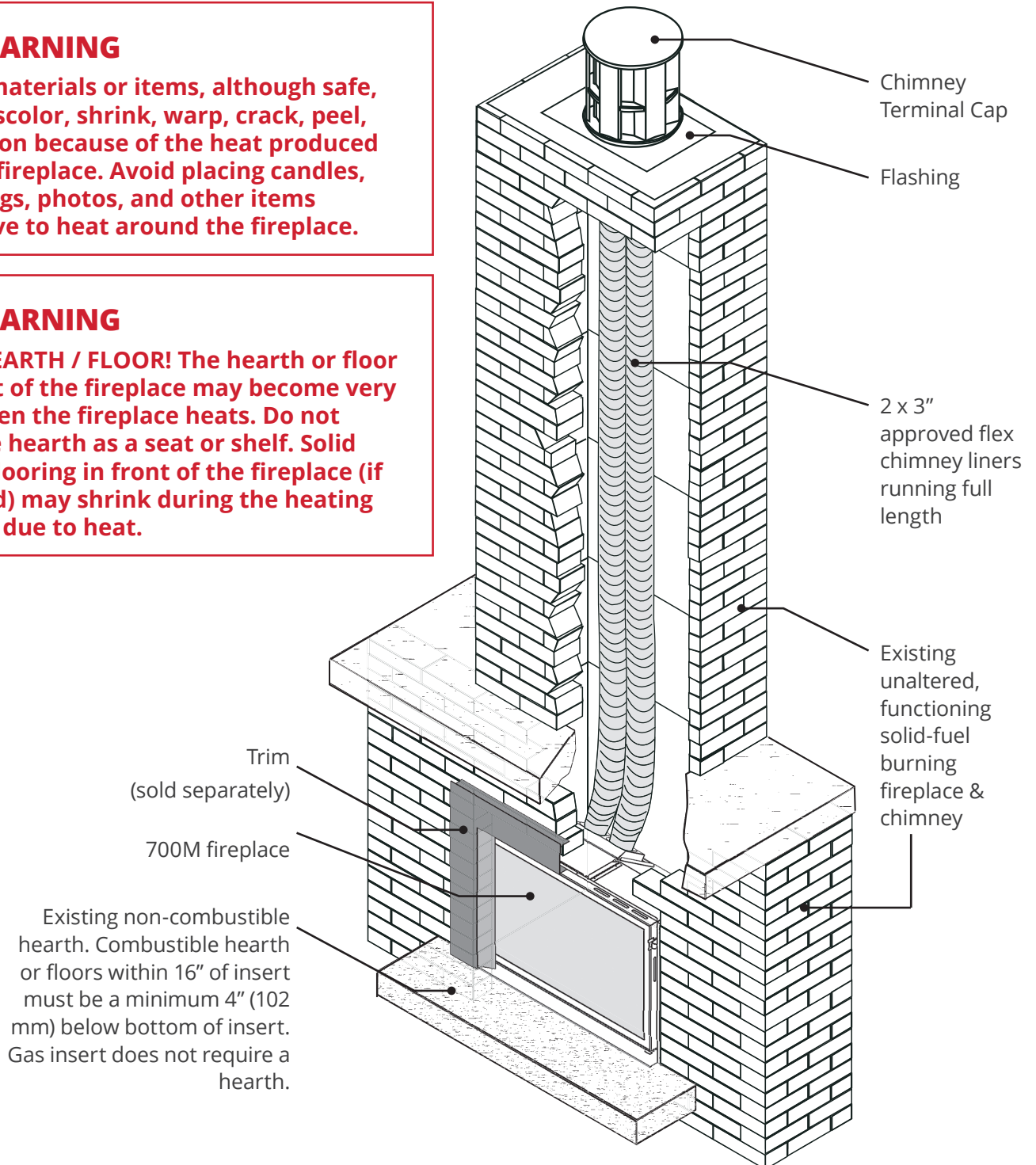

# Venting

## Overview

### Typical Vent Installation

**NOTE:** Flexible co-linear vent pipes may only be installed into existing non-combustible solid-fuel burning fireplaces and chimneys.

See list of approved Venting Accessories on page 41 of this manual. The appliance must not be connected to a chimney flue serving a separate solid-fuel burning appliance.

The required fireplace dimensions and clearances are shown in *Dimensions* (page 8) and *Clearances* (page 9) sections of this manual.

### Vent Location

The vent terminal must be located through the roof. This direct vent appliance is designed to operate when an undisturbed airflow hits the outside vent terminal from any direction.

Check local codes for allowable vertical vent termination.

### Venting Table

Maximum vertical height	40 ft (measured to bottom of termination)
Minimum vertical height	10 ft (measured to bottom of termination)
Maximum horizontal run	4 ft (measured center to center of pipe)
Maximum offset angle	45° (sweeping bend to allow for obstructions)

### Venting Notes

Where possible, avoid joining flex pipes. If joints are required, use an approved connector and seal joints with RTV high temp sealant.

Horizontal offset is permissible to allow for routing around masonry projections. Avoid bending flex pipe over a 45 degree radius where possible.

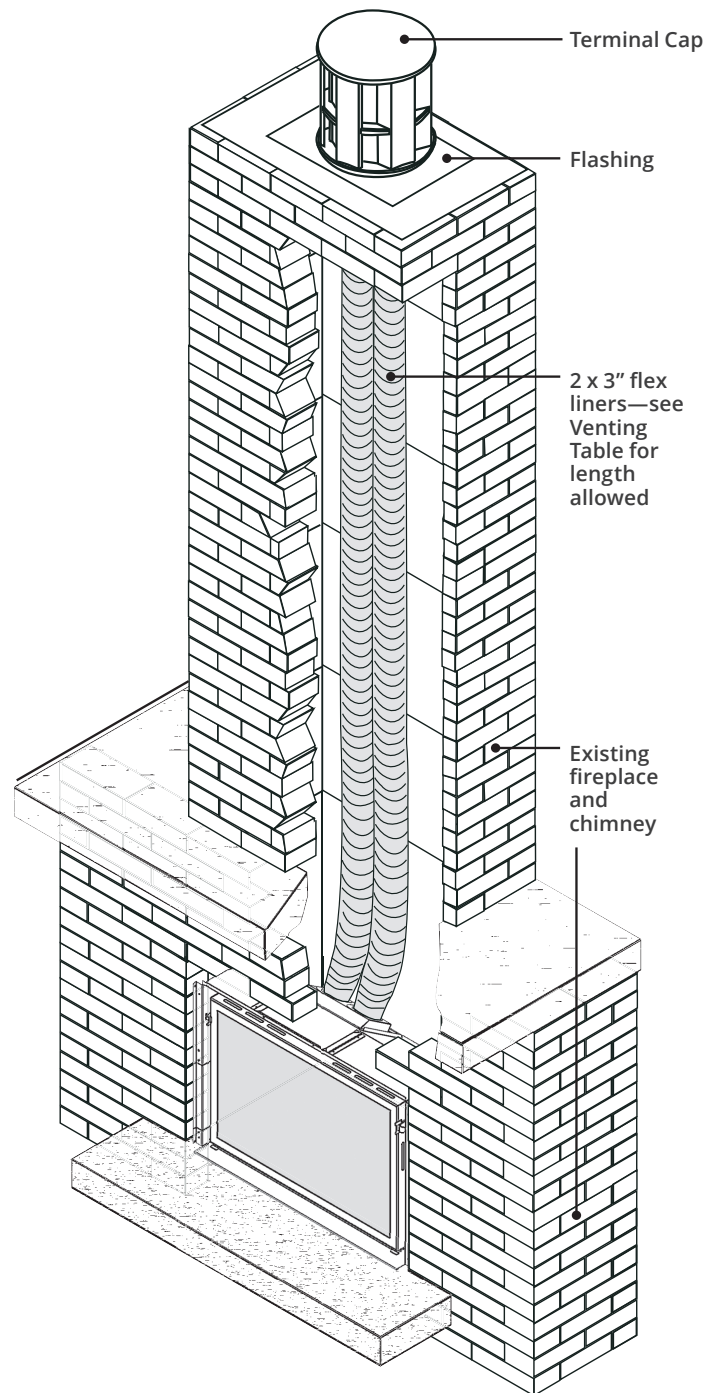
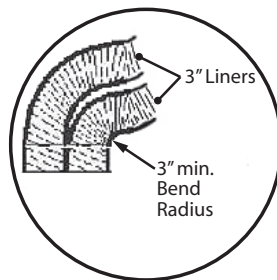

# Preparation

## Existing Fireplace Preparation

A few points must be considered before inserting the 700 into an existing fireplace cavity. Generally, no modifications are allowed to the existing fireplace that will compromise the integrity of the existing fireplace.

Components that are bolted or screwed on such as dampers or baffles may be removed to accommodate the installation of the 700 engine. Cutting away any sheet metal parts of the existing fireplace to accommodate the installation of the 700 is prohibited.

Check with local authorities if in doubt.

## Clean Fireplace and Chimney

Have the chimney swept and the fireplace cavity including ash dumps and clean-outs cleaned before installing the 700 heater and vent liners. Any creosote or soot residue remaining in the fireplace cavity chimney or clean-out may cause odors or stains once the 700 insert is installed. Consult with chimney sweep for information on how best to clean.

## Existing Dampers

Factory-built, zero-clearance fireplaces will require the damper to be removed in order to install the vent liners. These dampers are usually bolted into place. Dampers in masonry fireplaces must be fixed open and may remain in place.

## Ash Retaining Curbs

Some fireplaces (particularly factory-built) have a raised curb at the front edge to retain ashes. Check the dimensions carefully to ensure the 700 engine will fit behind any raised curb (some curbs may be removed separately from the refractory base).

## Existing Fireplace Preparation

### Gas Line Routing

Plan the routing of the gas line before proceeding. Utilize the existing hole for the gas line of the factory-built fireplace.

If the fireplace has no access hole, carefully drill an access hole of 1.5 inch (38 mm) or less through the lower sides or bottom of the firebox. The access hole must be plugged with non-combustible insulation after the gas supply line has been installed.

See Dimensions section for detailed location of gas inlet. Also, take into consideration whether or not a fan or shut-off valve will interfere when planning routing of the gas line.

### Existing Glass Doors and Wire Screens

Existing glass doors must be permanently removed prior to installing the 700 insert.

### Combustible Mantels

Combustible mantel clearances must conform to those required for the original solid-fuel fireplace into which the 700 is being installed.

### Attach Warning Conversion Plate to Existing Fireplace

(plate supplied loose with 700 heater)

Attach the "This fireplace has been converted..." label to the existing fireplace using screws or other mechanical means and store any removed parts in back of the existing fireplace for future use.

# Installation

## Window and Fan

### Remove Window

The window is held in place by a spring-loaded lever on each side. To remove the window:

1. Locate the levers on each side of the window towards the top. Using your finger, pull the lever towards you and unhook it from the window frame bracket.

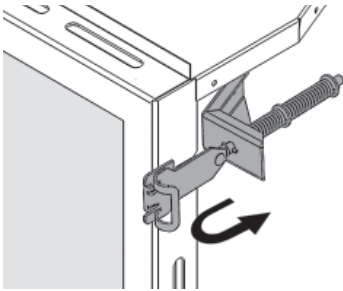

2. Gently pull the top of the window outward.

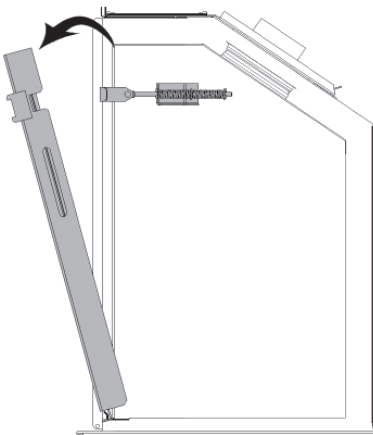

3. Lift the window out of its bottom railing and set it aside in a safe place to avoid damage.

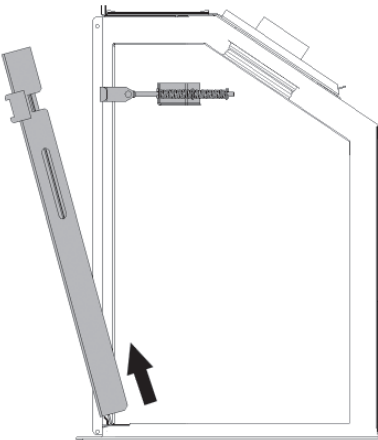

### Install Fan Kit (if used)

If the 795CFKV2 Circulating Fan Kit (blower) is to be installed, we suggest that you do it now.

The fan cavity is accessible from the back of the firebox to facilitate its installation. If the fan is retrofitted after the installation of the appliance, the appliance will need to be removed. Therefore, we recommend that, where possible, the fan be installed before the appliance is fitted into the cavity.

Refer to instructions provided with the 795CFKV2 to install the fan.

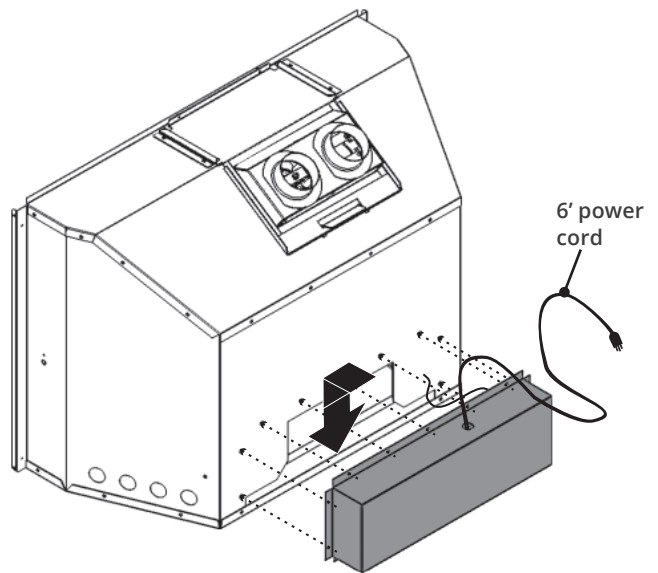

### **⚠ WARNING**

**Optional electrical accessories ARE NOT ALLOWED when adapting appliance for outdoor use.**



# Installation

## Venting

### Connect Venting

**IMPORTANT:** This appliance's venting system is room sealed and therefore does not require room air to be used in the combustion process.

1. Rough-in two 3" diameter vent liners into the existing chimney system from the roof. Be careful not to tear or damage the liners in the process. It may be easier to install both liners at the same time rather than one at a time. Leave plenty of liners at the bottom to facilitate the connection of the liners to the vent slider. **It is best to leave the top termination until later.** Designate and mark the top and bottom of one liner as "EXHAUST" to avoid confusion later.
2. Release the two screws retaining the vent slider to the front of the firebox. Remove the slider from the firebox by sliding it towards the back of the firebox.
3. Fit the two liners ensuring that the *exhaust* liner is connected to the identified "EXHAUST" vent collar. Secure liners to collars with hose clamps (included) and 2 tapping screws per liner.
4. Slide the firebox onto the vent slider in the cavity taking care not to damage the liners. **Make sure that the rear edge of the slider is hooked over the cleat on the firebox.** Secure the vent slider to the front of the firebox with two screws removed earlier.
5. From the roof, pull the liners and fit the flashing.
6. Fit the terminal cap ensuring that the *exhaust* liner is connected to the *exhaust* vent collar. Secure with screws.
7. Seal the terminal and flashing from water penetration as required.

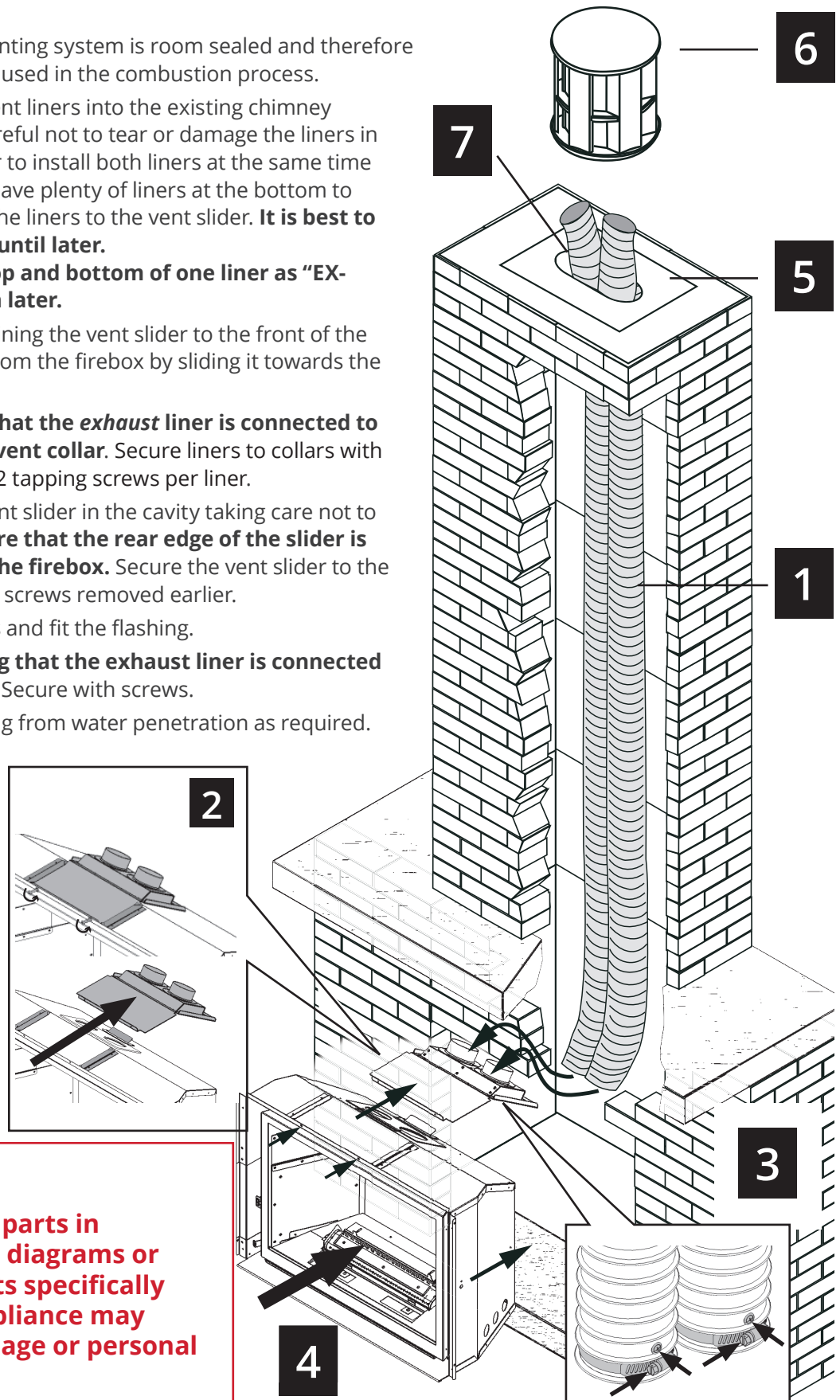

### WARNING

Failure to position the parts in accordance with these diagrams or failure to use only parts specifically approved with this appliance may result in property damage or personal injury.

### Connect Gas Supply

The gas supply inlet connection is a 1/2" NPT female. Gas shut-off valve supplied on the end of stainless steel flexible connector. Flex connector is located on the left hand rear corner of the appliance.



Use only new black iron or steel pipes, CSST, or copper tubing if acceptable—check local codes. Note that in USA, copper tubing must be internally tinned for protection against sulfur compounds.

The burner module and gas train on this appliance may be removed as a unit for servicing. The flex pipe supplied with the unit provides a union for removal of the module.

Unions in gas lines should be of ground joint type.

The gas supply line must be sized and installed to provide a supply of gas sufficient to meet the maximum demand of the appliance without undue loss of pressure.

Sealant used must be resistant to the action of all gas constituents including LP gas. Sealant should be applied lightly to male threads to ensure excess sealant does not enter gas lines.

Pressure test the supply line for leaks.

The appliance and its individual shut-off valve must be disconnected from the gas supply piping system during any pressure testing of that system at test pressures in excess of 1/2 psig (3.5 kPa).

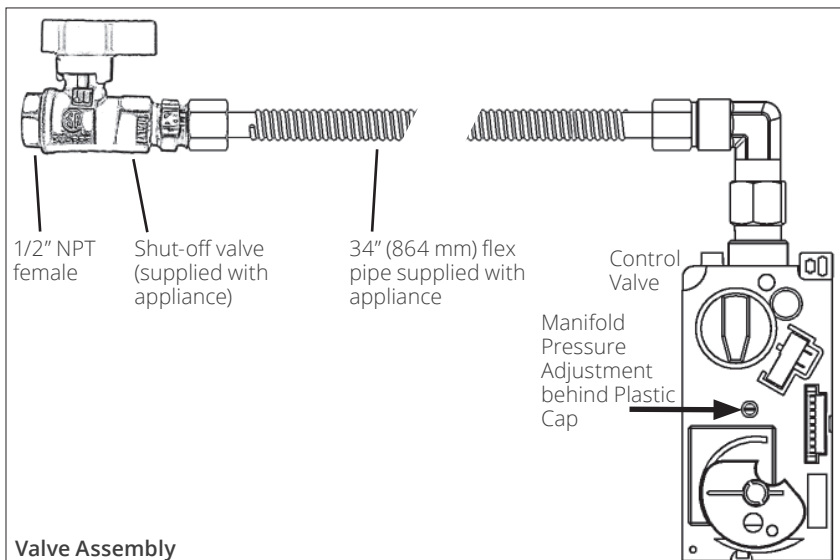

Valve Assembly

The appliance must be isolated from the gas supply piping system by closing its equipment shut-off valve during any pressure testing of the gas supply piping system at test pressures equal to or less than 1/2 psi (3.5 kPa).

Failure to either disconnect or isolate the appliance during pressure testing may result in regulator or valve damage and void the warranty. Consult your dealer in case of damage.

### Pressure Test Points

The minimum supply pressure is given in the section Specifications of this manual—page 6.

All piping and connections must be tested for leaks after installation or servicing. All leaks must be corrected immediately.

When testing for leaks:

- Make sure that the appliance is turned off.
- Open the manual shut-off valve.
- Test for leaks by applying a liquid detergent or soap solution to all joints. Bubbles forming indicate a gas leak.

**Never use an open flame to check for leaks.**  
**Correct any leak detected immediately.**

The pressure test tapping locations are shown in the figure below. An internal regulator within the valve controls the burner manifold pressure.

The correct pressure range is shown in the table in section Specifications of this manual on page 6. The pressure check should be made with the burner alight and at its highest setting. See Lighting Instructions section for full operating details on page 36.

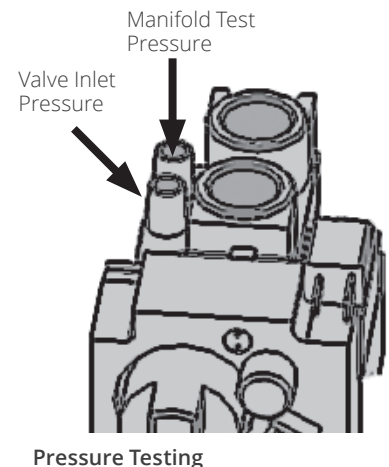



# Installation

## Gas Supply

### Inlet Connection

The appliance is supplied with a flared elbow connector fitted onto the valve and a flex connector supplied loose to be attached to the elbow connector. To facilitate the installation of the flex connector, remove the valve access panel on the left side of the appliance case.

**NOTE:** The flex connector minimum bend radius must be no smaller than the size of a golf ball (approx. 1-3/4" or 44 mm) as indicated.

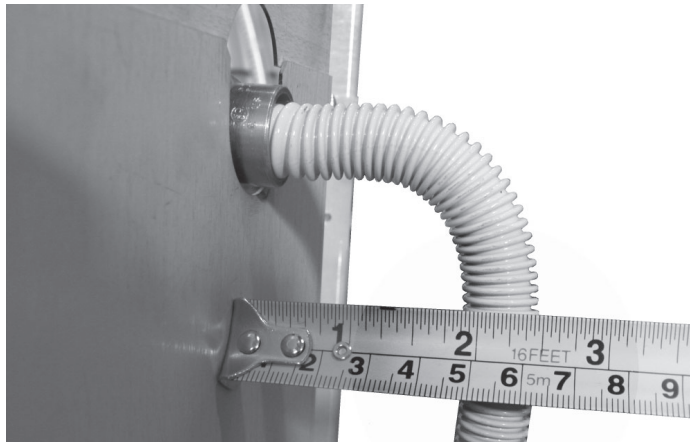
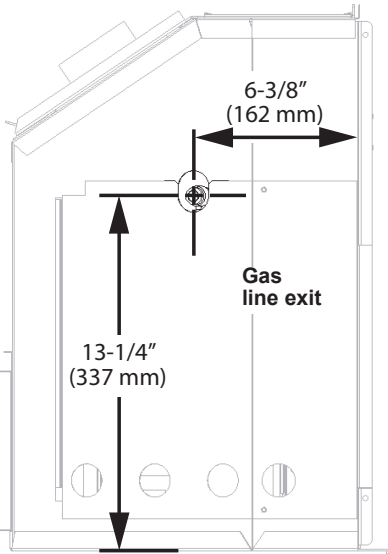

### Alternate Inlet Connection

When the fireplace opening width is too narrow, you may use common elbows and fittings (not supplied) to redirect the position of the flex connector closer to the side of the appliance.

1. Remove elbow connector.

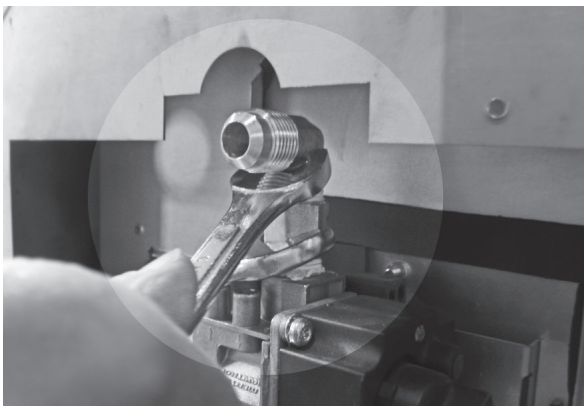

2. Install alternate elbow (not supplied).

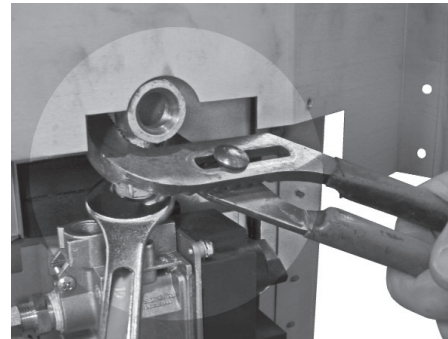

3. Re-install original supplied connector elbow.

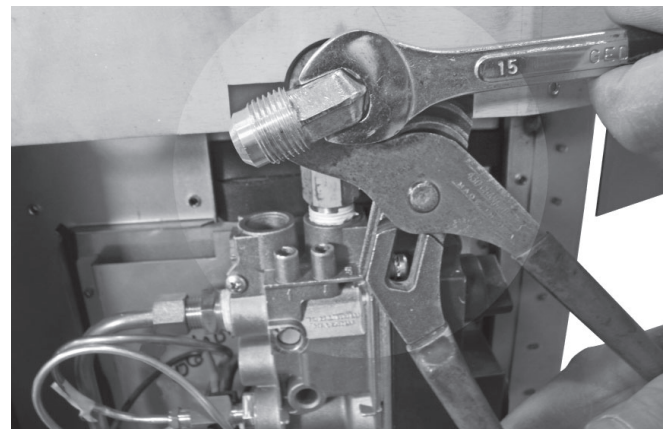

4. Install the flex connector to the alternate elbow.

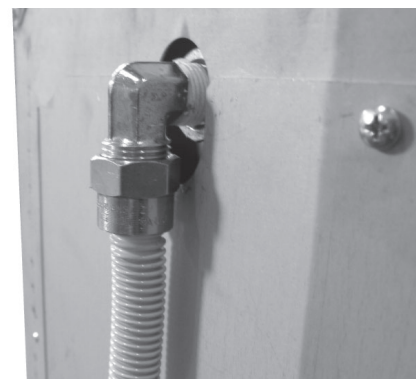

# Installation

## Liners

### Liner Installation

The following guidelines apply to all panels except 706RGL Reflective Glass Liners, for which separate instructions are provided with that kit.

Note all ceramic liner kits come with two extra base pieces. These may be disposed of, they are not installed in a 700M.

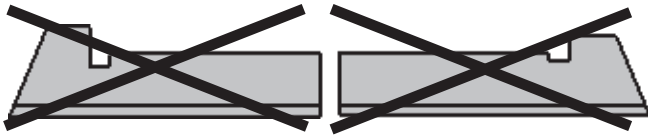

1. Remove the log support (2 screws).

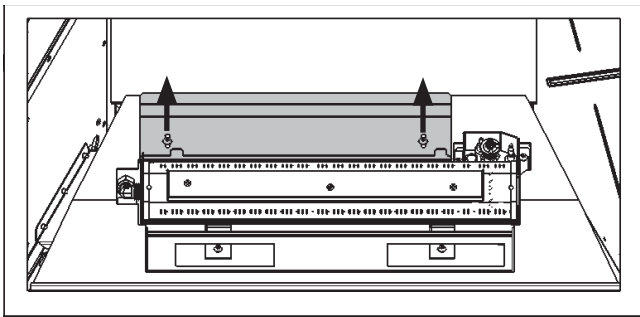

2. Remove the burner cover (2 screws).

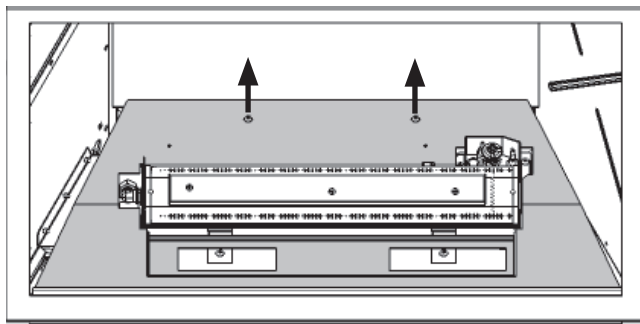

3. Inside the firebox, on the top of each side, release the screw of the side brick anchors (one per side) just enough to allow them to rotate.

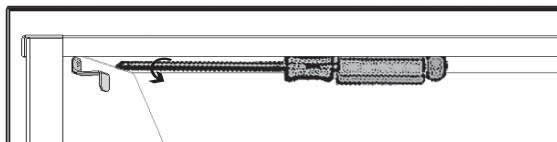

4. Install the rear panel on the rail behind the burner, against the back of the firebox. The angled edge faces the top of the firebox. Support the rear panel with your hand.

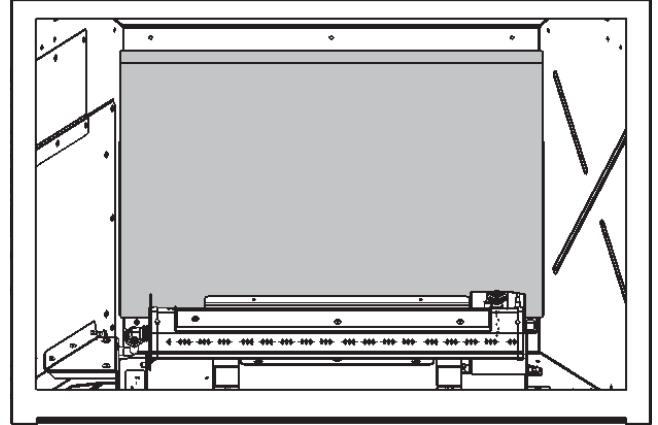

5. Install the left hand panel against the inside of the firebox, bottom edge first. Rotate the anchor down to hold the panel.

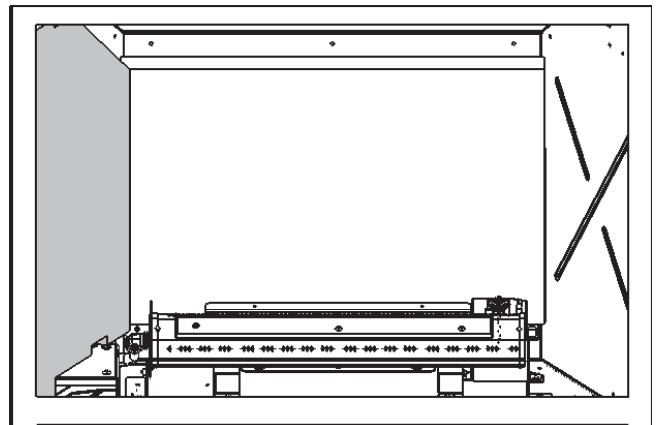

6. Install the right hand panel against the inside of the firebox, bottom edge first. Rotate the anchor down to hold the panel.

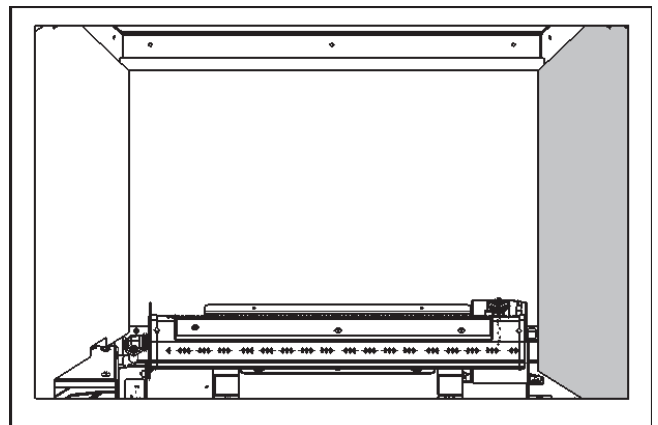

# Installation

## Liners

7. Install the roof panel, supporting it with the rear and side panels.

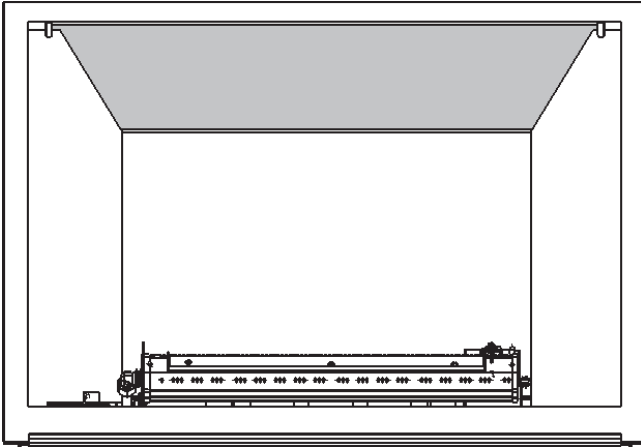

8. Tighten the anchor screws on each side.

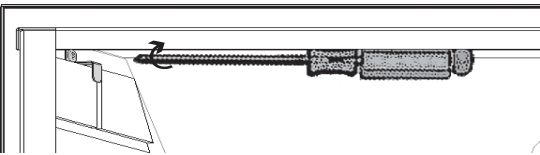

9. Replace the burner cover (2 screws).

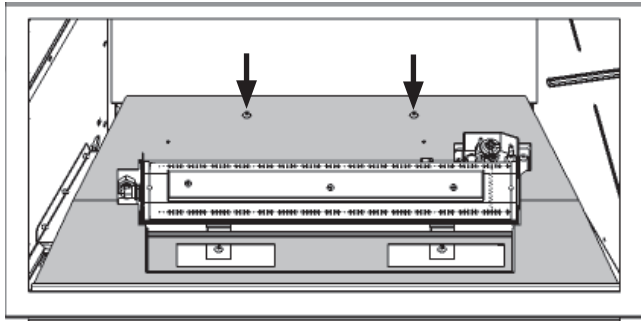

10. Replace the log support (2 screws).

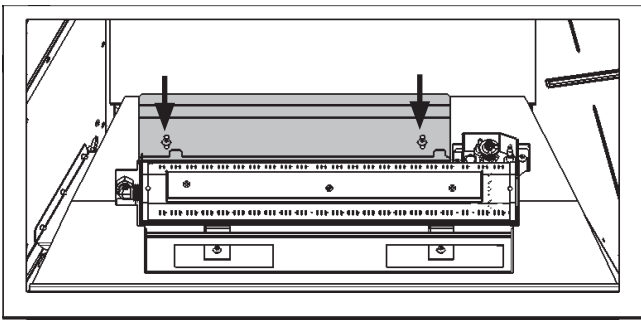

# Installation

## Fuel Beds

### Install Birch Log Kit 700BLK

#### Material required

- Birch Log Kit, which contains:
  - 10 logs
  - 1 bag of embers

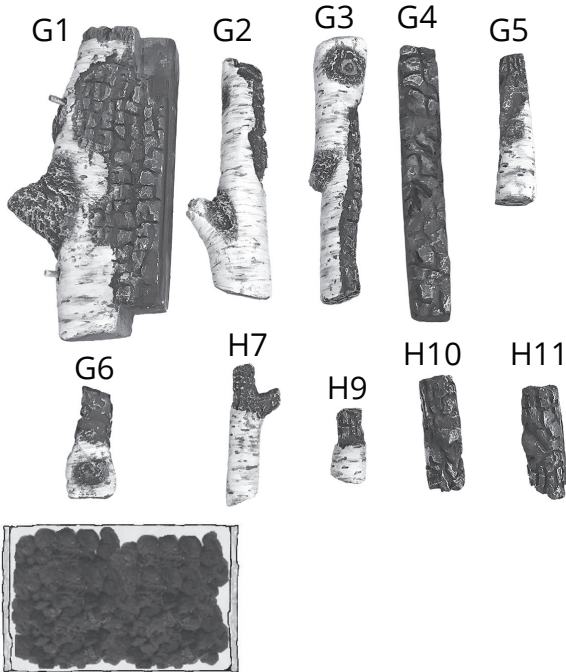

- Gloves, if desired

#### Installation

Carefully unpack the kit. Note each log has its own number stamped on the bottom. Some logs have pegs to help you place them on the burner platform, or other logs.

Install the logs as shown below.

1. Confirm the front edge of the rear log support is flush with the cutout in the burner support platform.

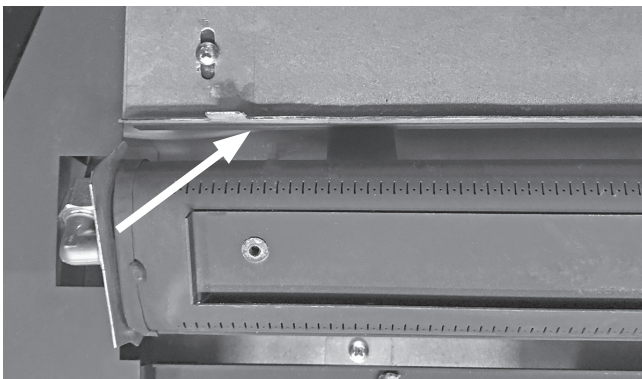

2. Place log G4 directly on the burner, and slide it all the way to the left. There is a groove on the underside of the log that fits on the front rail on the burner.

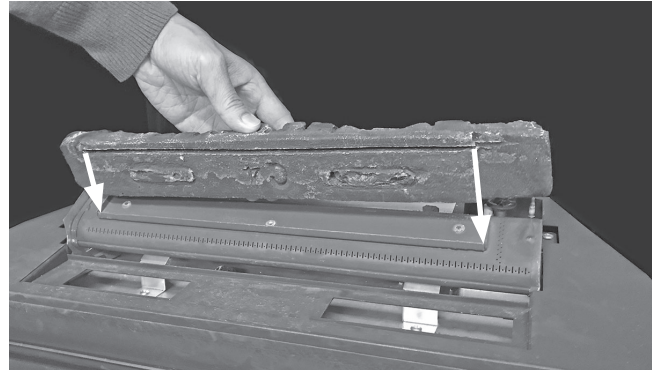

3. Place log H10 in the front left cutout in the burner platform with the long end pointing to the left.



4. Place log H11 in the front right cutout in the burner platform. Orient the H11 with its angled end pointing to the right.





# Installation

## Fuel Beds

5. Place embers in the gap between H10 and H11, and behind H10 and H11, against the burner. Hold some embers back for later steps.



6. Place log G1 on the rear log support as shown, behind the tabs. Slide it to the right until it presses gently against the pilot shield.

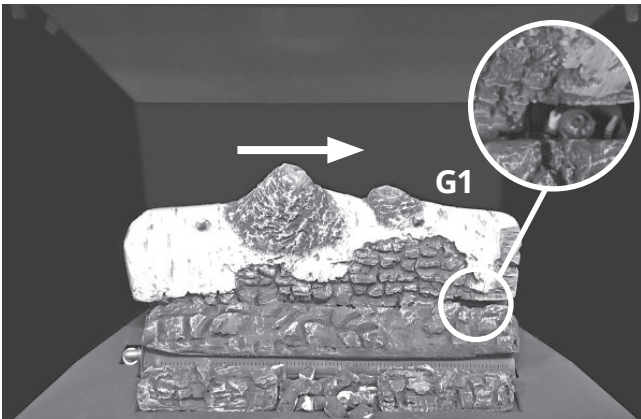

7. Place log G6 as shown, on top of H11 and G4.

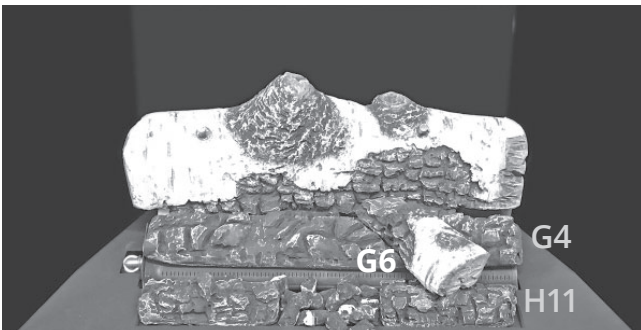

8. Place log G5 as shown, on top of H10 and G6. The bottom of the log rests against a raised knob on H10.

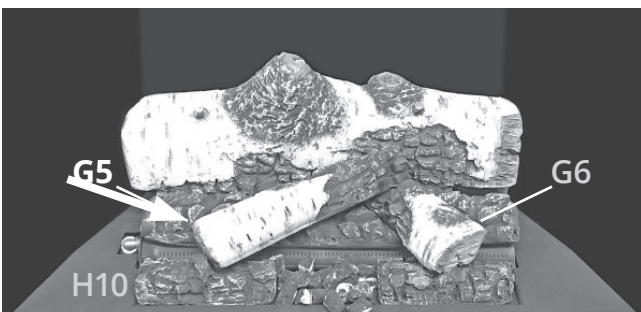

9. Place log H7 as shown, on top of G5 and G4.

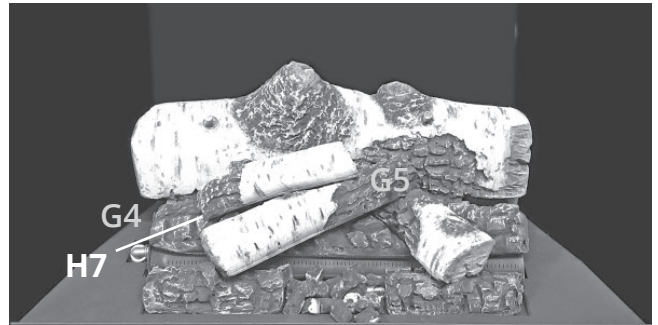

10. Place the hole in log G3 onto the right pin on G1, and rest the other end on the platform.

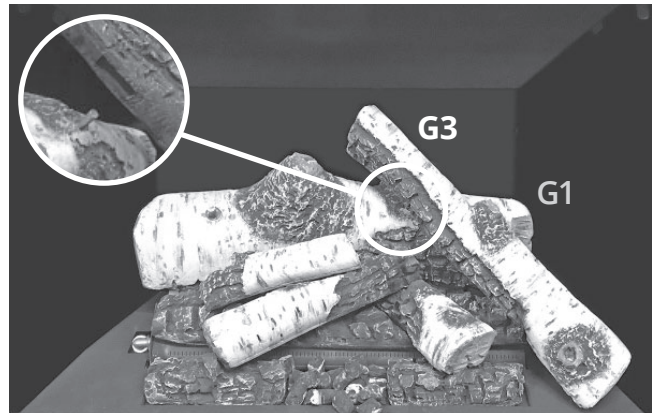

11. Place the hole in log G2 onto the left pin on G1, and rest the other end on the platform.

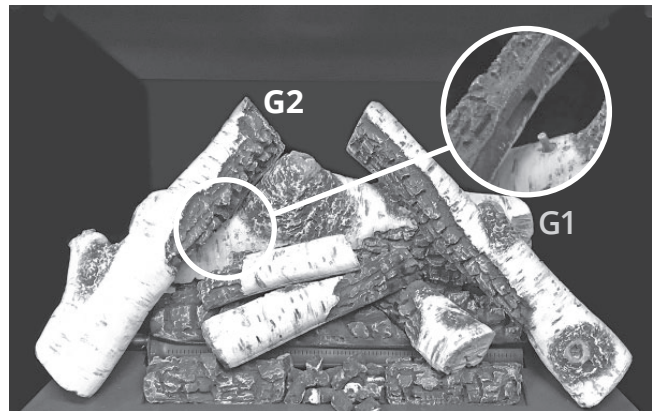

# Installation

## Fuel Beds

- Place log H9 on top of the embers at the front of the fireplace, between H10 and H11.

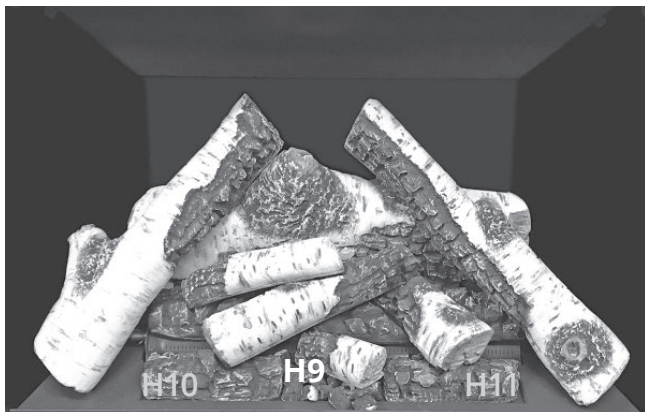

**IMPORTANT:** Approved for use only with the ceramic embers provided with your Valor fireplace. The use of any other products may void your fireplace warranty.

### **WARNING**

**Choking Hazard! Ensure that the fireplace area is clear of embers as these could be ingested by small children. Vacuum area after installation.**

- Place remaining embers as desired along front and sides. You may not need to place all embers.

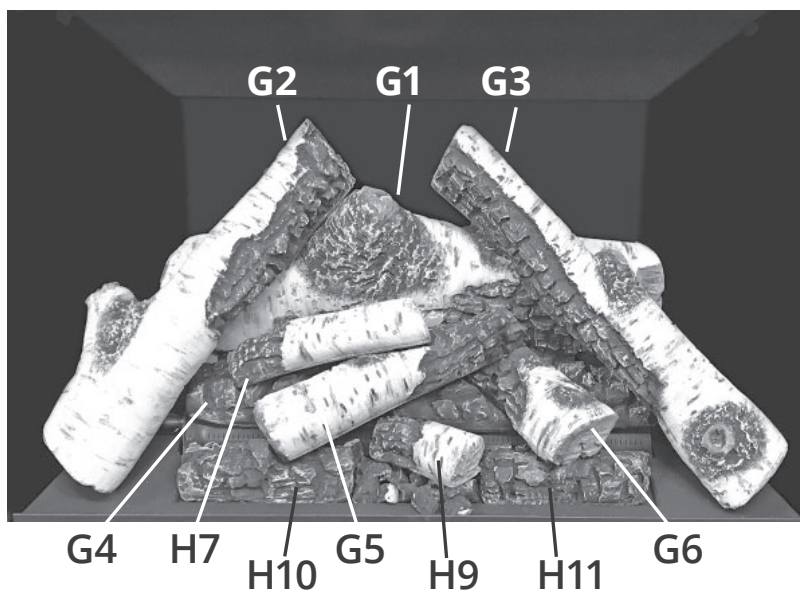

# Installation

## Fuel Beds

### Install Traditional Log Kit 700LSK

#### Material required

- Traditional Log Kit, which contains:
  - 10 logs
  - 1 bag of embers

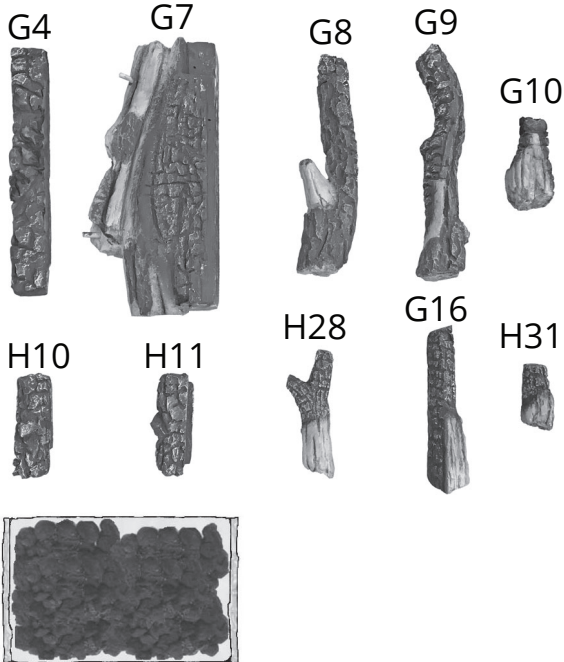

- Gloves, if desired

#### Installation

Carefully unpack the kit. Note each log has its own number stamped on the bottom. Some logs have pegs to help you place them on the burner platform, or other logs.

Install the logs as shown below.

1. Confirm the front edge of the rear log support is flush with the cutout in the burner support platform.

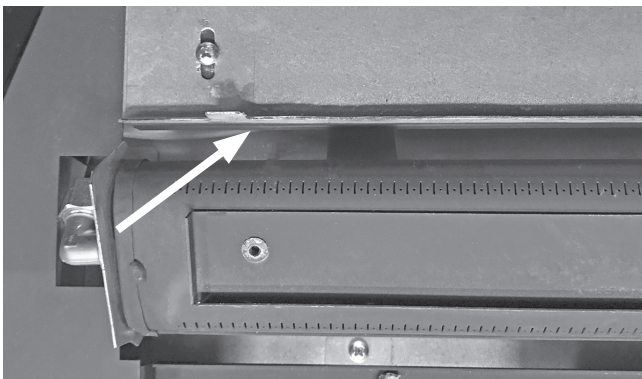

2. Place log G4 directly on the burner, and slide it all the way to the left. There is a groove on the underside of the log that fits on the front rail on the burner.

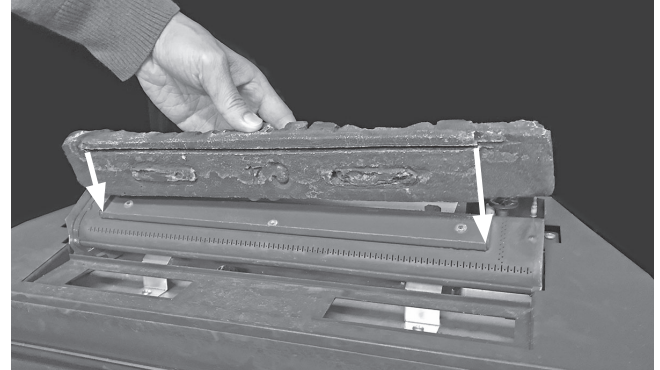

3. Place log H10 in the front left cutout in the burner platform with its long end pointed to the left.

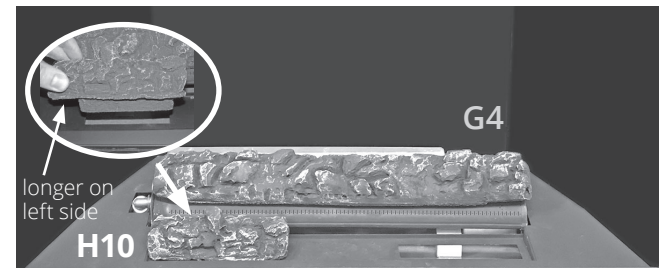

4. Place log H11 in the front right cutout in the burner platform. Orient the H11 with its angled end pointing to the right.

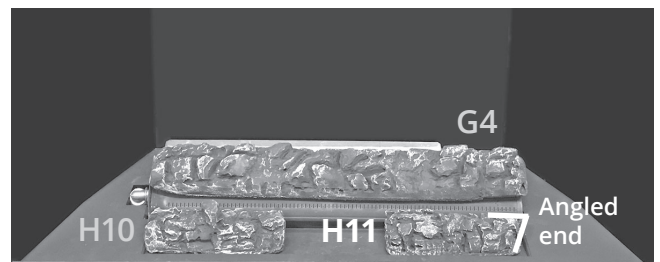



# Installation

## Fuel Beds

5. Place embers in the gap between H10 and H11, and behind H10 and H11, against the burner. Hold some embers back for later steps.

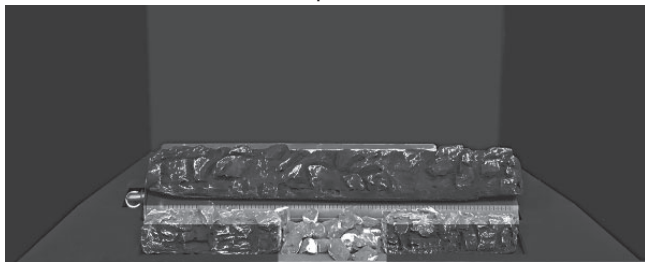

6. Place log G7 on the rear log support as shown, behind the tabs. Slide it to the right until it presses gently against the pilot shield.

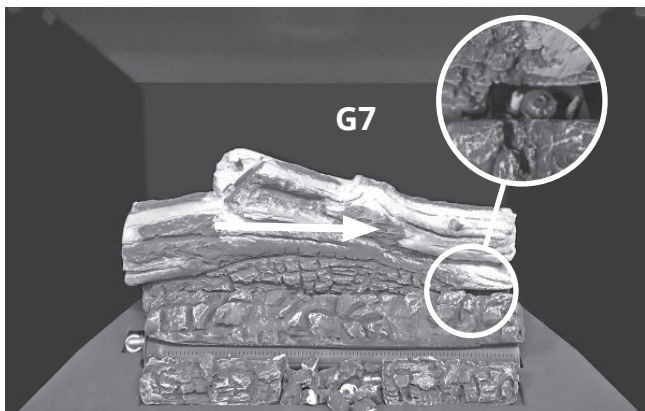

7. Place log G10 on top of G4 and H11.

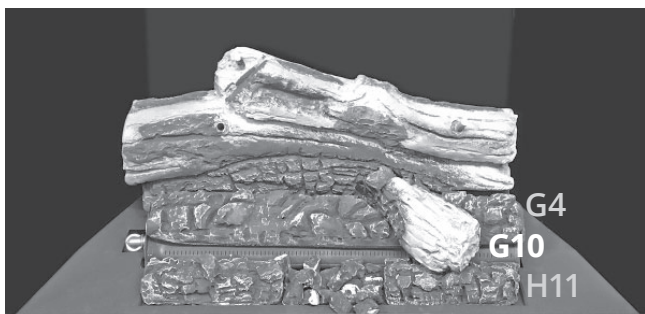

8. Place log G16 on top of H10, and into the groove on top of G10.

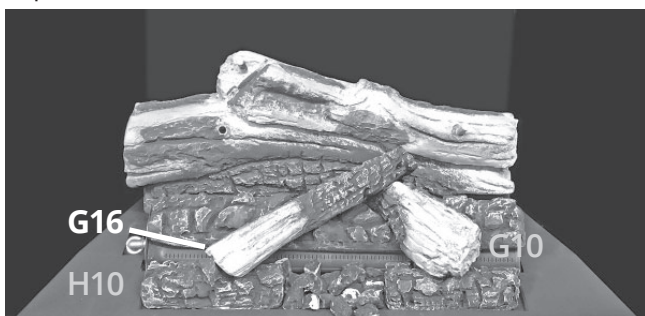

9. Place log H28 on top of G16 and G4.



10. Place log G9 onto the right hand pin on G7 and onto the platform as shown.

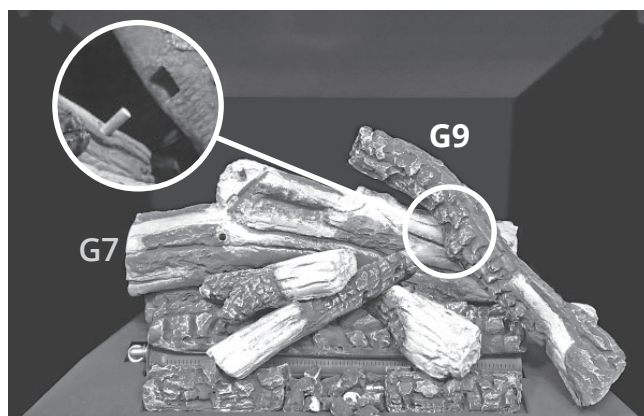

11. Place log G8 onto the left hand pin on G7 and onto the platform as shown.

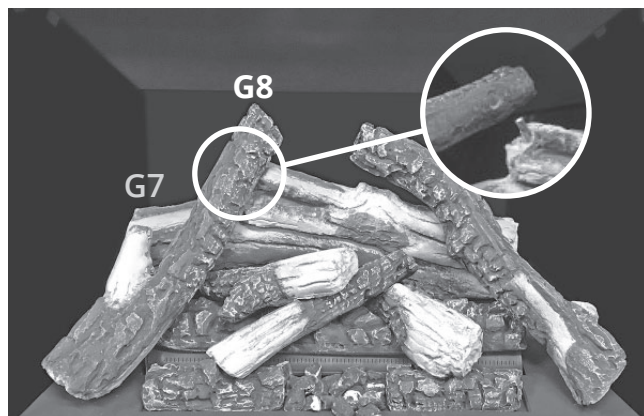



# Installation

## Fuel Beds

12. Place log H31 on top of the embers between H10 and H11.

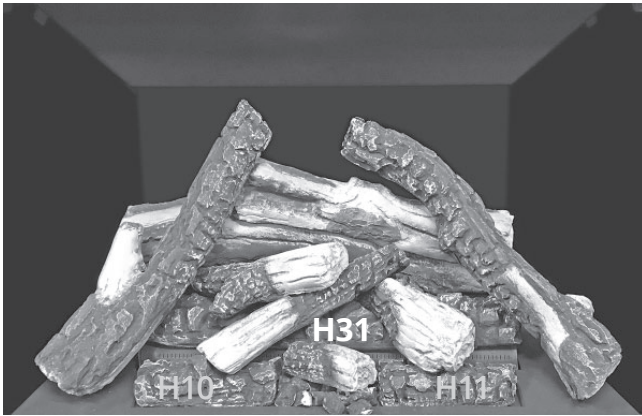

**IMPORTANT:** Approved for use only with the ceramic embers provided with your Valor fireplace. The use of any other products may void your fireplace warranty.

### **WARNING**

**Choking Hazard! Ensure that the fireplace area is clear of embers as these could be ingested by small children. Vacuum area after installation.**

13. Place remaining embers as desired along front and sides. You may not need to place all embers.

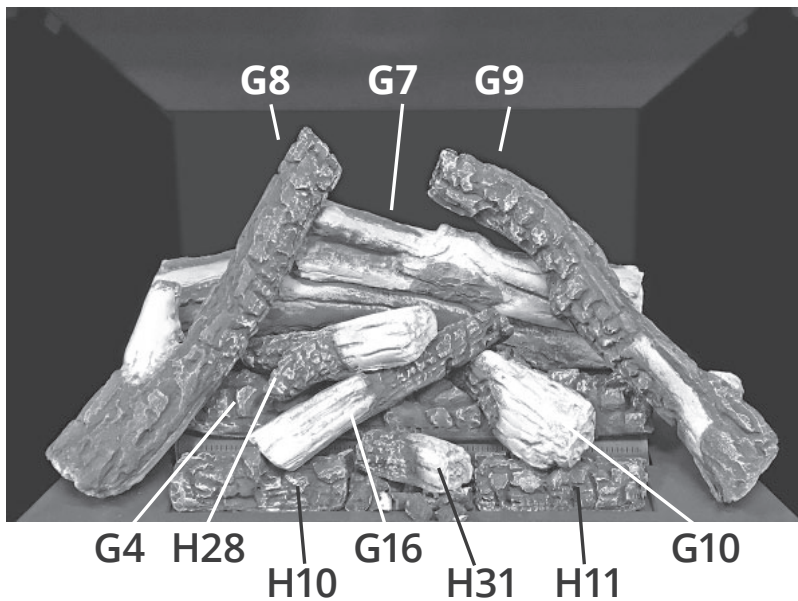

# Installation

## Fuel Beds

### Install Driftwood Log Kit 700DVK

#### Material required

- Traditional Log Kit, which contains:
  - 8 logs
  - 3 pebbles
  - 1 bag of embers
  - A steel cover panel

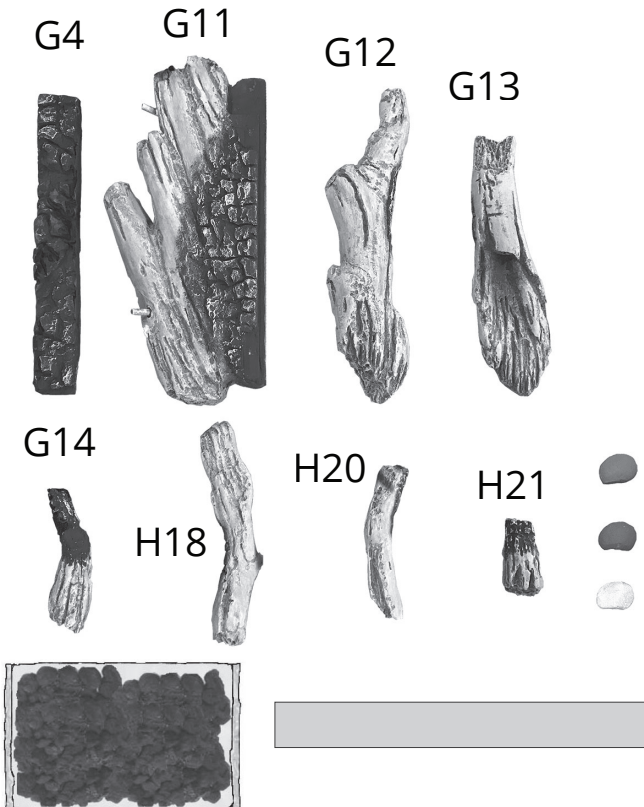

- Gloves, if desired

#### Installation

Carefully unpack the kit. Note each log has its own number stamped on the bottom. Some logs have pegs to help you place them on the burner platform, or other logs.

Install the logs as shown below.

1. Confirm the front edge of the rear log support is flush with the cutout in the burner support platform.

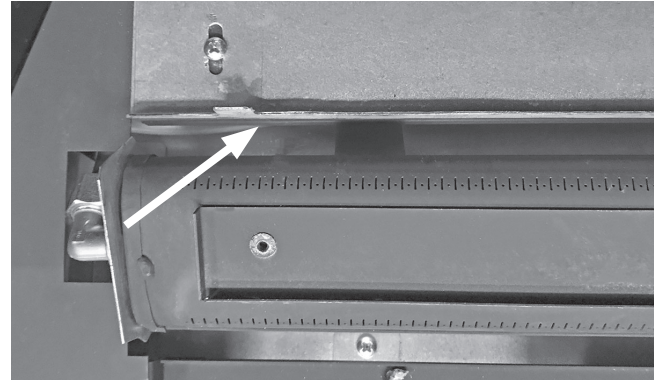

2. Place log G4 directly on the burner, and slide it all the way to the left. There is a groove on the underside of the log that fits on the front rail on the burner.

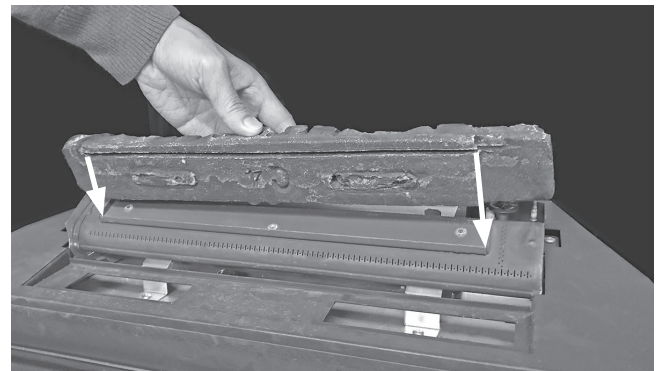

# Installation

## Fuel Beds

- Place log G11 on the rear log support as shown, behind the tabs. Slide it to the right until it presses gently against the pilot shield.

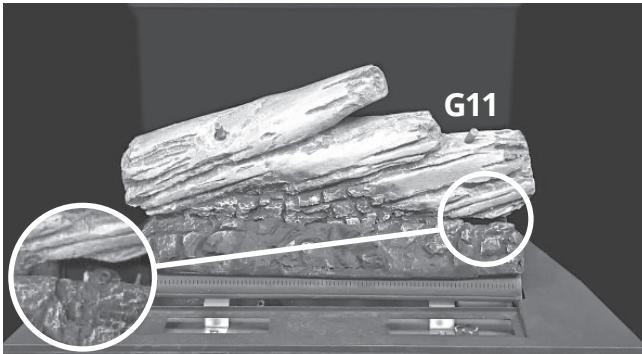

- Place the cover plate that came with the fireplace into the depression in the platform in front of G4.



- Place log G14 on top of G4 and into the platform depression. It should rest against the inside of the front edge of the depression.

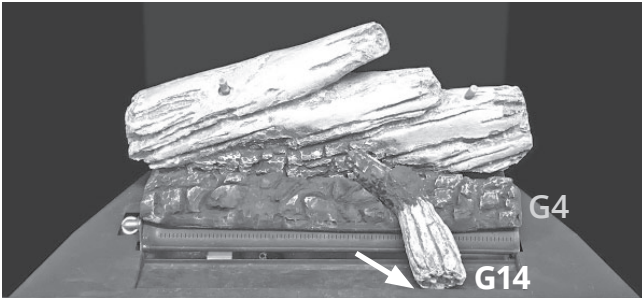

- Place log H18 on top of G14 and into the platform depression. It should rest against the inside of the front edge of the depression.

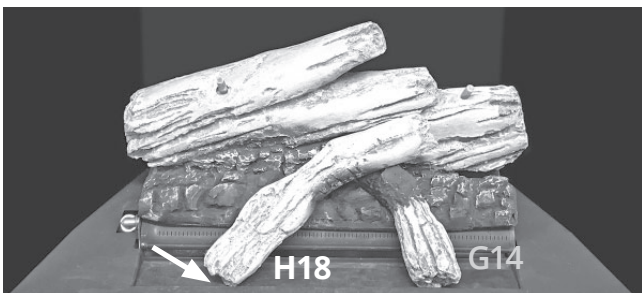

- Place H20 on top of H18 and G4 as shown. H20 rests on top of a knob on G4.



- Place embers in the depression in front of G4, around the base of log H18 and G14.



- Place log G13 onto the right hand pin on G11 and onto the platform as shown.

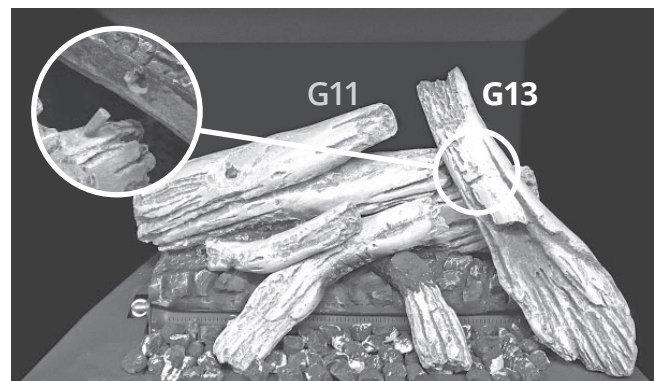



# Installation

## Fuel Beds

10. Place log G12 onto the left hand pin on G11 and onto the platform as shown.



12. Place pebbles to taste around the front of the assembly.



11. Place log H21 on top of the embers between H18 and G14.



**IMPORTANT:** Approved for use only with the ceramic embers provided with your Valor fireplace. The use of any other products may void your fireplace warranty.

### **WARNING**

**Choking Hazard! Ensure that the fireplace area is clear of embers as these could be ingested by small children. Vacuum area after installation.**

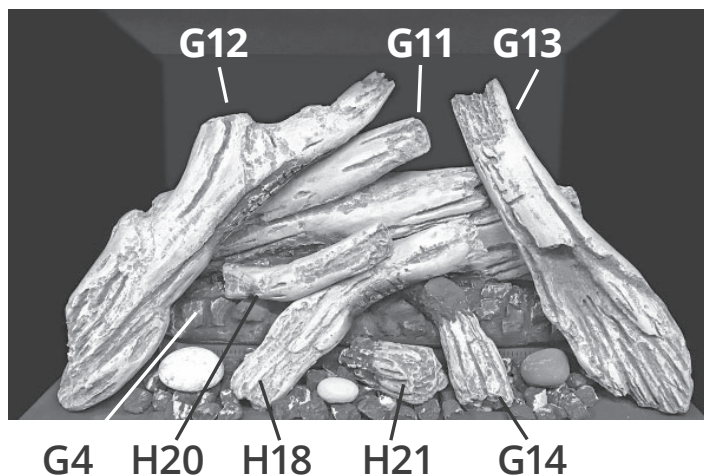

# Installation

## Window Re-Installation & Checking

### Refit and Check Window

1. Place the window in its bottom railing and push its top against the firebox. **Ensure to remove any particles in the railing before installing the window.**

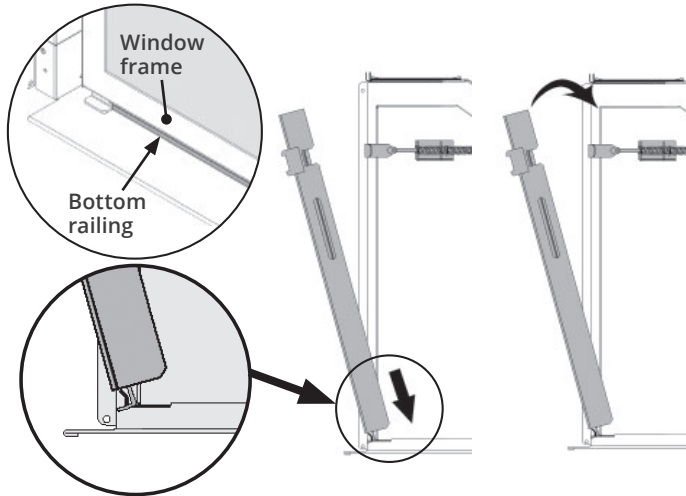

2. While you hold it, hook the side levers into the window tabs.

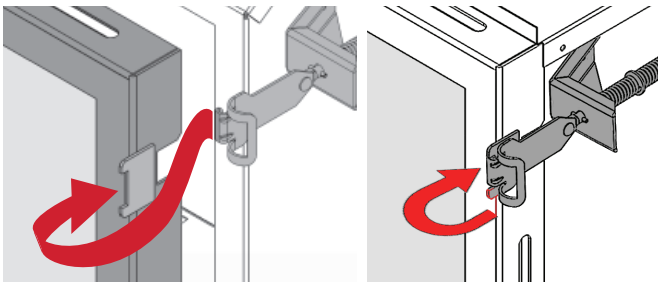

3. Pull out the top of the window and release it to ensure the springs return it.
4. Apply firm hand pressure around the window frame to ensure the window is sealed tight against the firebox.
5. If the Hot Glass Warning plate has been removed from the front lower corner of the window, reinstall it by sliding it between the glass and the frame as indicated below.

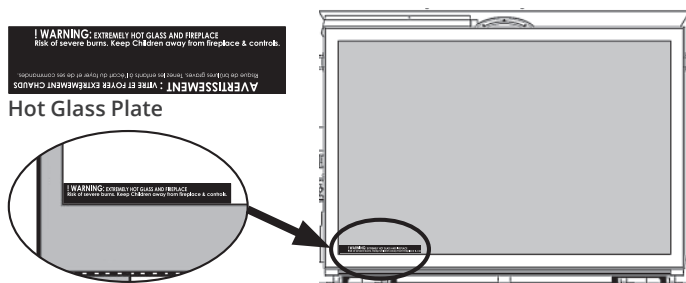

### **⚠️ WARNING**

The window unit must be correctly installed, fastened and sealed after servicing or serious bodily injury and/or damage to the appliance may result.

To ensure a safe operation:

- Double-check that the bottom of the window frame is correctly installed in the bottom support railing;
- Verify that the levers are hooked properly to the window tabs then;
- Pull out the top of the window and release it to insure the springs return it;
- Ensure the window is sealed before operation.

### **⚠️ WARNING**

Failure to install the window correctly can:

- Leak carbon monoxide.
- Affect the performance of the fireplace.
- Damage components.
- Cause overheating resulting in dangerous conditions.

**Damage caused by incorrect window installation is not covered by the Valor Warranty.**

# Installation

## Synchronize Remote Control

The receiver and the handset of the remote control system must be initially synchronized before the first use.

1. Remove the battery holder cover (1 screw).  
Insert 4 x 1.5V alkaline batteries in the holder.



2. On the left hand side of the firebox, pull the loose wire that is already connected to the receiver and connect it to the battery holder.

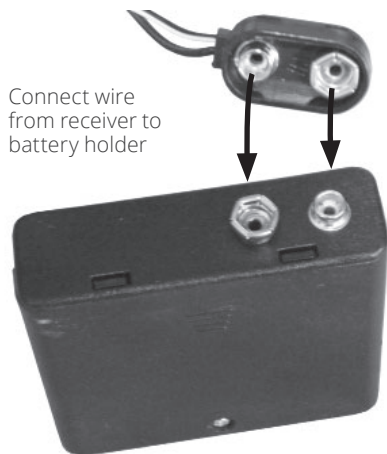
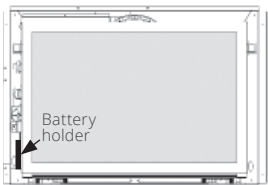

3. Insert 1 9V alkaline battery in the handset.

## Remote Control Pairing

4. With a sharp object, press and hold the receiver's RESET button until you hear one short and one long beep. Release the reset button after the second beep.

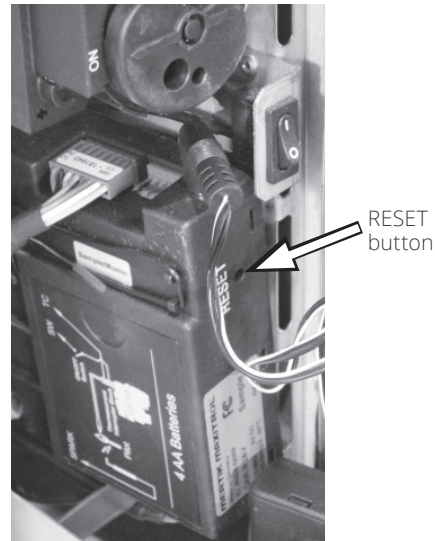

5. Within the subsequent 20 seconds, press the small flame button on the remote handset until you hear two short beeps confirming the synchronization is set.

This is a one time setting only and is not required when changing the batteries in the remote handset. The remote control system is now ready to use.

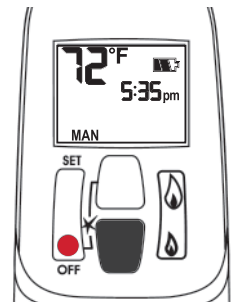

6. Inside the left panel of the appliance outer case, in front of the receiver, peel off the *Velcro* backing and stick the battery box on it to keep it in place.

Battery holder installed

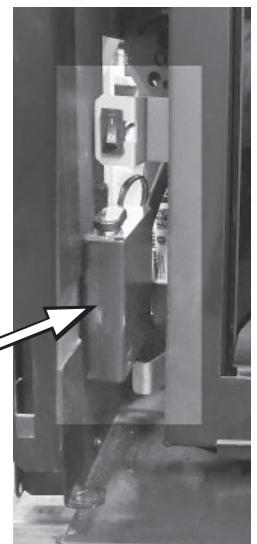

# Installation

## Check Operation

Turn the fireplace flame up and down using the remote control to confirm that the full range of inputs is achieved—see the Remote Control Use starting on page 37.

## Adjust Aeration (if necessary)

Light the fire and allow the unit to warm up for 10–15 minutes to evaluate the flame picture. Burners are equipped with an adjustable shutter to control primary aeration. See the figures below. The shutters are factory-set to an aeration gap which will give optimum performance for the vast majority of installations.

Depending of fuel bed used, altitude and other considerations, the flame picture may be improved by adjusting the aeration. The need for adjustment should be determined only by operating the appliance with the fuel bed, liners and window installed and evaluating the flame picture after a 15-minute warm-up.

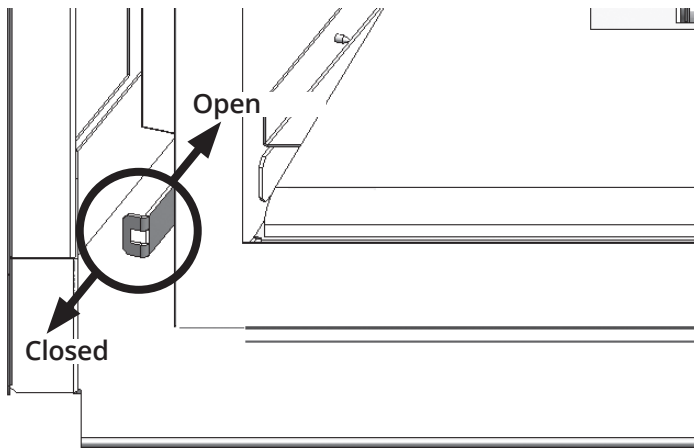

Pull or push the aeration lever at the bottom front left corner of the unit to close or open the air shutter. The shutter is visible at the left hand end of the burner.

## Check Operation and Aeration

Increasing aeration (open) will cause the flames to appear more transparent and blue showing more ceramic effects glow.

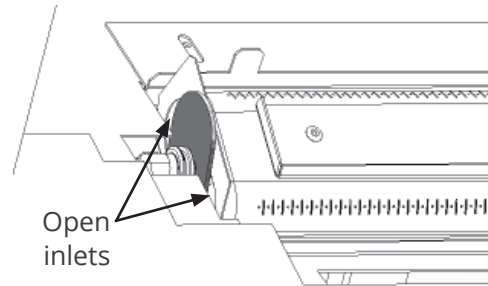

Decreasing aeration (close) will cause the flames to appear more yellow or orange showing less ceramic effects glow.

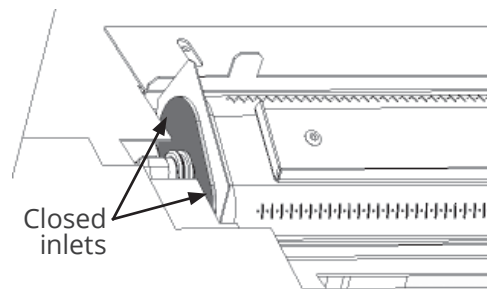

***Too little aeration may result in black carbon forming and dropping into the firebox.***

# Installation

## Front Trim

### Install Side Shrouds

The side shrouds are required to install the front on the appliance. They are supplied with the engine.

Fit them to the appliance outer case as indicated (2 screws/side).

See instructions supplied with the front trim for installation of trim.

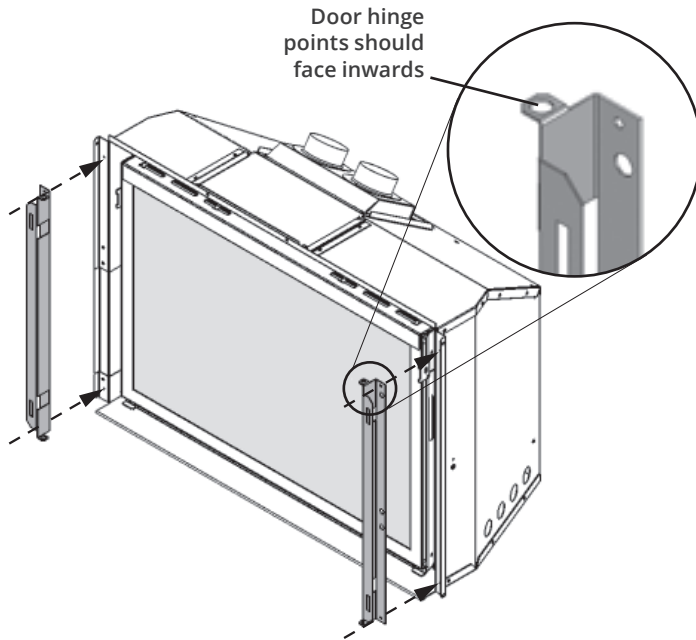

### Install Front, Trim and Barrier Screen

Install the front or trim chosen by the customer for their fireplace. Install as well the barrier screen which is provided with the front or trim.

Show the customer how to access the controls when the front or trim are installed and how to remove them.

Follow the instructions provided with the front or trim and leave those instructions behind for the customer's further reference.



# Installation

## Remote Control Holder

### Install Remote Control Handset Wall Holder

The remote control kit for this fireplace comes complete with a wall-mounted holder. This holder is not required in all installations but is provided as an optional feature for those customers who wish to mount the remote handset to the wall.

To install the holder to the wall, find a convenient location and use the hardware provided with the kit.

**IMPORTANT:** The location of the remote control handset is important to assure proper temperature regulation.

To obtain a constant temperature, we recommend that the handset should be **between 3 and 15 feet away from the appliance but not directly above it**. We also advise that the handset should be located away from any other heat source and not in direct sunlight as this may affect the temperature sensor located in the remote handset.

#### Contents

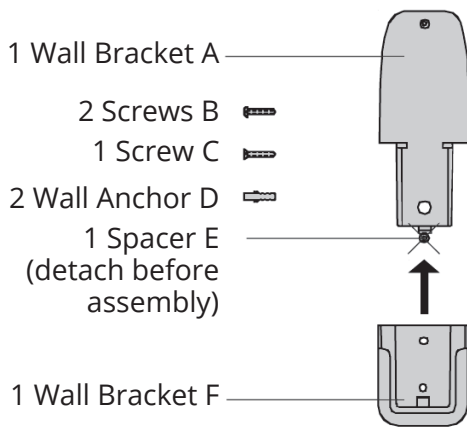

#### Alternative 1

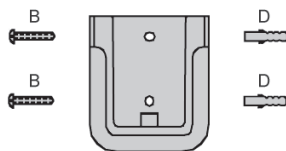

#### Alternative 2

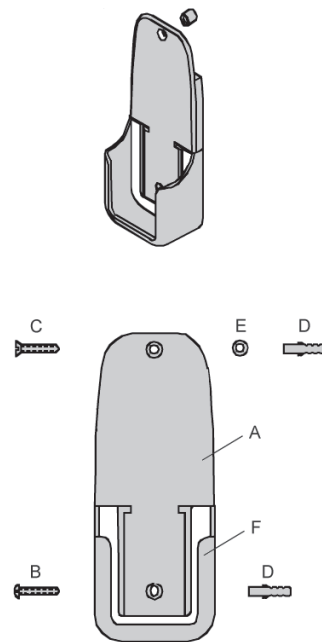

#### Alternative 3

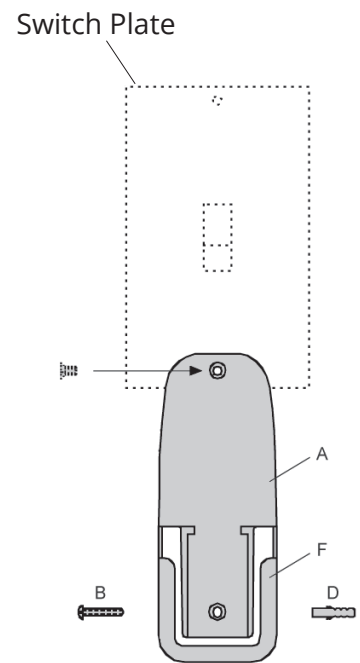

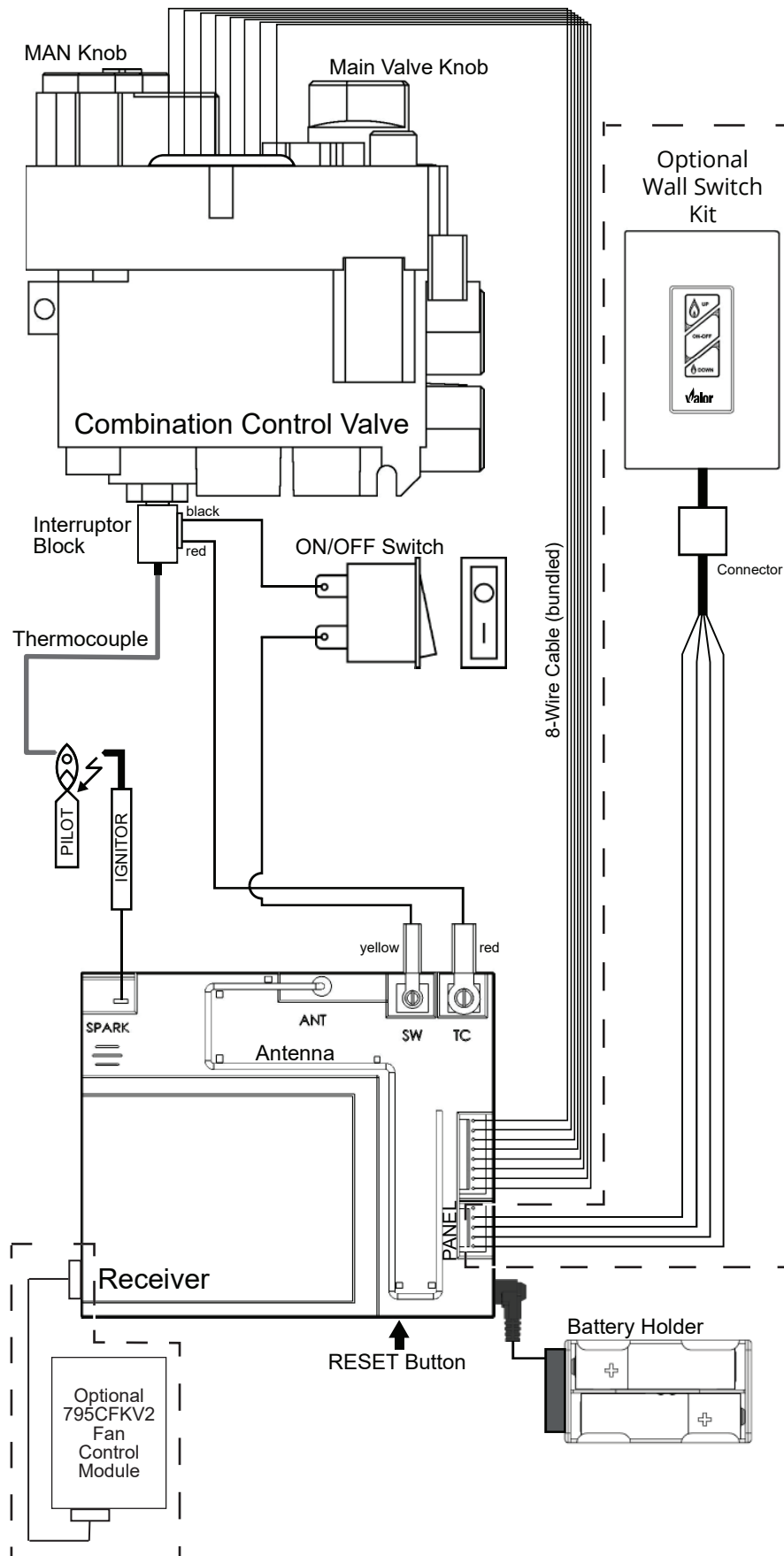

# Installation

## GV60 Wiring Diagram



# Approved Venting Components

Approved Direct Vent Suppliers for Valor Models 700 <sup>4</sup> , 739 <sup>3</sup> , 780 <sup>4</sup> and 785										
  Venting Parts Description		Venting Parts Code / availability by Manufacturer								
		DURA-VENT	SELKIRK	ICC EXCEL DIRECT	SECURE VENT	RLH INDUSTRIES	AMERIVENT	MILES INDUSTRIES	BDM	
Termination Caps	Vertical	Standard Co-axial	46DVA-VC	4DT-VT	—	—	HSDV4658-1313	4DVC	—	940264
								4DH-1313		940364
										940206LP
		High Wind Co-axial	46DVA-VCH	—	TM-4SVT	SV4CGV	—	—	—	—
		Extended Co-axial	46DVA-VCE	—	—	—	—	—	—	—
	Vertical	Co-linear	46DVA-CL33 46DVA-CL33H 46DVA-CL33P	—	TM-IVT	3PDVCV	HS-C33U-99	HCL-99-33	559CLT	940033B
							HCL-913-33	940034B		
HS-C33F-1313							HCL-1313-33	940033HWS		
								940033RD		
Horizontal		—	—	—	—	—	720SWK <sup>3</sup> 720SWK-M <sup>3</sup> 720SWK-M2 <sup>4</sup>	—		
Vent Adapters / Couplers	Universal Adapter 3" Flex Coupler		2150	—	TM-CFAA3	—	—	—	95090390	
	Co-linear Flex Connector		46DVA-ADF	—	—	—	—	—	—	
	Co-linear-to-Co-axial Adapter		46DVA-GK 46DVA-CLTA	—	TM-4CTA	—	—	4DCAT33	—	
Aluminum Flexible Liner	3" or 4" diameter		NOTE: 2-ply liner approved to CAN/ULC S635 suitable for venting gas appliances. As manufactured by Z-Flex, Flexmaster and others.							
			2280 Series	AF3-35L	TM-ALK33 TM-ALT33	—	—	—	—	952703 952704
Flashings	Roof Flashing 0/12-6/12		46DVA-F6	4DT-AF6	TF-4FA	SV4FA	—	4DF (0/12-5/12)	—	949606012
	Roof Flashing 7/12-12/12		46DVA-F12	4DT-AF12	TF-4FB	SV4B	—	4DF12 (6/12-12/12)	—	949606712
	Flat Roof Flashing		46DVA-FF	—	TF-4F	SV4F	—	—	—	949606001
	Masonry Flashing		—	—	TF-4MF	—	—	—	559FSK	

- Notes:**
1. Follow instructions supplied with each manufacturer's components.
  2. Termination caps manufactured by RLH Industries or American Metal Products are from Homestyle Chimney Collection and can be ordered in one of the following finishes: a) aluminum; b) black powder coated; c) solid copper.
  3. The 720SWK-M Sidewall Kit can only be installed on the 739M and 739V models; the 720SWK can be installed on the 739-72 models.
  4. The 720SWK-M2 Sidewall Kit can only be installed on the 700M and 780M models.

# Appendix A—Lighting Instructions

## FOR YOUR SAFETY, READ BEFORE LIGHTING

**WARNING:** If you do not follow these instructions exactly a fire or explosion may result causing property damage, personal injury or loss of life.

- A. This appliance has a pilot which must be lighted by hand or by remote control. Follow these instructions exactly. To save gas, turn the pilot off when not using the appliance for a prolonged period of time.
- B. **BEFORE LIGHTING**, smell all around the appliance area for gas. Be sure to smell next to the floor because some gas are heavier than air and will settle on the floor.
- WHAT TO DO IF YOU SMELL GAS**
- Do not try to light any appliance.
  - Do not touch any electric switch; do not use any phone in your building.
  - Immediately call your gas supplier from a neighbor's phone. Follow the gas supplier's instructions.
  - If you cannot reach your gas supplier, call the fire department.
- C. Use only your hand to push in or turn the control knobs. Never use tools. If the knobs will not push in or turn by hand, don't try to repair them; call a qualified service technician. Force or attempted repair may result in a fire or explosion.
- D. Do not use this appliance if any part has been under water. Immediately call a qualified service technician to inspect the appliance and to replace any part of the control system and any gas control, which has been under water.

## LIGHTING INSTRUCTIONS

Dependent on model, switch #1 may be mounted directly to valve see Fig 2A.

Fig 1

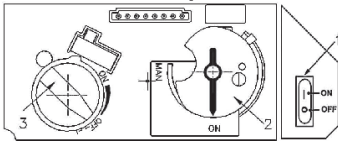

Fig 1A

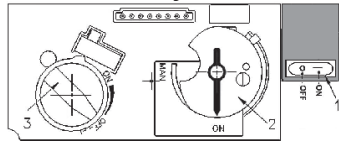

Fig 2

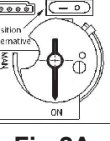
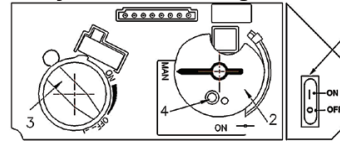



Fig 2A

1. **STOP!** Read the safety information above.
  2. **SET ON/OFF SWITCH (1) TO "OFF" POSITION.**
    - Wait five (5) minutes to clear out any gas, then smell for gas, including near the floor. If you smell gas, **STOP!** Follow "B" in the safety information above on this label. If you don't smell gas, go to the next step.
  3. **AUTOMATIC IGNITION (fig. 1):** Locate the pilot (fig 3.) inside of firebox.
    - ON/OFF switch (1) in ON position, MAN-knob (2) in ON position; set Flame Adjustment knob (3) to lowest setting (∩)
    - On the remote control handset, press and hold the 'off' button and  (large flame) simultaneously; a short acoustic signal confirms the start has begun;
    - Further short acoustic signals indicate the ignition process is in progress;
    - When the pilot is lit, the Flame Adjustment knob (3) will automatically rotate to the highest setting.
    - Press the small flame on the remote control handset to reduce the flame height.
  4. **MANUAL IGNITION (fig. 2):** With the window off, locate pilot (fig. 3) inside firebox;
    - ON/OFF switch (1) in ON position, MAN-knob (2) in MAN position;
    - Set Flame Adjustment knob (3) to the lowest setting (∩);
    - Push down the metallic core (4) with a pen or similar instrument; this will establish the pilot gas flow;
    - Light gas at the pilot (5) with a match;
    - Continue holding down metal core (4) for about 10 seconds; after release, pilot should remain lit;
    - If the pilot will not stay lit after several tries, turn the gas control knob (3) to "OFF" (∩) and call your local service technician or gas supplier.
- Reinstall the window and set the MAN-knob (2) to "ON"; turn Flame Adjustment knob (3) up (∪) or down manually or use the up/down 'flame' buttons on the remote control handset to adjust the flame height.

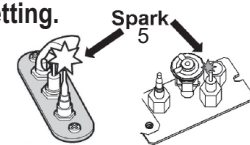

Fig 3

## TO TURN OFF GAS TO APPLIANCE

**AUTOMATIC SHUT-OFF (using the remote control handset):**

1.
  - Press and hold the small flame on the remote control handset to shut-off the main burner gas flow;
  - Press "OFF" button (red dot) on remote handset to shut-off the appliance, including pilot flame.

# Appendix B—Remote Control Operation

## Initial Pairing

Before the remote control can be used with the fireplace, it must be paired. See page 30.

## Radio Frequency

315 MHz for USA and Canada.

This device complies with Part 15 of the FCC Rules and with Industry Canada license-exempt RSS standard(s). Operation is subject to the following two conditions:

(1) this device may not cause harmful interference, and

(2) this device must accept any interference received, including interference that may cause undesired operation.

**NOTE: Before using the remote control system for the first time**, the receiver and the handset must be synchronized. See the section *Synchronize Remote Control*.

**IMPORTANT: BEFORE YOU BEGIN**, please note that on this system, the settings of time, temperature and automatic ON/OFF **can only be programmed when the function display is flashing**. Be patient when programming as it can take a few seconds to set.

Note: In the TEMP or TIMER modes, the remote handset senses the room temperature and adjusts the flame accordingly.

To communicate, the handset should be within 15 feet (4.5 meters) of the fireplace.

**Do not leave the handset on the mantel or hearth.**

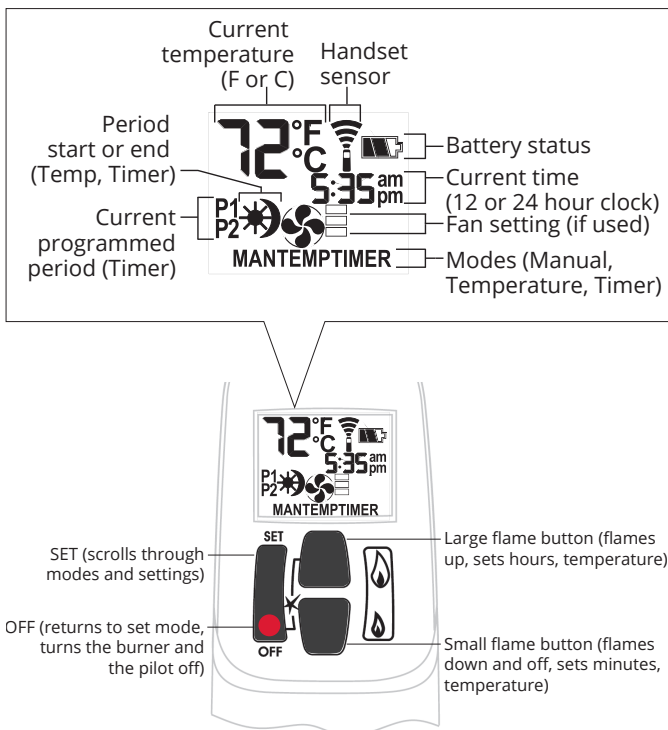

## Turn Fireplace ON

Press ● + 🔥 buttons until you hear a short beep; release buttons.

Beeps continue until pilot is lit.

Burner lits to maximum flame height and handset goes automatically to manual (MAN) mode.

NOTES:

On the valve, MAN button must be at ON, in full counter-clockwise position .

ON/OFF switch (if equipped) must be in I (ON) position.

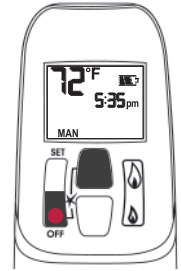

## Turn Fireplace OFF

Press ● button.

When pilot is just turned off, wait 2 minutes to light it again.

## Standby Mode (Pilot Flame)

Press and hold 🔥 to set fireplace to pilot.

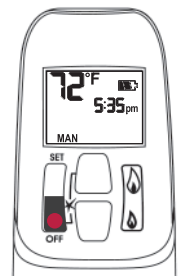

## Adjust Flames Height

With pilot lit, press and hold buttons:

🔥 = increase flame height

🔥 = decrease flame height or set to pilot

For fine adjustment, tap buttons.

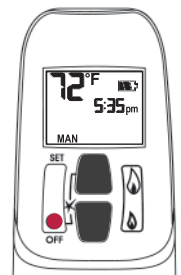

## Express Low and High Fire

Double-click buttons:

🔥 = increase flame to maximum height "HI"

🔥 = decrease flame minimum height "LO"

NOTE: Flame goes to high fire first before going to designated low fire.

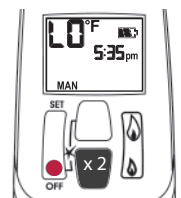
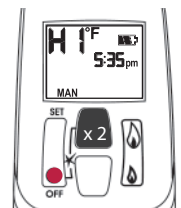

# Appendix B—Remote Control Operation

## Setting °C/24-hr or °F/12-hr clock

In MAN mode, press ● + 🔥 buttons until temperature / clock display changes from

°F / 12-hour ↔ °C / 24-hour

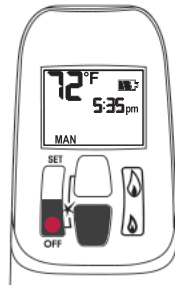

## Setting Time

The time display will flash after either:

- installing the battery, or
- pressing 🔥 + 🔥

To set the time, press buttons:

🔥 = hour

🔥 = minutes

Press ● or wait to go back to MAN.

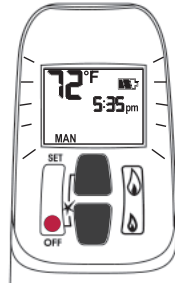

## Modes of Operation

Briefly press SET cycles through modes of operation.

MAN > ⚙️ TEMP > 💡 > 🌀 >

🌙 TEMP > ⌚ TIMER > MAN

NOTE: Press 🔥 or 🔥 to reach MAN mode.

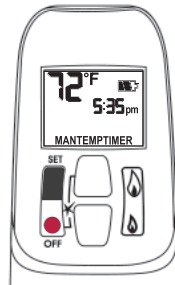

## MAN Manual Mode

Manual flame height adjustment.



## ⚙️ TEMP Daytime Temperature Mode

When pilot is lit, room temperature is measured and compared to set temperature. Flame height automatically adjust to reach Daytime Set Temperature.



## 💡 Light/Dimmer Mode

Not available on this fireplace.



## 🌀 Fan Mode

Turns fan ON and OFF and adjusts speed.



Note: To turn fan OFF, press 🔥 until all 4 bars disappear.

## 🌙 TEMP Night time Setback Temperature Mode

When pilot is lit, room temperature is measured and compared to set temperature. Flame height automatically adjust to reach Night Time Setback Temperature.

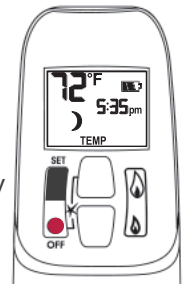

## ⌚ TIMER Timer Mode

When pilot is lit, two periods of time (P1 and P2) can be programmed to use Daytime and Night time temperatures at specific times.

Note: Display shows set temperature every 30 seconds.



Set the different parameters when they are flashing.

# Appendix B—Remote Control Operation

## Circulating Fan Operation (if equipped)

Circulating fan has 4 speed levels from low to high (1 to 4 bars).

Press SET to scroll to . Fan and level icons flash.

To set speed, press flame buttons:

= increases speed.

= decreases speed and turns OFF fan when all bars disappear.

Note: 8 seconds after the fan is set, handset goes automatically in temperature control mode. Fan starts 4 minutes after gas opens (from OFF or pilot) at maximum speed then goes to displayed level after 10 seconds. Fan stops 10 minutes after gas is OFF or at pilot.

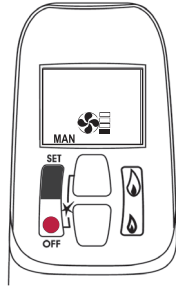

## Setting Program Timers

You can program two periods of time between 12 am and 11:50 pm in each 24-hour cycle.

Programs P1 and P2 must be set in the following order during a 24-hour cycle: **P1** , **P1** , **P2** and **P2** .

= Day Time temperature (high) program period

= Night Time temperature (low) program period

### Default Settings:

Program 1: **P1** 06:00 am **P1** 08:00 am

Program 2: **P2** 11:50 pm **P2** 11:50 pm

Press SET to scroll to **TIMER** .



If **P1** = **P1** or **P2** = **P2** , programming is cancelled.

To keep fireplace ON all night, set **P2** at 11:50 am and **P1** at 12:00 am.

If you want to program only one period, program **P1** and **P1** with desired times then **P2** and **P2** with the same time as **P1** .

## Setting high / low Temperatures

### Setting "DAYTIME" high temperature.

Default Settings: **TEMP** 23 °C/74 °F

Press SET to scroll to **TEMP**

Hold SET button until TEMP flashes.

To set Daytime Temperature:

= increases temperature.

= decreases temperature.

Press or wait to complete setting.

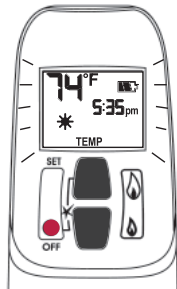

### Setting P1 time - high temperature.

Hold SET button until **P1** is displayed and time flashes.

To set time:

= hour

= minutes

Press or wait to complete setting.

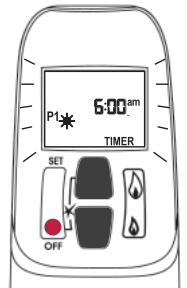

### Setting "NIGHT TIME SETBACK" low temperature.

Default Settings: **TEMP** "--" (OFF)

Press SET to scroll to **TEMP**

Hold SET button until TEMP flashes.

To set Night Time Temperature:

= increases temperature.

= decreases temperature.

Press or wait to complete setting.

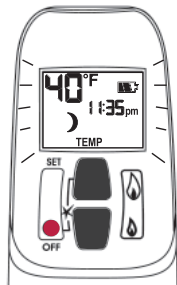

### Setting P1 time - low temperature.

Hold SET button until **P1** is displayed and time flashes.

To set time:

= hour

= minutes

Press or wait to complete setting.



# Appendix B—Remote Control Operation

Setting P2 high and low temperature times.

Repeat same steps as Setting P1.

When all settings are complete, press ● to save them.

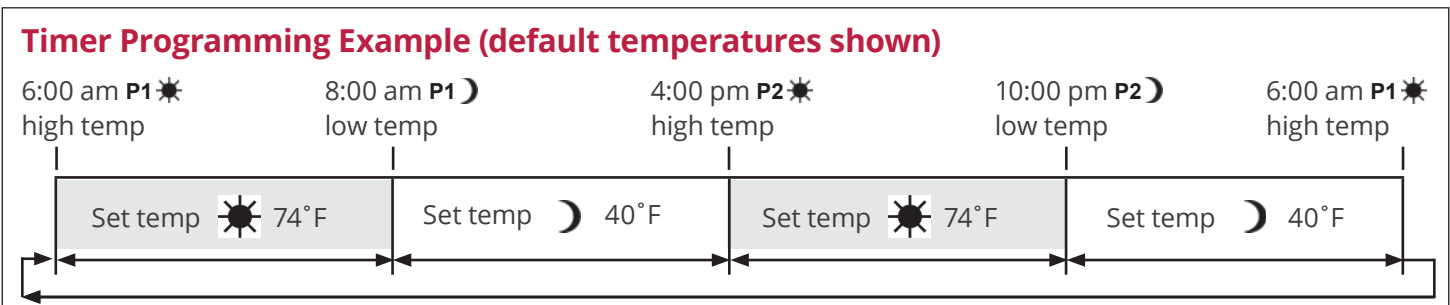

## Automatic Turn Down

### 8 Hour no Motor Movement

The valve will turn to pilot flame if there is no motor movement for an 8-hour period.

## Automatic Shut-Off

**Low Batteries Receiver.** With low battery power in the battery holder the system shuts off the fire completely. This does not apply when the power supply is interrupted.

**On-Demand Pilot (7 Day Shut-Off).** This green feature eliminates gas energy consumption during extended appliance inactivity. When the appliance is inactive for an extended period of time the system automatically extinguishes the pilot. This feature helps the consumer realize cost benefits by automatically eliminating energy consumption during non-heating months and limited use.

The programmed length of inactivity to activate the system is specified by the appliance manufacturer and cannot be altered in the field.

## Low Battery Indication

**Handset:** The battery icon  will show when the battery needs to be replaced. Replace with one 9 V **alkaline**

### Caution

DO NOT USE a screwdriver or other metallic object to remove batteries from holder. This could cause a short-circuit.

battery.

**Battery holder:** Frequent 'beeps' for 3 seconds when the valve motor turns indicate the batteries need to be replaced in battery holder. Replace with four 1.5 V **alkaline** batteries.

## Handset / Receiver Match

The remote control handset and receiver are programmed to function together. In case of a replacement of the handset or the receiver, you will need to reset the receiver to allow them to function together. Contact your dealer for details.



# Appendix C—Spare Parts

	Description	Part No.
1	VDRT slider assembly	4006540
2	Exhaust plate gasket	4001662
3	Shroud (2)	4003295
4	Burner cover platform	4007921
5	Log support bracket	4008289
6	Side cover	4002806
7	Valve access plate	4002510
8	Access plate gasket	4002664
9	Window assembly	4004409
10	Explosion lever assembly (right hand)	4003680
11	Explosion level assembly (left hand)	4003681
12	Hot glass warning plate	4003093
13	Battery holder cable (1500 mm)	4006552
14	Battery holder	4008039
15	Handset GV60 MAX	4002251
16	Handset wall holder	9000008
17	GV60 valve repair kit (not included)	4004544
18	Burner module assembly (natural gas)	4007922
	Burner module assembly (propane gas)	4007923
19	Pilot shield	4008555AH
20	Pilot assembly (natural gas)	4006019
	Pilot assembly (propane gas)	4006020
21	Plug pilot	4000726
22	Pilot assy injector #51 (natural gas)	4000727
	Pilot assy injector #30 (propane gas)	4000728
23	Thermocouple	4004801
24	Pilot injector #51 (natural gas)	4000735
	Pilot injector #30 (propane gas)	4000736
25	Pilot tube	4005046
26	Pilot hood 2-flame	4000730
27	Burner	4007354
28	Pilot bracket	4007142
29	Platform stand	4007799
30	Burner mount (2)	4007140
31	Platform fixing bracket	4008079
32	Flex pipe assembly with valve	4002475
33	Anti-flashback shield	4007629

	Description	Part No.
34	Air shutter (Natural gas)	4007136
	Air shutter (Propane)	4008699
35	Spring tension washer	4007460
36	Steel flat washer	4007461
37	Injector elbow #750 (natural gas)	4000738
	Injector elbow 92-260 (propane)	9730007
38	Gas supply tube assembly	4007875
39	Thermocouple interruptor block	4001037
40	GV60 valve assembly (natural gas)	4008333S
	GV60 valve assembly (propane gas)	4003163S
41	Module side plate top gasket	4003238
42	Module side plate side gasket (2)	4002404
43	Module side plate bottom gasket	4003237
44	Receiver (MAX version)	4002422
45	Single pipe sealing plate	4003236
46	Thermocouple pilot sealing plate	4007887
47	Wiring harness GV60	4001187
48	Ignition cable	4001039
49	Ignition cable sleeve (530 mm)	4002244
50	Interruptor cable (red)	4001035
51	Switch with cable	4001036
52	Birch Log Kit	700BLK
	Birch Log G1	4008159
	Birch Log G2	4008160
	Birch Log G3	4008161
	Birch Log G4	4008162
	Birch Log G5	4008163
	Birch Log G6	4008164
	Birch Log H7	4007469
	Birch Log H9	4007471
	Birch Log H10	4007472
	Birch Log H11	4007473
53	Embers (2 cup bag)	4008304

# Appendix C—Spare Parts

	Description	Part No.
54	Driftwood Log Kit	700DWK
	Driftwood Log G11	4008169
	Driftwood Log G12	4008170
	Driftwood Log G13	4008171
	Driftwood Log G4	4008162
	Driftwood Log G14	4008172
	Driftwood Log H18	4007497
	Driftwood Log H20	4007499
	Driftwood Log H21	4007500
	Driftwood Pebbles (set of 3)	4008173
55	Embers (2 cup bag)	4008304
56	Cover panel	4007895
57	Traditional Log Kit	700LSK
	Traditional Log G4	4008162
	Traditional Log G7	4008165
	Traditional Log G8	4008166
	Traditional Log G9	4008167
	Traditional Log G10	4008168
	Traditional Log G16	4008306
	Traditional Log H10	4007472
	Traditional Log H11	4007473
	Traditional Log H28	4007505
	Traditional Log H31	4007508
58	Embers (2 cup bag)	4008304
59	Liner panels - complete set	

	Description	Part No.
	Fluted Black Liner Kit	707FBL
	Ledgestone Liner Kit	705LSLV3
	Valor Red Liner Kit	708VRL
60	Left hand side panel	
	Fluted Black	4003208
	Ledgestone	4008184
	Valor Red	4003217
61	Right hand side panel	
	Fluted Black	4003209
	Ledgestone	4008185
	Valor Red	4003218
62	Rear panel	
	Fluted Black	4003210
	Ledgestone	4008183
	Valor Red	4003219
63	Top panel	
	Fluted Black	4003202
	Ledgestone	4008182
	Valor Red	4003220
64	Reflective Glass panels - complete set	706RGL
65	Left hand infill panel	4003466
66	Left hand glass panel	4004705
67	Right hand glass panel	4004706
68	Rear infill panel	4004804
69	Rear glass panel	4004704
70	Top liner panel	4003202
71	Side anchor	4004710
72	Side spacer (3)	4004711
73	2.5-4.5" hose clamp (2)	4000768

# Appendix C—Spare Parts

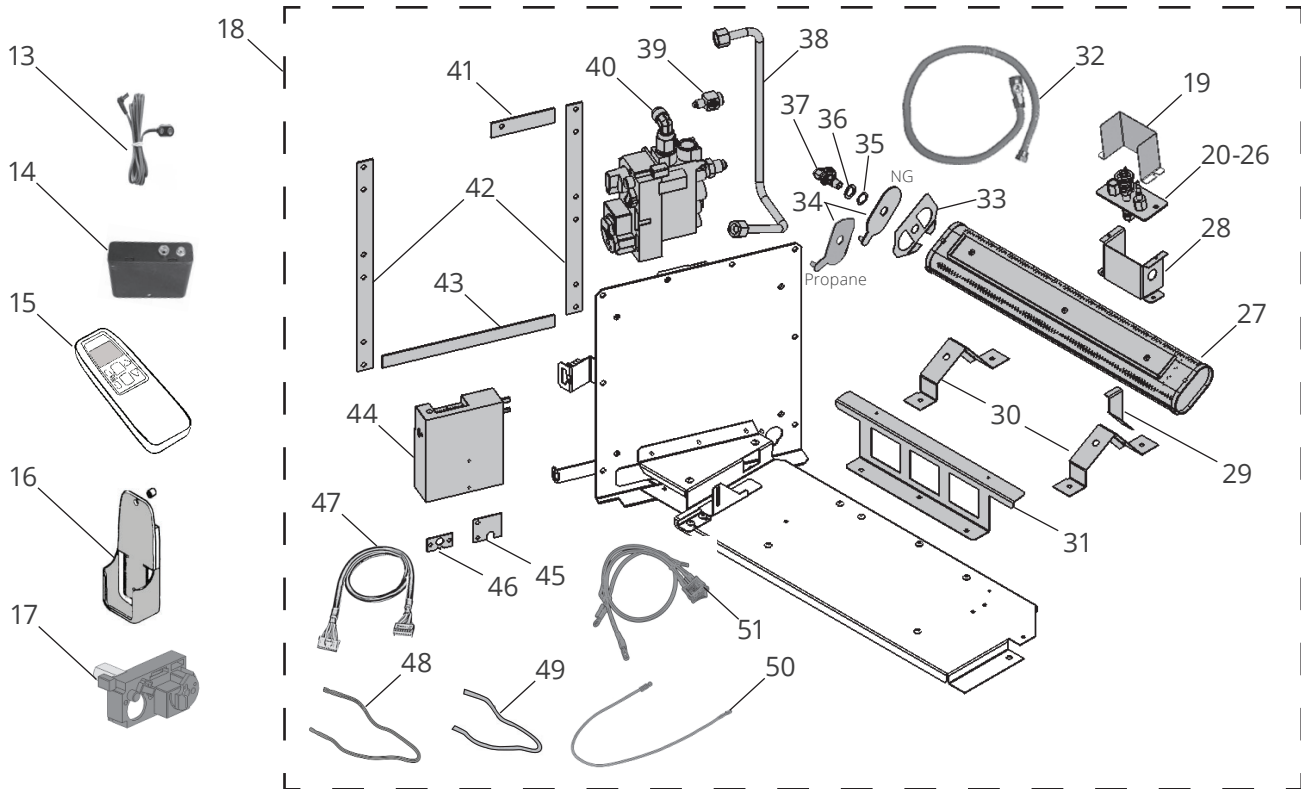
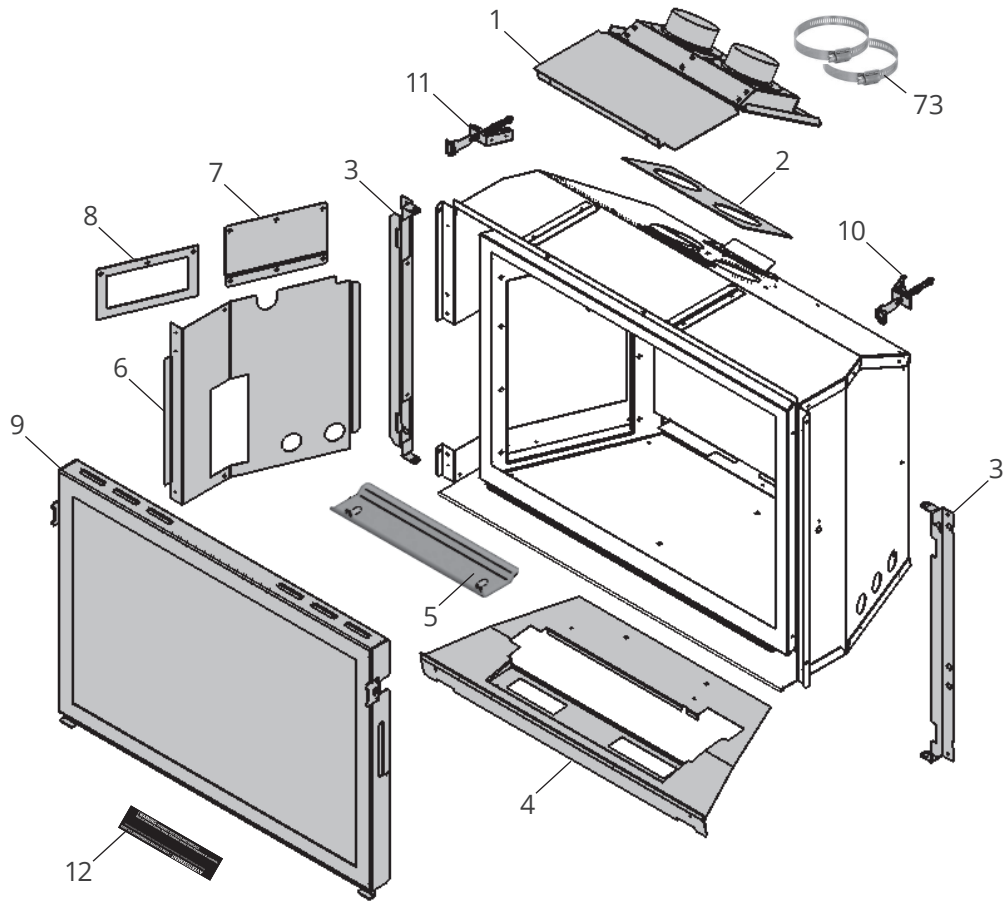

# Appendix C—Spare Parts

