

# Installation Manual



# G3

Gravity Vent Insert Gas Fireplace  
natural gas 738KN  
propane gas 738KP

Installer: Place model/serial number here.

Installer: Leave this manual with the appliance.  
Consumer: Retain this manual for future reference.

**⚠ WARNING:**  
**FIRE OR EXPLOSION HAZARD**

Failure to follow safety warnings exactly could result in serious injury, death, or property damage.

Do not store or use gasoline or other flammable vapors and liquids in the vicinity of this or any other appliance.

**WHAT TO DO IF YOU SMELL GAS**

- Do not try to light any appliance.

- Do not touch any electrical switch; do not use any phone in your building.
- Leave the building immediately.
- Immediately call your gas supplier from a neighbor's phone. Follow the gas supplier's instructions.
- If you cannot reach your gas supplier, call the fire department.

Installation and service must be performed by a qualified installer, service agency or the gas supplier.

## **⚠ DANGER**



Hot glass will cause burns.

Do not touch glass until cooled.

Never allow children to touch glass.

A barrier designed to reduce the risk of burns from the hot viewing glass is provided with this appliance and must be installed for the protection of children and other at-risk individuals.

**This appliance may be installed in an after-market permanently located, manufactured (mobile) home where not prohibited by local codes. This appliance is only for use with the type of gas indicated on the rating plate. This appliance is not convertible for use with other gases, unless a certified kit is used.**

**INSTALLER:** Leave this manual with the appliance.  
**CONSUMER:** Retain this manual for future reference.

**Massachusetts:**

The piping and final gas connection must be performed by a licensed plumber or gas fitter in the State of Massachusetts.

**⚠ WARNING**

This product can expose you to chemicals including Benzene, which is known to the State of California to cause cancer and birth defects or other reproductive harm. For more information go to [www.P65Warnings.ca.gov](http://www.P65Warnings.ca.gov).

Note: Natural gas, in its original state, contains Benzene.

This manual contains instructions to install the **ENGINE ONLY**. A trim kit is **REQUIRED** to complete the installation. A barrier screen is provided with the trim kit. **Refer to the manual supplied with the trim for installation.**

**This appliance is a domestic room-heating appliance. It must not be used for any other purposes such as drying clothes, etc.**

**This appliance is suitable for installation in a bedroom or bed sitting room.**

Ce guide est disponible en français sur demande.



We recommend a US Certified National Fireplace Institute (NFI) specialist install our gas hearth products.



The information contained in this manual is believed to be correct at the time of printing. Miles Industries Ltd. reserves the right to change or modify any information or specifications without notice. Miles Industries Ltd. grants no warranty, implied or stated, for the installation or maintenance of your heater, and assumes no responsibility for any consequential damage(s).

© Copyright Miles Industries Ltd., 2023. All rights reserved.  
Designed and manufactured for Miles Industries Ltd.

# Welcome to Valor®

This appliance has been professionally installed by:

Dealer Name: \_\_\_\_\_

Phone: \_\_\_\_\_

**Please read this manual BEFORE installing and operating this appliance.**

<b>Fireplace Safety .....</b>	<b>4</b>
<b>Specifications .....</b>	<b>6</b>
<b>Kits and Accessories.....</b>	<b>7</b>
<b>Dimensions.....</b>	<b>8</b>
<b>Clearances .....</b>	<b>9</b>
<b>Installation Planning.....</b>	<b>10</b>
Before Installation .....	10
Concept.....	11
<b>Venting .....</b>	<b>12</b>
<b>Preparation .....</b>	<b>13</b>
Existing Fireplace .....	13
<b>Installation .....</b>	<b>14</b>
Window.....	14
Appliance and Venting .....	15
Gas Supply.....	16
Liners .....	17
Fuel Bed Support .....	18
Fuel Beds .....	19
Traditional Log Kit 739TLK .....	19
Rock Set Kit 739RSK .....	22
Driftwood Kit 739DWK .....	24
Legend Traditional Logs 739LSK.....	26
Window Re-Installation and Checking .....	28
Batteries and Remote Control.....	29
Install Battery Holder .....	29
Synchronize Remote Control.....	29
Check Operation and Aeration .....	30
Front / Trim .....	31
<b>Wiring Diagram.....</b>	<b>32</b>
<b>Appendix A—Lighting Instructions.....</b>	<b>33</b>
<b>Appendix B—Remote Control Operation ....</b>	<b>34</b>
<b>Appendix C—Spare Parts .....</b>	<b>38</b>

# Fireplace Safety

This manual contains very important information about the safe installation and operation of the fireplace. Read and understand all instructions carefully before installing and operating the fireplace. Failure to follow these instructions may result in possible fire hazard and will void the warranty.

Replacement manuals are available by contacting the Valor Customer Service at 1-800-468-2567, or by visiting [valorfireplaces.com](http://valorfireplaces.com).

## **WARNING: Extremely Hot!**

### Heat and flammability

- Some parts of the fireplace are extremely hot, particularly the glass window. Use the barrier screen provided or a gate to reduce the risk of severe burns.
- The glass windows can exceed 500°F at full capacity.
- Always keep the appliance clear and free from combustible materials, gasoline, and other flammable vapors and liquids.
- Be aware of hot wall surfaces! The wall directly above the fireplace can get very hot when the fireplace heats. Although safe, it may reach temperatures in excess of 200°F (93°C) depending on choice of optional accessories. Do not touch!
- Be aware of hot shelf/hearth/floor surfaces! Any projections directly around the fireplace can get very hot when the fireplace heats. Although safe, they may reach temperatures in excess of 200°F (93°C) depending on their elevation. Be careful of touching these! Do not put objects on the hearth or shelf. Temperature of projection surfaces will be reduced when barrier screen is installed.
- Some materials or items, although safe, may discolor, shrink, warp, crack, peel, and so on because of the heat produced by the fireplace. Avoid placing candles, paintings, photos and other combustible objects sensitive to heat or furniture within 36 inches (0.9 m) around the fireplace.
- Solid wood flooring in front of the fireplace (if allowed) may shrink during the heating season due to heat.
- Due to high temperatures, the appliance should be located out of traffic areas and away from furniture and draperies.
- Clothing or other flammable material should not be placed on or near the appliance.

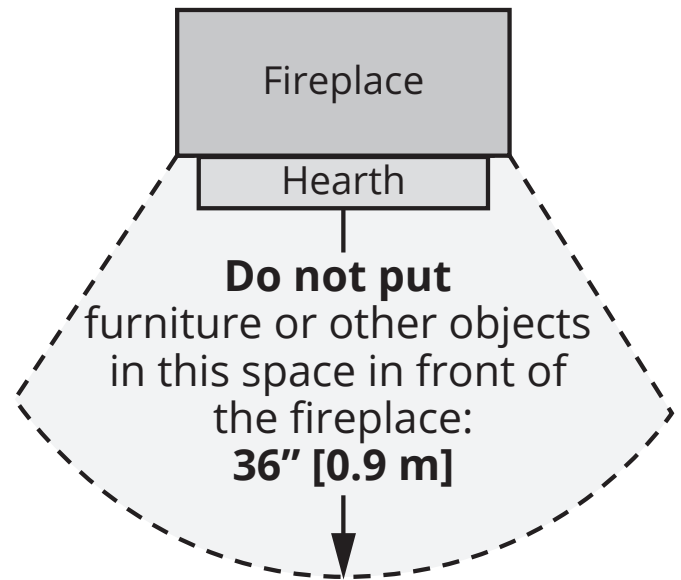

### Barrier Screen and Safety

- A barrier designed to reduce the risk of burns from the hot viewing glass is provided with this appliance and must be installed for the protection of children and other at-risk individuals.
- Children and adults should be alerted to the hazards of high surface temperature and should stay away to avoid burns or clothing ignition.
- Young children should be carefully supervised when they are in the same room as the appliance. Toddlers, young children, and others may be susceptible to accidental contact burns. A physical barrier is recommended if there are at-risk individuals in the house. To restrict access to a fireplace or stove, install an adjustable safety gate to keep toddlers, young children, and other at-risk individuals out of the room and away from hot surfaces.
- Any safety screen, guard, or barrier removed for servicing an appliance, must be replaced prior to operating the appliance.

# Fireplace Safety

## Glass window



### **WARNING**

**Do not operate this appliance with the glass front removed, cracked, or broken.**

**Do not strike or slam the glass front.**

**Replacement of the glass front should be performed by a licensed or qualified service person.**

- The glass front assembly must be in place before the unit can be placed into safe operation.
- The glass front assembly must only be replaced as a complete unit, as supplied by the fireplace manufacturer. No substitute material may be used.
- Do not use abrasive cleaners on the glass front assembly. Do not attempt to clean the glass when it is hot.

## Venting

- This unit must be used with a vent system as described in this manual. No other vent system or components may be used.
- Never obstruct the flow of combustion and ventilation air. Keep the front of the appliance clear of all obstacles and materials for servicing and proper operation.
- This gas fireplace and vent assembly must be vented directly to the outside and must never be attached to a chimney serving a separate solid fuel burning appliance. Each gas appliance must use a separate vent system. Common vent systems are prohibited.

## Intended use

- This appliance is designed and approved as a supplemental heater and provides the potential for most energy conservation when used while attended. The use of an alternate primary heat source is advisable.
- This unit is not for use with solid fuel.
- Do not use this heater as a temporary source of heat during construction.

## Installation and Servicing

- Installation and repair should be done by a qualified service person. The appliance should be inspected before use and at least annually by a professional service person. More frequent cleaning might be required due to excessive lint from carpeting, bedding material, et cetera. It is imperative that control compartments, burners, and circulating air passageways of the appliance be kept clean.
- Do not use this appliance if any part has been under water. Immediately call a qualified service technician to inspect the appliance and to replace any part of the control system and any gas control that has been under water.

# Specifications

## Approval & Codes

This appliance is certified to ANSI Z21.88/CSA 2.33 American National Standard / CSA Standard for Vented Gas Fireplace Heaters for use in Canada and USA, and to CGA 2.17-91 High Altitude Standard in Canada. This appliance is for direct vent installations.

This appliance complies with CSA P.4.1-15 Testing method for measuring annual fireplace efficiencies.

The installation must conform to local codes or, in the absence of local codes, with the National Fuel Gas Code, ANSI Z223.1/NFPA 54 or the Natural Gas and Propane Installation Code CAN/CGA-B149.1. Only qualified licensed or trained personnel should install this appliance.

This appliance must be electrically grounded in accordance with local codes, or, in the absence of local codes, with the National Electrical Code, ANSI/NFPA 70 or the Canadian Electrical Code, CSA C22.1.

## Ratings

Model	738KN	738KP
Gas	Natural	Propane
Altitude (Ft.)*	0-4,500 feet*	
Input Maximum (Btu/h)	24,000	24,000
Input Minimum (Btu/h)	6,500	13,000
Manifold Pressure (in w.c.)	3.95"	9.5"
Minimum Supply Pressure (in w.c.)	5"	11"
Maximum Supply Pressure (in w.c.)	10.5"	14"
Main Burner Injector Marking	82-650	92-260
Pilot Injector Marking	35	27
Min. Rate Bypass Screw	125	125

## \*High Altitude Installations

Input ratings are shown in BTU per hour and are certified without deration for elevations up to 4,500 feet (1,370 m) above sea level.

For elevations above 4,500 feet (1,370 m) in USA, installations must be in accordance with the current ANSI Z223.1 and/or local codes having jurisdiction. Heating value of gas in some areas is reduced to compensate for elevation—consult your local gas utility to confirm.

For installations at elevations above 4,500 feet (1,370 m) in Canada, please consult provincial and/or local authorities having jurisdiction.

## Supply Gas

Heater engine 738KN uses natural gas.  
Heater engine 738KP uses propane gas.

The supply pressure must be between the limits shown in the *Ratings* section.

The supply connection is 3/8" NPT female and located on the left side of the control valve. The gas line entry point is on the left hand side on the fireplace.

See *Gas Supply Installation* section for details.

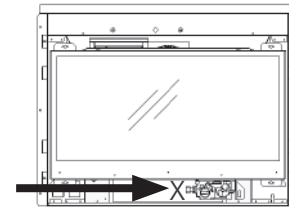

## Electrical

The 738K is designed to run on battery power and does not require an electrical source to operate as a heater.

## Conversion Kits

The 738K is supplied as natural gas or propane gas and is field convertible between fuels. See instructions packaged with the conversion kits for further information.

## Floor/Hearth

This appliance is approved for installation into existing solid-fuel burning fireplaces only. Combustible material such as plywood and so on may be used for leveling and shimming beneath the unit. This appliance does not require a hearth other than to support the weight of certain fronts.

## Outdoor Conversion Kit

The 738K models are supplied standard for indoor applications and may be adapted for installation in specific "outdoor" applications protected from weather as defined in the GV60CKO outdoor conversion kit manual.

## NOTE

This appliance is designed and approved as a supplemental heater and provides the potential for most energy conservation when used while attended. The use of an alternate primary heat source is advisable.

# Kits and Accessories

## Required Kits

Fuel Beds (choose one)		
739TLK	Traditional Log Kit	
739RSK	Rock Set	
739DWK	Driftwood Kit	
Liners (choose one)		
739RGL	Reflective Glass Panels	
739FBL	Fluted Black Panels	
739VRL	Valor Red Brick Panels	
Inner Fronts (choose one)		Barrier Screen
741	Contemporary Steel Front	4003360
742	Traditional Cast Front	4003293
743	FenderFire Double Door	w/Doors
744	FenderFire Single Door	
745	Clearview Front	4003313

## Optional Accessories

Outer Surrounds, Trims, and Frets	
See your dealer for your choice of Outer Surrounds, Trims, and Frets.	
Gas Conversion Kits	
738KNGK	Conversion Kit to Natural Gas
738KPGK	Conversion Kit to Propane Gas
Other Accessories	
770ZCK	Zero Clearance Kit
1265WSK	Wall Switch Kit
GV60CKO	Outdoor Fireplace Conversion Kit
Hearth Gate	Hearth gates such as Cardinal's VersaGate are available at retail stores carrying safety products for children.

Information accurate at the time of printing and subject to change without notice.

# Dimensions

## Dimensions

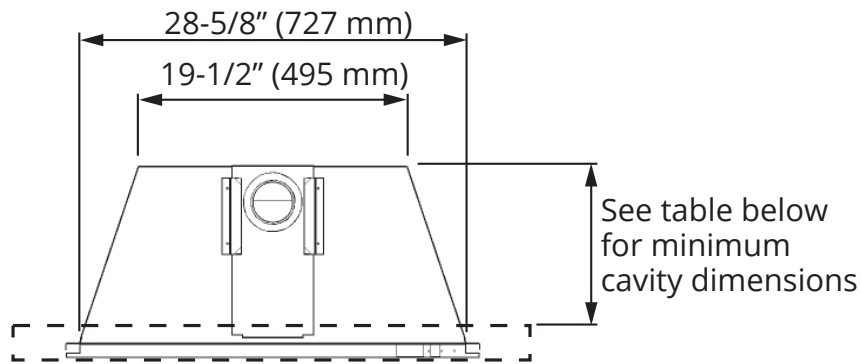

Top View

Optional Outer Trim or Surround sold separately

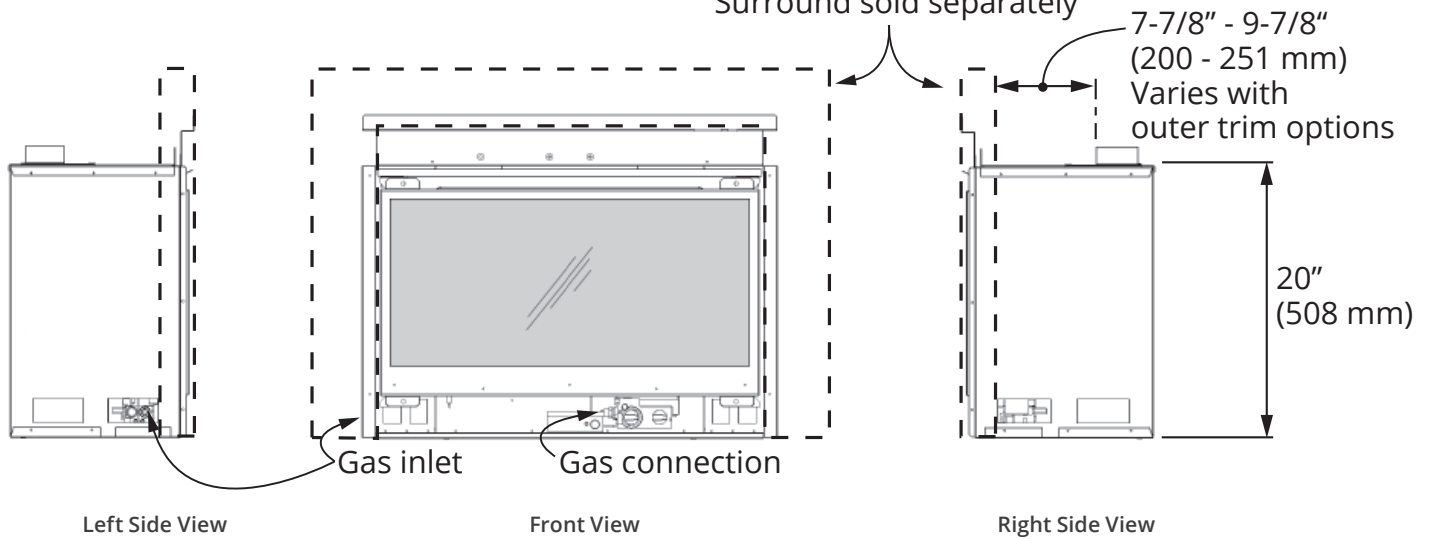

Left Side View

Front View

Right Side View

## Cavity

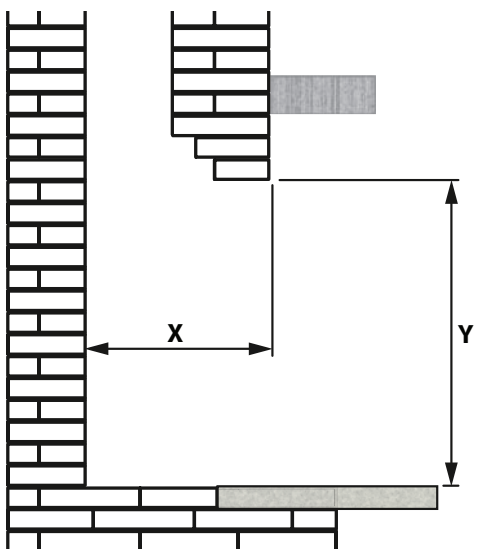

### Minimum Cavity Dimensions

Check that masonry step does not interfere with install dimensions or vent pipe.

If mantel is combustible, see the following section for allowable clearances.

Outer Trims	746CTK, 748CTK, 756ST, 767STB, 757ST, 715CV	747DTK, 753OTK
Minimum Depth (X)	12-7/8" [327 mm]	12-1/4" [312 mm]
Minimum Height (Y)	20-1/2" [521 mm]	20-1/2" [521 mm]
Minimum Width	28" [711 mm]	28" [711 mm]



# Clearances

## Mantel and Sidewall

### Combustible Mantel Clearances

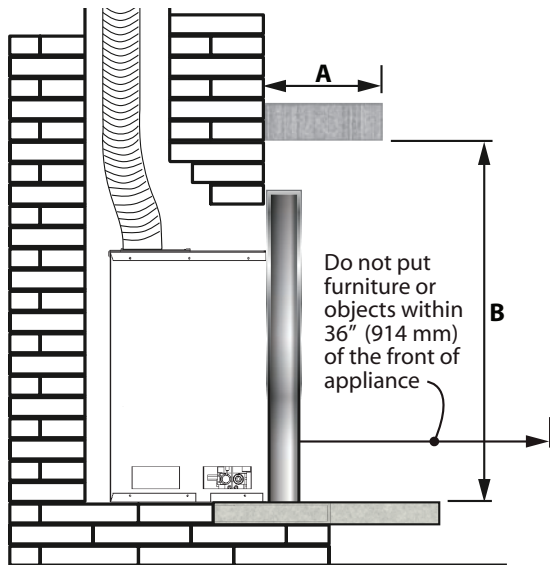

<b>Mantel Projection A</b>	1" [25 mm]	1-6" [25-152 mm]	9" [229 mm]	12" [305 mm]
<b>Mantel Height B*</b>	36" [914 mm]	39" [991 mm]	42" [1067 mm]	45" [1143 mm]

\*Measure taken from the underside of the mantel to finished hearth or surface that the unit is sitting on.

### Finishing Materials

**Combustible materials:** Materials made of or surfaced with wood, compressed paper, plant fibers, plastics, or other material that can ignite and burn, whether flame proofed or not, or plastered or unplastered.

**Non-combustible materials:** Material which will not ignite and burn. Such materials are those consisting entirely of steel, iron, brick, tile, concrete, slate, glass or plasters, or any combination thereof.

Materials that are reported as passing ASTM E 136, Standard Test Method for Behavior of Materials in a Vertical Tube Furnace at 750 °C

#### **⚠ WARNING**

**HOT GLASS!** The use of a screen in front of the glass is highly recommended particularly in households with children.

### Sidewall Clearances

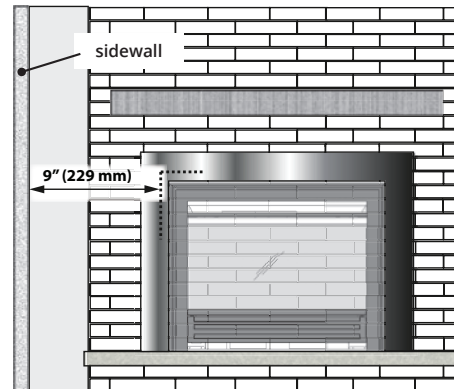

**Minimum** distance from side of appliance (liner box) to combustible wall: 9" [229 mm]. Mantel legs projecting forward less than 6" (152 mm) may be located within 5" (127 mm) of the side of the appliance (liner box).

### Floor/Hearth Clearances

Combustible shims/supports may be used beneath the appliance to level or raise the appliance within the existing fireplace cavity.

Combustible flooring/hearths in front of the appliance are allowed provided they are no higher than the base of the appliance. Carpet, vinyl flooring should be kept back to a minimum of 12" (305 mm) from the front of the insert. The gas insert does not require a hearth.

#### **⚠ WARNING**

**Some materials or items, although safe, may discolor, shrink, warp, crack, peel, and so on because of the heat produced by the fireplace. Avoid placing candles, paintings, photos, and other items sensitive to heat around the fireplace.**

#### **⚠ WARNING**

**HOT HEARTH / FLOOR!** The hearth or floor in front of the fireplace may become very hot when the fireplace heats. Do not use the hearth as a seat or shelf. Solid wood flooring in front of the fireplace (if allowed) may shrink during the heating season due to heat.

# Installation Planning

## Before Installation



### Caution

Only qualified, licensed, or trained personnel should install this appliance.

### Installer - READ THIS FIRST!

1. YOU NEED TO KNOW FROM THE HOMEOWNER:
  - What accessories (surround, screen, ZC kit, etc.) will be installed
2. Unpack the appliance, removing all items packed inside and around it. Recycle the packaging.
3. Check that you have everything, using the Pack Content sheet. Also, check that you have:
  - Fuel bed (packed separately)
  - Liner panels (packed separately)
  - Optional accessories (if ordered)
  - Gas conversion kit (if necessary)
  - Venting accessories
4. Carefully read the Installer's Checklist included with the fireplace for the installation sequence.

# Installation Planning

## Concept

This appliance, as supplied, may **ONLY** be installed in an existing unaltered, functioning solid-fuel burning fireplace with a working flue and constructed of non-combustible material.

This appliance may be installed in outdoor, weather-protected environments as defined in the GV60CKO Outdoor Conversion Kit instruction manual.

This appliance is **APPROVED** for installation into combustible type construction only when using the 770ZCK—Zero Clearance Kit (see separate instructions packaged with the kit for details).

### **⚠ WARNING**

Some materials or items, although safe, may discolor, shrink, warp, crack, peel, and so on because of the heat produced by the fireplace. Avoid placing candles, paintings, photos, and other items sensitive to heat around the fireplace.

### **⚠ WARNING**

**HOT HEARTH / FLOOR!** The hearth or floor in front of the fireplace may become very hot when the fireplace heats. Do not use the hearth as a seat or shelf. Solid wood flooring in front of the fireplace (if allowed) may shrink during the heating season due to heat.

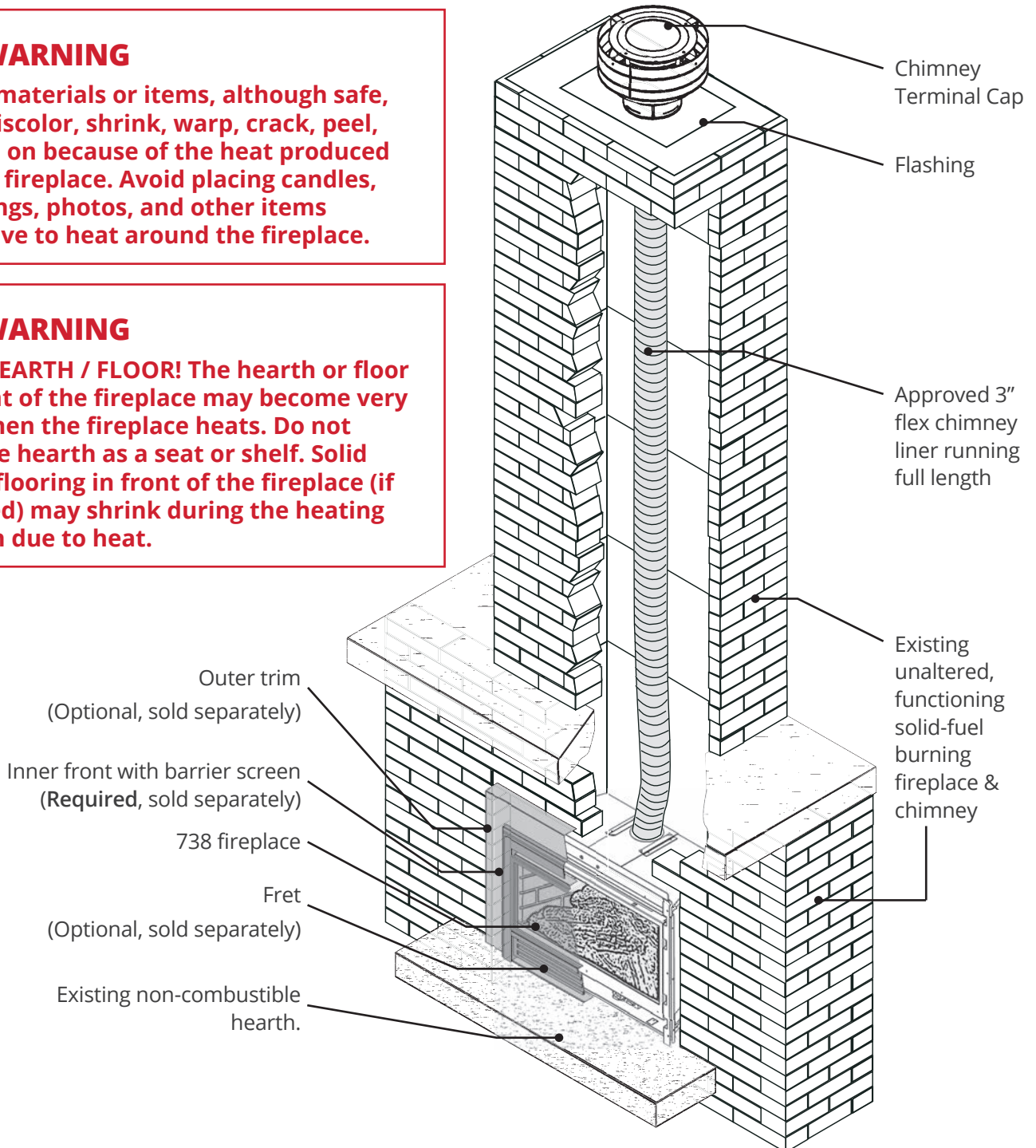

# Venting

## Concept

### Vent Location

The vent terminal must be located through the roof. This gravity vent appliance is designed to operate when an undisturbed airflow hits the outside vent terminal from any direction.

Check local codes for allowable vertical vent termination.

### Vent Materials

Use a 3" diameter aluminum flex liner approved for gas venting when installed as an insert (existing chimney). Use a 4" diameter type "B" vent when installed with a 770ZCK Zero Clearance Kit (see separate instructions packaged with the kit for details).

### Venting Notes

Where possible, avoid joining flex pipes. If joints are required, use a approved connector and seal joints with RTV high temp sealant.

Horizontal offsets are permissible to allow for routing around masonry projections. Avoid bending flex pipe over a 45 degrees radius where possible.

### Typical Vent Installation

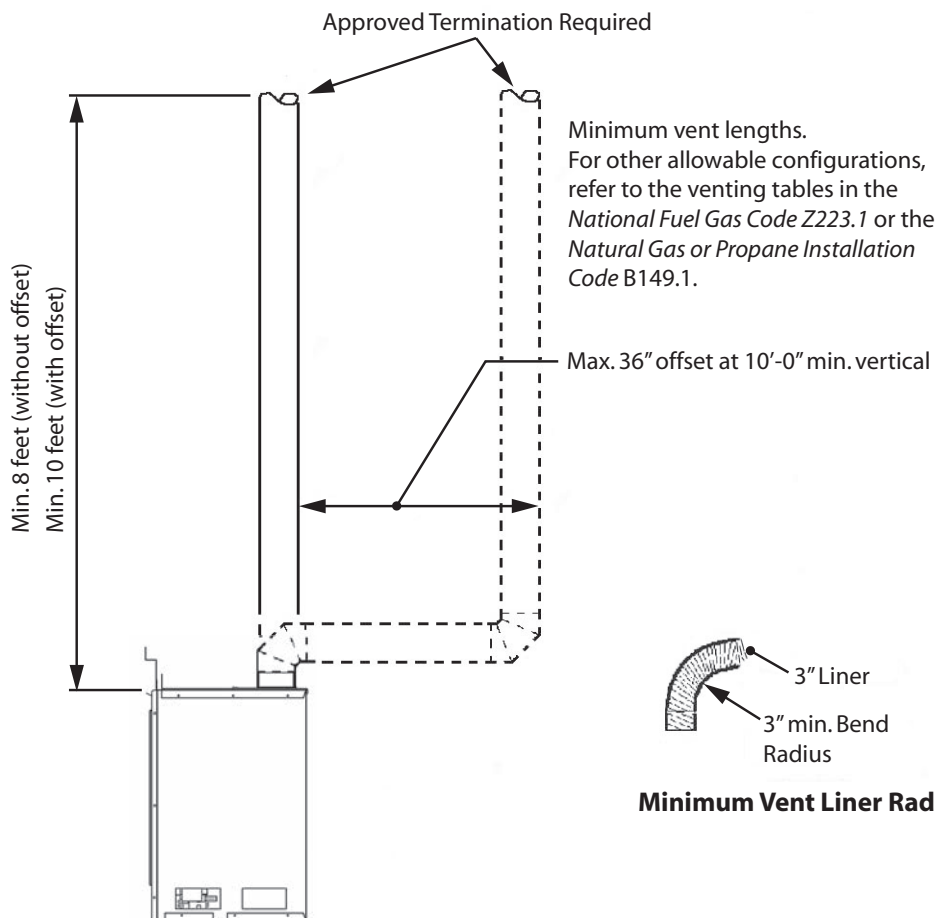
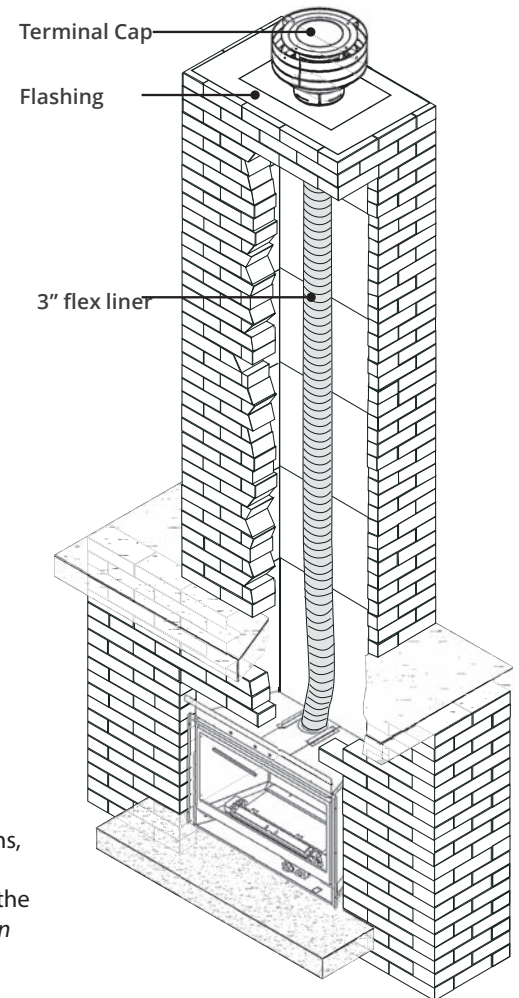

### Allowable Vent Configurations

# Preparation

## Existing Fireplace

### Existing Fireplace Preparation

A few points must be considered before inserting the 738 into an existing fireplace cavity. Generally, no modifications are allowed to the existing fireplace that will compromise the integrity of the existing fireplace. Components that are bolted or screwed on such as dampers or baffles may be removed to accommodate the installation of the 738 engine. Cutting away any sheet metal parts of the existing fireplace to accommodate the installation of the 738 is prohibited. Check with local authorities if in doubt.

### Clean Fireplace and Chimney

Have the chimney swept and the fireplace cavity including ash dumps and clean-outs cleaned before installing the 738 heater and vent liners. Any creosote or soot residue remaining in the fireplace cavity chimney or clean-out may cause odors or stains once the 738 insert is installed. Consult with chimney sweep for information on how best to clean.

### Existing Dampers

Factory-built, zero-clearance fireplaces will require the damper to be removed in order to install the vent liners. These dampers are usually bolted into place. Dampers in masonry fireplaces must be fixed open and may remain in place.

### Ash Retaining Curbs

Some fireplaces (particularly factory-built) have a raised curb at the front edge to retain ashes. Check the dimensions carefully to ensure the 738 engine will fit behind any raised curb (some curbs may be removed separately from the refractory base).

### Gas Line Routing

Plan the routing of the gas line before proceeding. Utilize the existing hole for the gas line of the factory-built fireplace.

If the fireplace has no access hole, carefully drill an access hole of 1.5 inch (38 mm) or less through the lower sides or bottom of the firebox. The access hole must be plugged with non-combustible insulation after the gas supply line has been installed.

See Dimensions section for detailed location of gas inlet. Also, take into consideration whether or not a fan or shut-off valve will interfere when planning routing of the gas line.

### Existing Glass Doors and Wire Screens

Existing glass doors must be permanently removed prior to installing the 738 insert.

### Combustible Mantels

Combustible mantel clearances must conform to those required for the original solid-fuel fireplace into which the 738 is being installed.

### Attach Warning Conversion Plate to Existing Fireplace

(plate supplied loose with 738 heater)

Attach the "This fireplace has been converted..." label to the existing fireplace using screws or other mechanical means and store any removed parts in back of the existing fireplace for future use.

# Installation

## Window

### Remove Window

The window is held in place by four spring-loaded bolts, two at the top and two at the bottom.

1. To remove the window, turn each bolt a quarter turn to disengage the bolt pin.
2. Gently pull the bottom of the window outward and unhook it from the firebox's opening frame.
3. Set the window aside in a safe place to avoid damage.

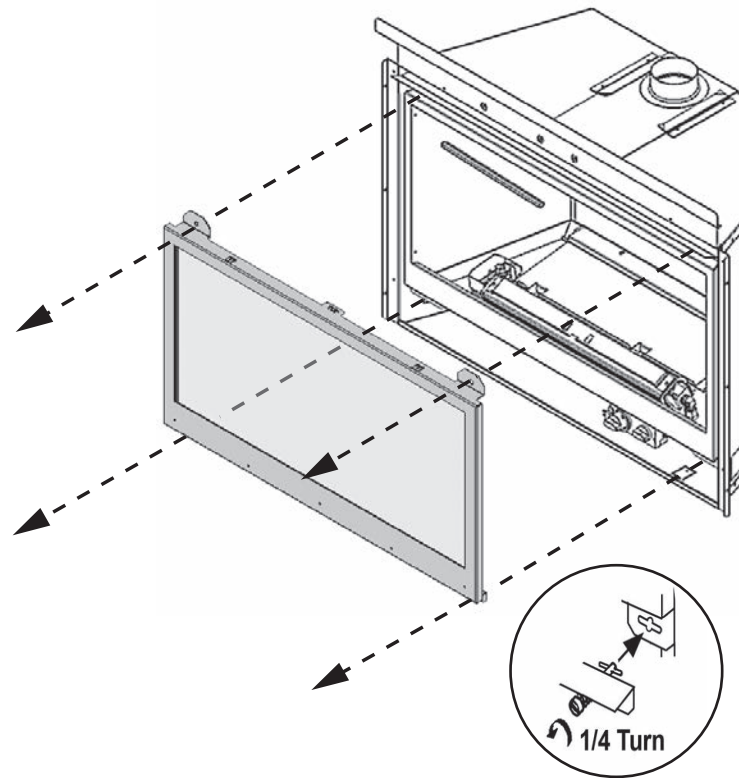

# Installation

## Appliance and Venting

### Connect Venting and Insert Appliance

**IMPORTANT:** This appliance's venting system require room air to be used in the combustion process.

1. Rough-in one 3" diameter vent liner into the existing chimney system from the roof. Be careful not to tear or damage the liner in the process. Leave plenty of liner at the bottom to facilitate the connection of the liner to the vent slider. **It is best to leave the top termination until later.**
2. Release the two screws retaining the vent slider to the front of the firebox. Remove the slider from the firebox by sliding it towards the back of the firebox.
3. Secure the liner to the collar on the vent slider using the hose clamp (included) and 2 tapping screws per liner.
4. Slide the firebox onto the vent slider in the cavity taking care not to damage the liner. **Make sure that the vent slider is pulled all the way forward.** Secure the vent slider to the front of the firebox with two screws removed earlier.
5. From the roof, pull the liner and fit the flashing.
6. Fit the terminal cap. Secure with screws.
7. Seal the terminal and flashing from water penetration as required.

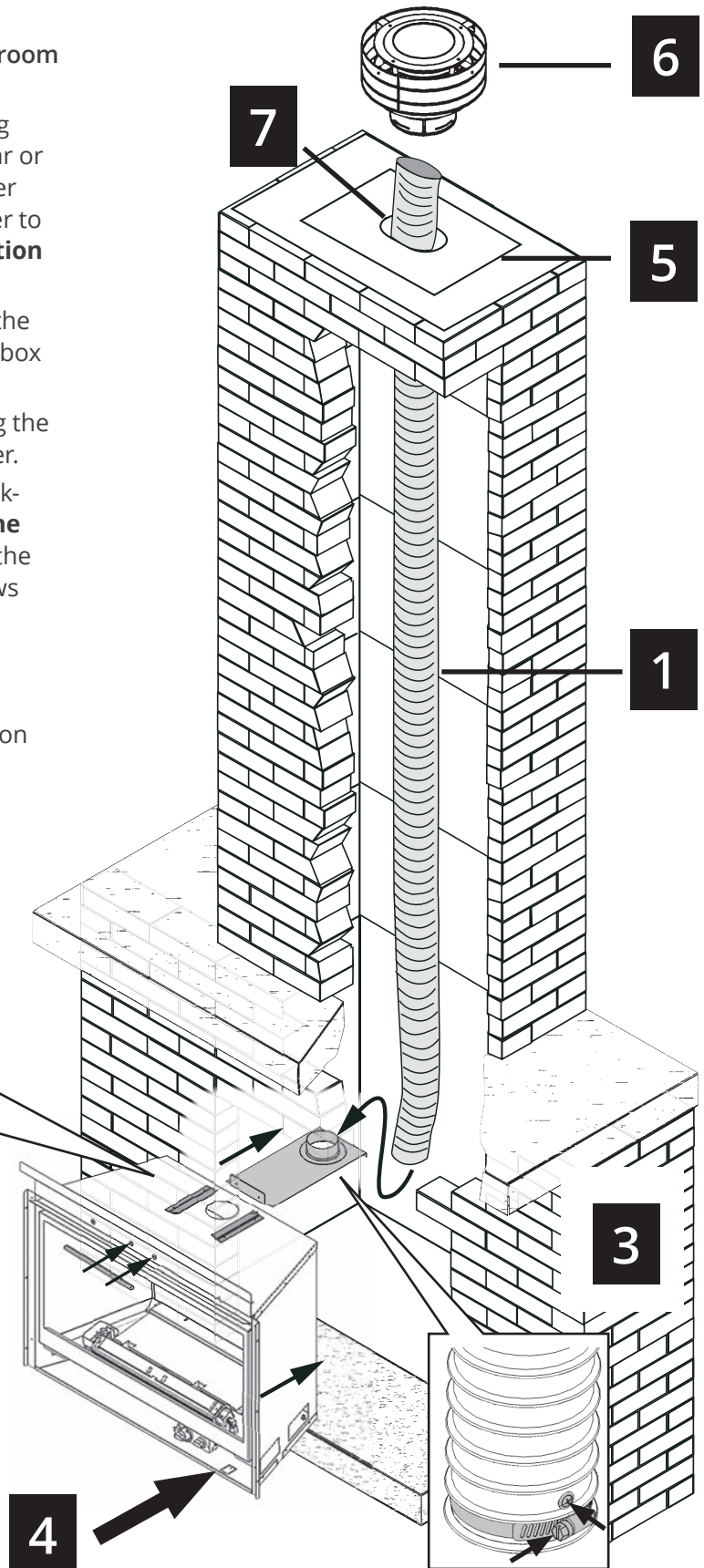
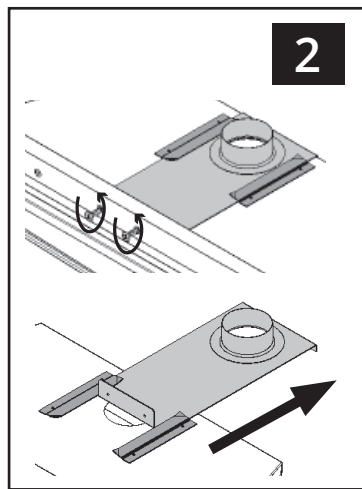

### **⚠ WARNING**

**Failure to position the parts in accordance with these diagrams or failure to use only parts specifically approved with this appliance may result in property damage or personal injury.**

### Connect Gas Supply

The gas supply inlet connection is a 3/8" NPT female connector and is located on the left hand side of the control valve.

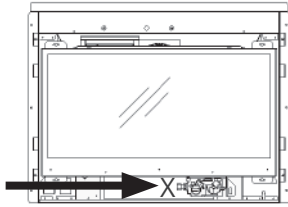

Use only new black iron or steel pipes, CSST, or copper tubing if acceptable—check local codes. Note that in USA, copper tubing must be internally tinned for protection against sulfur compounds.

The burner platform and gas train on this appliance may be removed as a unit for servicing or to install or remove the optional circulating fan (if installed). Provide some form of pipe union (depending on type of piping) as close as possible to appliance valve.

Unions in gas lines should be of ground joint type.

The gas supply line must be sized and installed to provide a supply of gas sufficient to meet the maximum demand of the appliance without undue loss of pressure.

Sealant used must be resistant to the action of all gas constituents including LP gas. Sealant should be applied lightly to male threads to ensure excess sealant does not enter gas lines.

Pressure test the supply line for leaks.

The appliance and its individual shut-off valve must be disconnected from the gas supply piping system during any pressure testing of that system at test pressures in excess of 1/2 psig (3.5 kPa).

The appliance must be isolated from the gas supply piping system by closing its equipment shut-off valve during any pressure testing of the gas supply piping system at test pressures equal to or less than 1/2 psi (3.5 kPa).

Failure to either disconnect or isolate the appliance during pressure testing may result in regulator or valve damage and void the warranty. Consult your dealer in case of damage.

### Pressure Test Points

The minimum supply pressure is given in the section Specifications of this manual— page 6.

All piping and connections must be tested for leaks after installation or servicing. All leaks must be corrected immediately.

When testing for leaks:

- Make sure that the appliance is turned off.
- Open the manual shut-off valve.
- Test for leaks by applying a liquid detergent or soap solution to all joints. Bubbles forming indicate a gas leak.



### WARNING

**NEVER USE open flame to check for leaks. Correct any leak detected immediately.**

The pressure test tapping locations are shown in the figure below. An internal regulator within the valve controls the burner manifold pressure.

The correct pressure range is shown in the table in section Specifications of this manual on page 6. The pressure check should be made with the burner alight and at its highest setting. See Lighting Instructions section for full operating details on page 33.

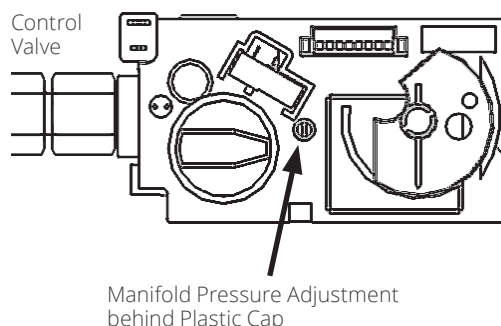
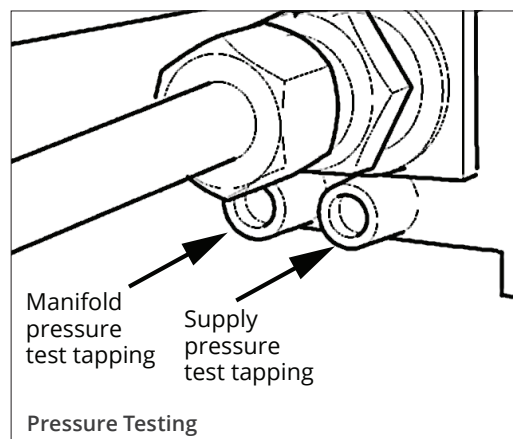



# Installation

## Liners

### Liner Installation

The following guidelines apply for all liners except the 739RGL Reflective Glass Liners which require some preparation prior to installation—see instructions packed with liners.

1. Inside the firebox, on the top of each side, release the screw of the side brick anchors (one per side) just enough to allow them to rotate.

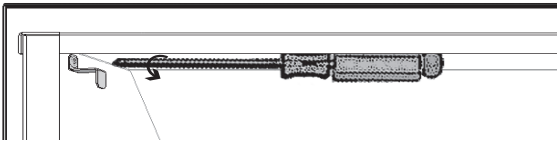

2. Place the rear panel against the back of the firebox, on the ledge at bottom.

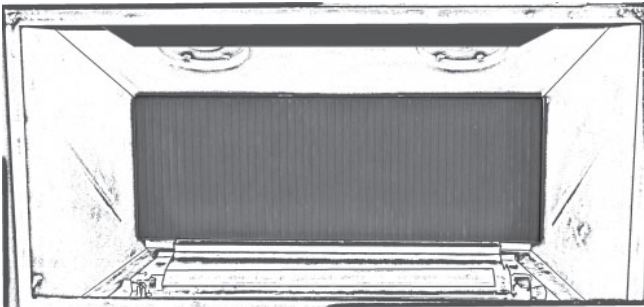

3. Rotate the anchor up and out of the way and slide the left hand side panel against the firebox side. The panel should be parallel to the edge of the burner plate. Rotate the anchor back down to hold the panel.



Rotate anchor up and insert panel

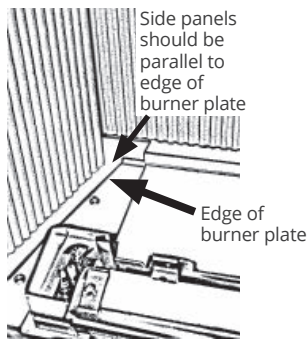

Position of panel in relation to burner plate

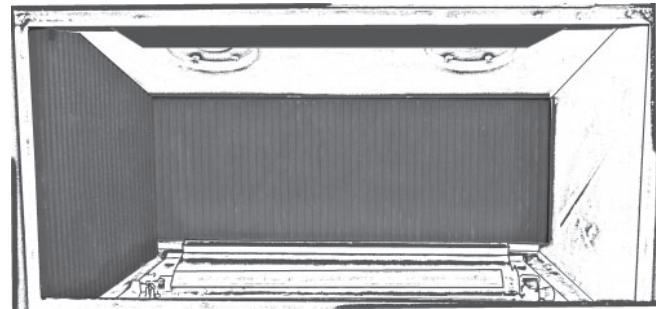

4. Rotate the anchor up and out of the way and slide the right hand side panel against the firebox side. The panel should be parallel to the edge of the burner plate. Rotate the anchor back down to hold the panel.

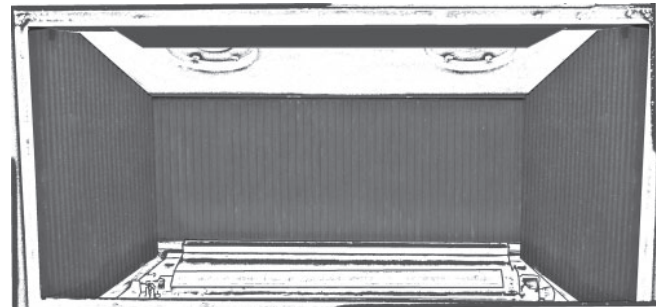

5. Tighten the side brick anchors on each side of the firebox.

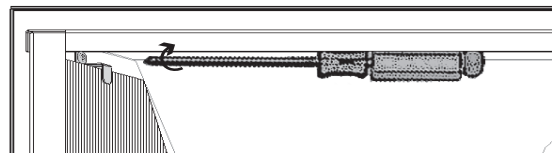

# Installation

## Fuel Bed Support

### Adjust Fuel Bed Support (if necessary)

The appliance is supplied with the fuel bed support with an adjustable bracket already installed in a specific position.

Unless otherwise indicated in the fuel beds' installation instructions, an adjustment is not necessary.\*

If desirable, the position of the bracket can be changed by releasing its 3 retaining screws, moving it as required and tightening the screws.

Moving the bracket forward will allow more impingement/glow/flame height; moving the bracket backward will do the opposite.

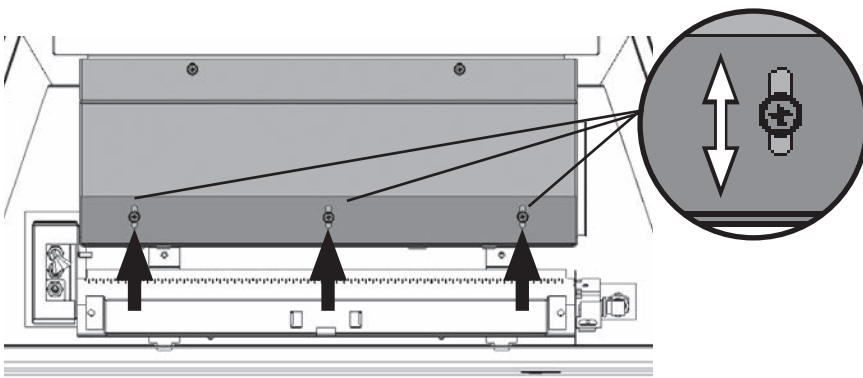

\*The adjustable bracket of the fuel bed support will need to be replaced by a different one to install the Traditional Logs Kit 739TLK. This bracket is included loose with the logs or the appliance. See 739TLK installation instructions.

# Installation

## Fuel Beds

### Traditional Log Kit 739TLK

#### Material required

- Traditional Log Kit, which contains:
  - 6 logs
  - 3 embers
  - 1 support bracket - log, supplied with logs or fireplace

#### Base Panel



G31



G32



G33

G34



G30

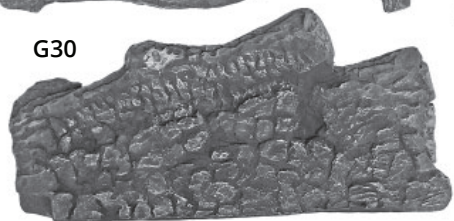

#### Embers



### Installation

Carefully unpack the kit. Note each log has its own number stamped on the bottom. Some logs have pegs to help you place them on the burner platform, or other logs.

#### Replace Fuel Bed's Support Bracket

The fireplace is supplied with the fuel bed support and bracket shown below. For this log set, the support bracket must be replaced by the bracket included loose either with the log set or the fireplace.

1. Remove the factory-installed fuel bed's support bracket (3 screws).

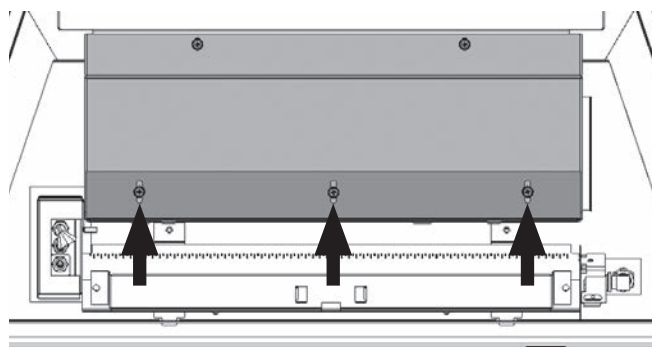

2. Install the support bracket supplied loose with the log set or fireplace, securing it re-using the same screws. Ensure the screws are centered in the bracket's slots as shown.

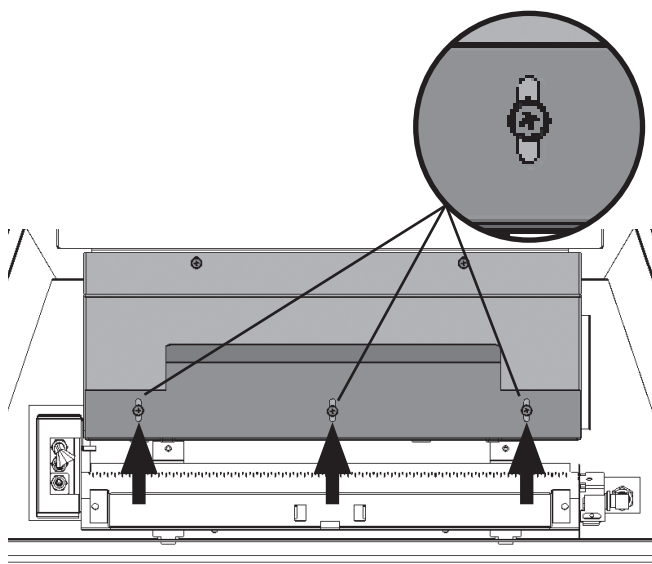

# Installation

## Fuel Beds

### Logs

1. Place log G30 on the fuel bed support; slide it left against the pilot shield. The front tabs of the support should be in the notches of the log.

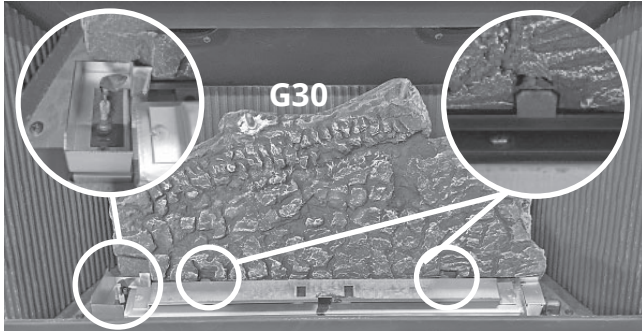

2. Place the base panel log on top of the burner, ensuring the vertical flange of the burner is inserted in the groove under the log as indicated.

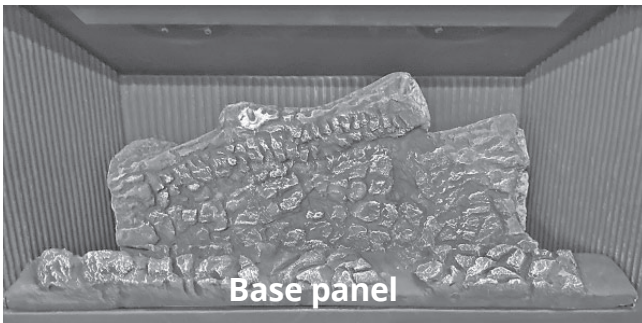
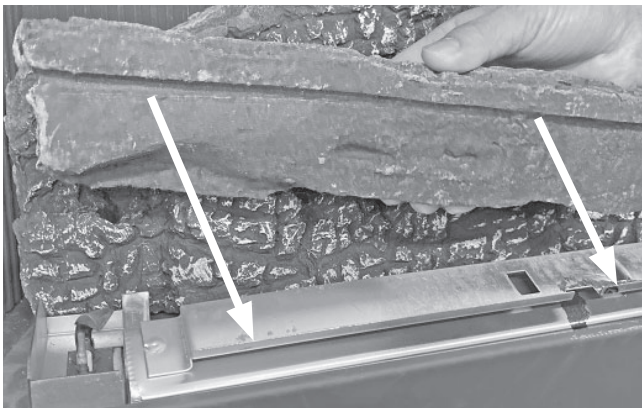

3. Place log G31 from pin on G30 to base panel.

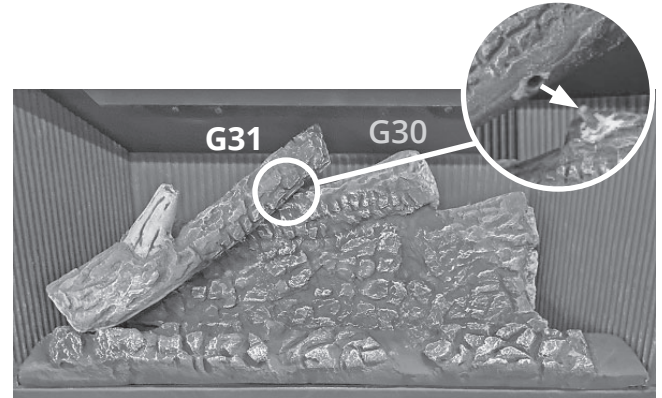

4. Place log G32 from pin on G30 to base panel.

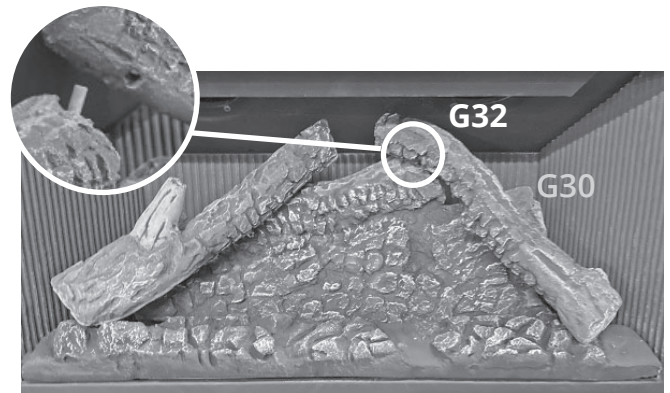

5. Place log G34 from base panel to rest against G30.



6. Place log G33 from base panel to rest against G30, underneath G31.



# Installation

## Fuel Beds

- Place 3 embers between logs in three gaps.

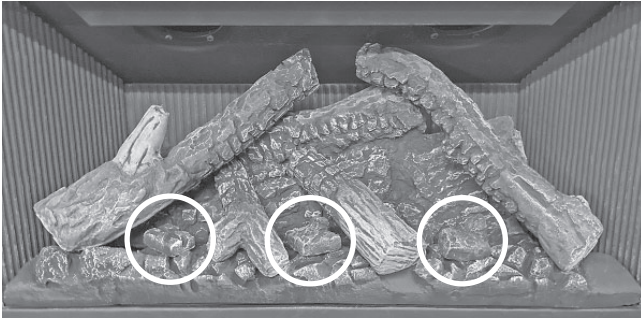

### **WARNING**

**Choking Hazard! Ensure that the fireplace area is clear of embers as these could be ingested by small children. Vacuum area after installation.**

### **IMPORTANT**

Approved for use only with the ceramic logs and embers provided with your Valor fireplace. The use of any other products may void your fireplace warranty.

739TLK Installed

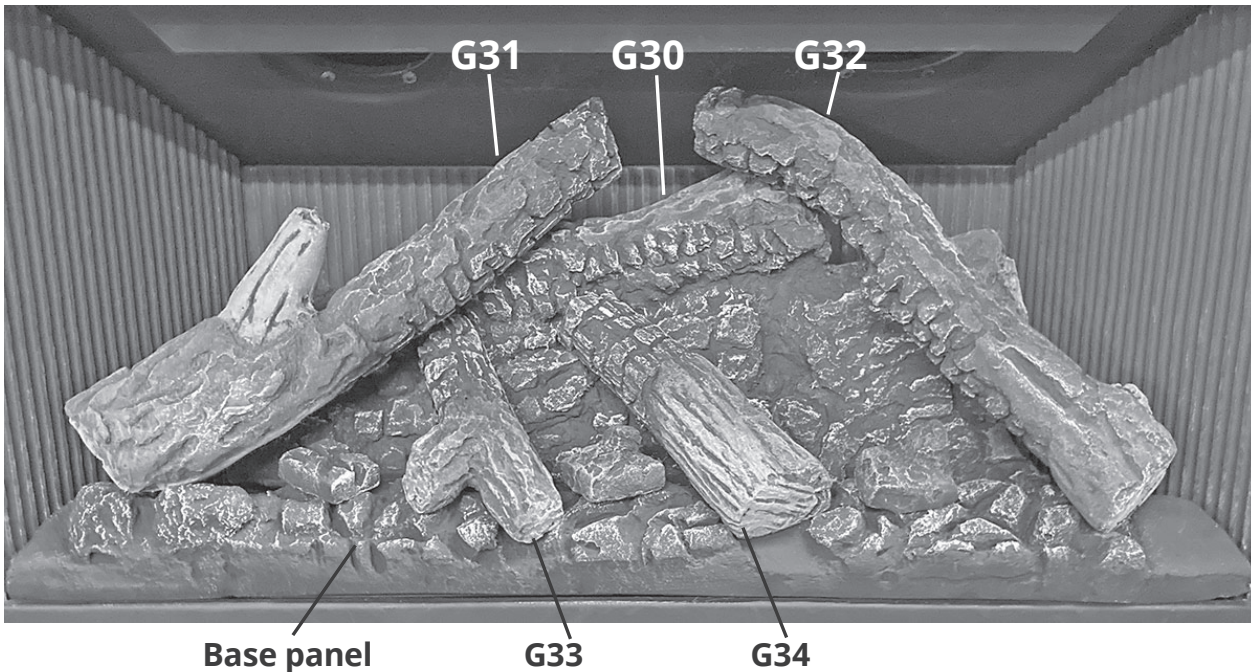

# Installation

## Rock Set Kit 739RSK

### Material required

- Rock Set Kit, which contains:
  - 6 rocks
  - 2 logs
  - ceramic platform
  - front support platform
  - glass panel
  - rock support

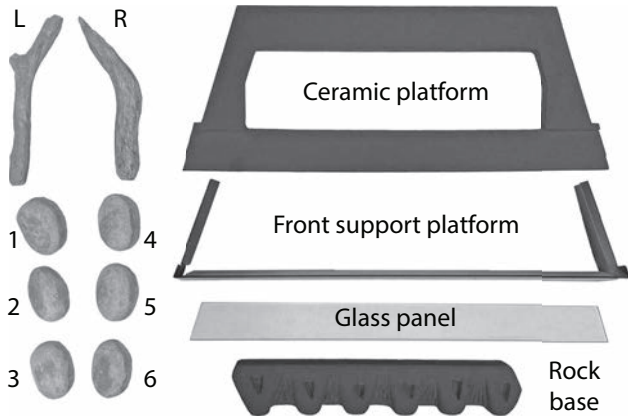

- Gloves, if desired

### Installation

Carefully unpack the kit. Note each rock has its own number stamped on the bottom. The rocks have pegs to help you place them on the rock support.

Install the kit as shown below.

1. Loosen the three screws holding down the fuel bed support and slide the flange all the way forward. Tighten the screws back down.

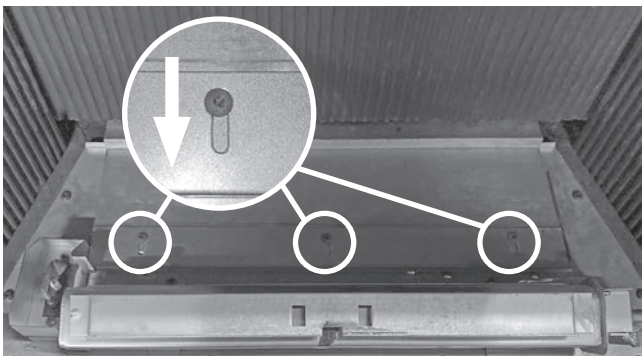

## Fuel Beds

2. Place the front support platform just inside the fireplace between the burner and the front edge of the firebox. Be careful not to damage the liner panels as the platform slides down into place.

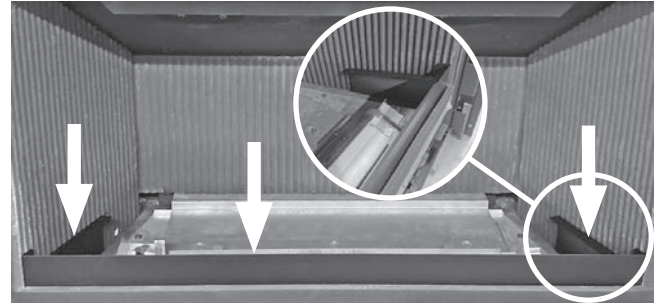
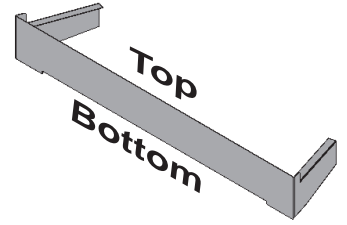

3. Place the rock support on top of the fuel bed support.

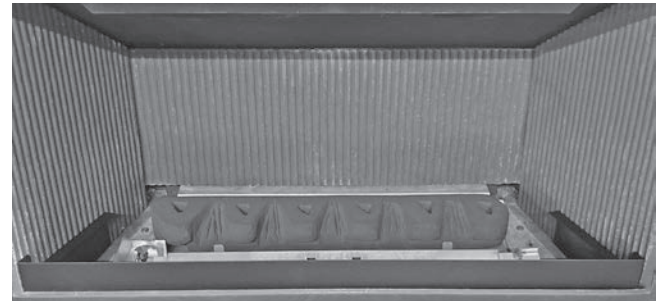

4. Place the ceramic platform as shown, fitting around the rock support.

**Warning: This platform is quite fragile. DO NOT force it into place!**

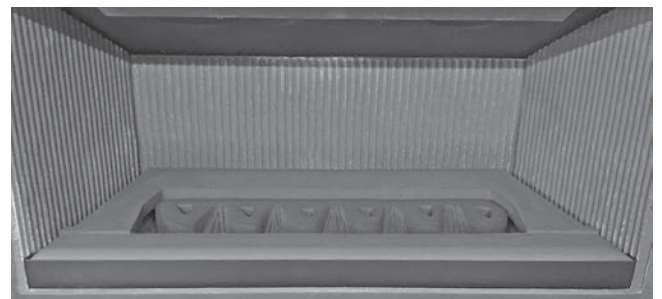

# Installation

## Fuel Beds

5. Place the 6 rocks into the rock support. They are stamped with numbers underneath; place 1 to 6 from left to right.

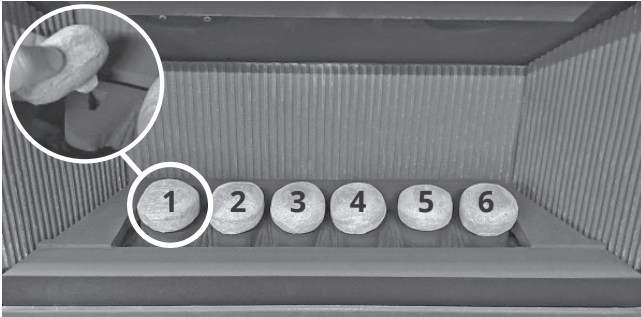

6. Place the glass panel in the cavity on the front of the ceramic platform.



7. Place the left log from the glass panel to rocks 2 and 3, and place the right log from the glass panel to rocks 4 and 5. Be careful to leave the gaps between rocks 1 and 2, and rocks 5 and 6 unblocked. The flame must be able to come up between the log and the end rock on each side.

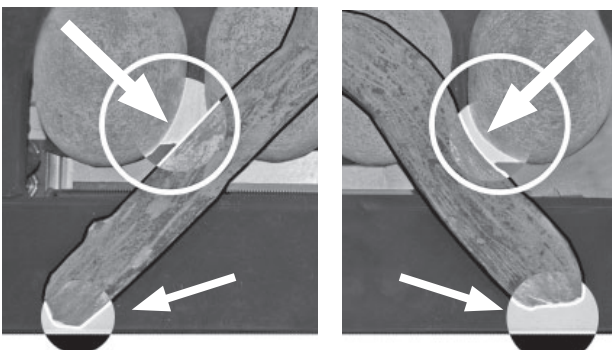
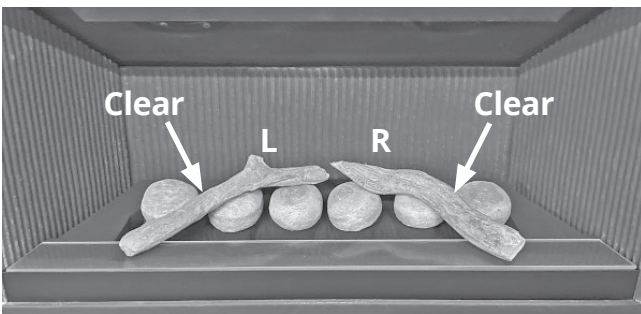

Installation is complete.



### Note

A black discoloration may form over time at the front bottom of the 6-rock original fuel bed; this deposit can be burned off by running the fireplace on a low to medium setting fire for 30 to 45 minutes. This discoloration is unavoidable and will re-form again.

### IMPORTANT

Approved for use only with the ceramic rocks and logs provided for your Valor fireplace. The use of any other products may void your fireplace warranty.

# Installation

## Fuel Beds

### Driftwood Kit 739DWK

#### Material required

- Driftwood Kit, which contains:
  - 5 logs
  - ceramic platform
  - 6 pebbles

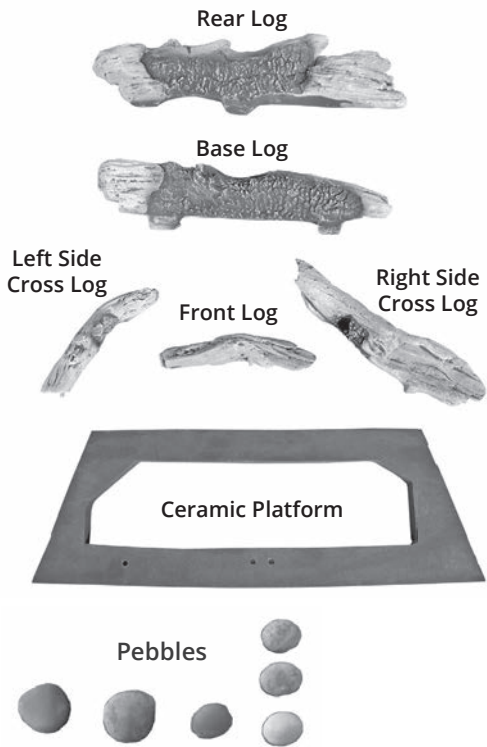

- Gloves, if desired

#### Installation

Unpack the driftwood kit very carefully to avoid damaging the fragile material. Install the components as shown below. Please note that **the position of the logs and pebbles (if used) is critical to ensure proper performance of the appliance.**

#### Platform

Place the platform into the firebox on top of the burner.

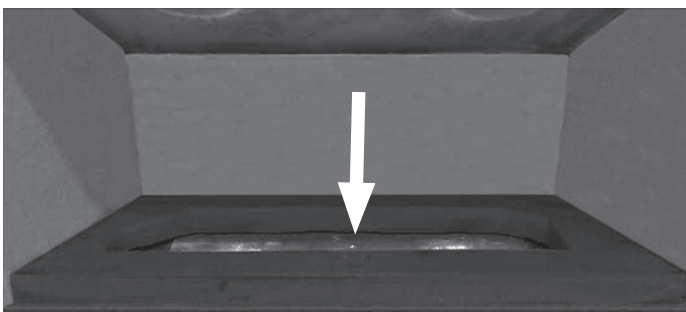

#### Logs

1. Identify the base log and place it in the cavity of the ceramic platform. The protruding parts of the log in the front should rest against the lip of the fuel bed support behind the burner.

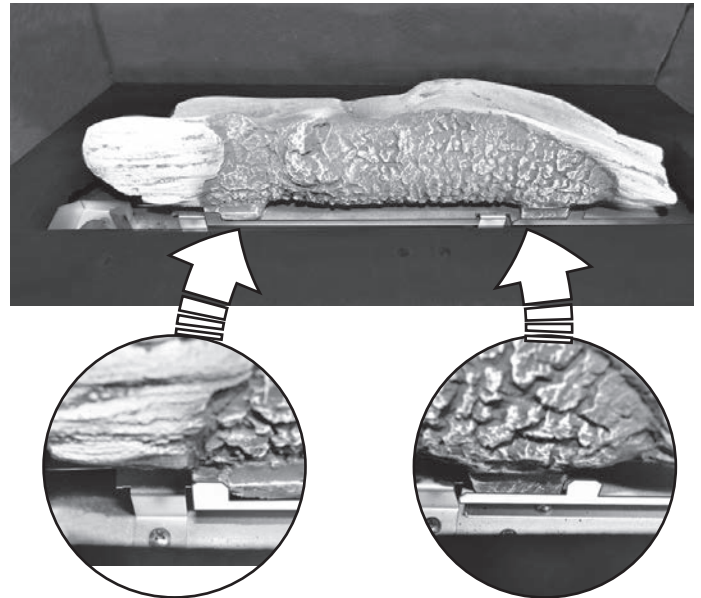

2. Identify the rear log and place it on top of the base log locating it into the notches on top of the log. Pull the log forward so it is locked in position.

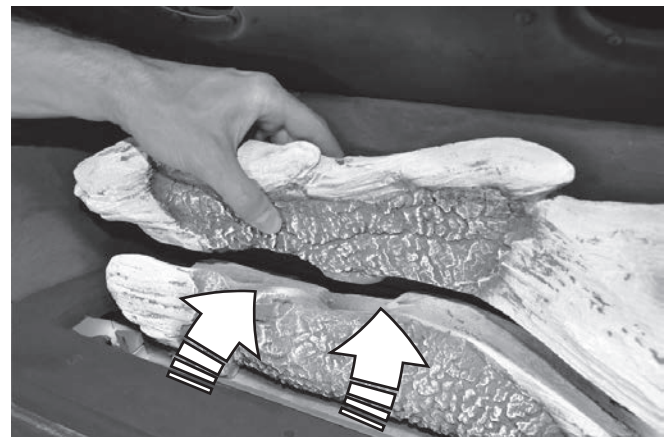



# Installation

## Fuel Beds

3. Place the front log inserting its two pins into the two holes at the front of the platform. The ends of the log should be oriented towards the front as the log should not hang over the inside edge of the platform.

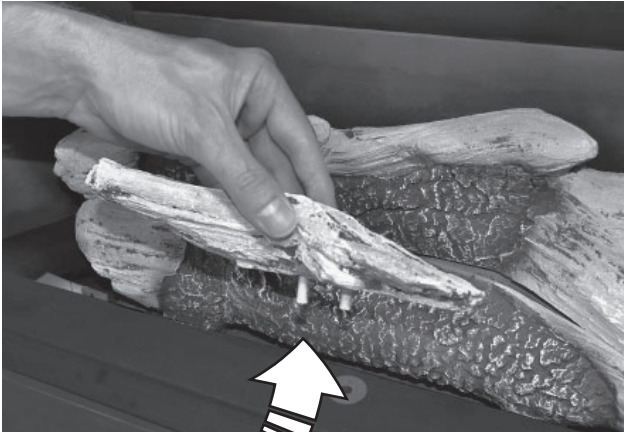

4. Identify the right side cross log, the longest, and place it across the rear log. The narrow end of the log rests in a notch of the rear log. The wide end of the log lays flat on the platform, flush with the edge as indicated.

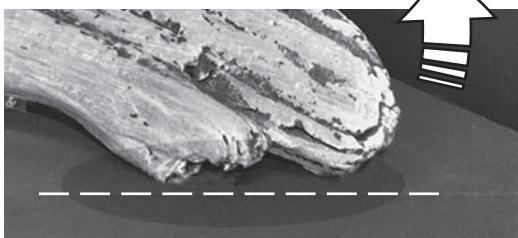
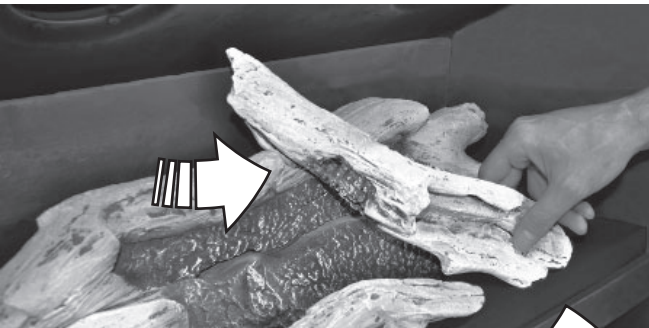

5. Identify the left side cross log which has one pin at one end. Insert the pin in the hole at the front left of the platform and rests the top part of the log into the notch of the rear log as indicated.

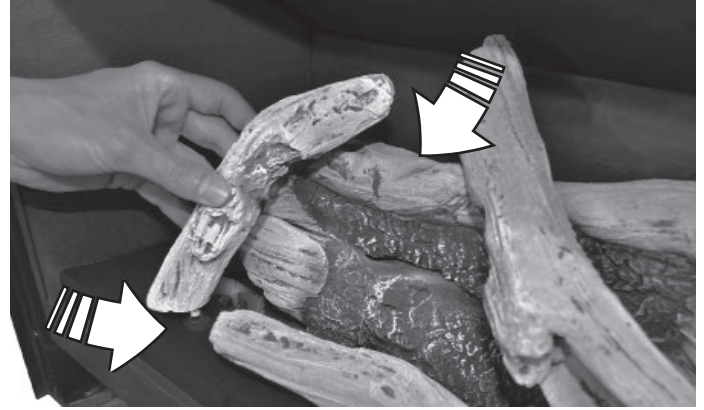

### Pebbles

Six pebbles are supplied as decorative elements. If used, they should be placed on the platform only. We suggest to place the larger ones to cover the inside edge corners of the platform and place others randomly. Not all of them have to be used.



### WARNING

**Choking Hazard! Ensure that the fireplace area is clear of pebbles as some of these could be ingested by small children. Vacuum area after installation.**

# Installation

## Fuel Beds

### Legend Traditional Logs 739LSK

#### Material required

- Traditional Log Set, which contains:
  - 6 logs
- Gloves, if desired, not included

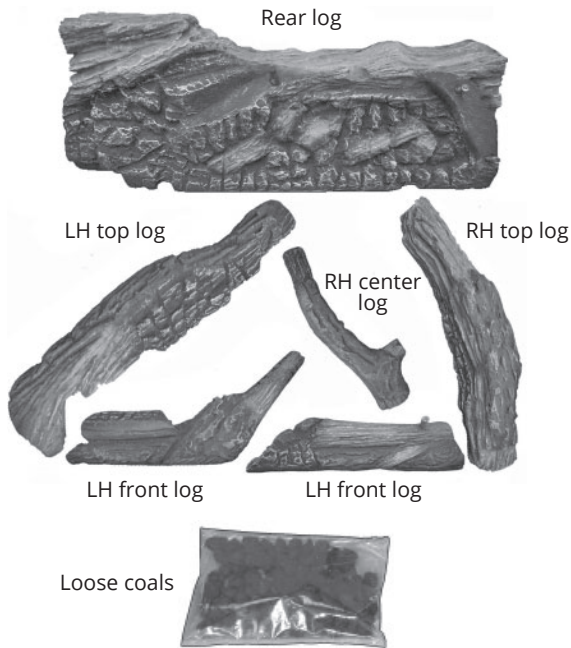

#### Installation

Carefully unpack the kit. Some logs have pegs to help their placement. Install the logs as shown below. Please note that the position of the logs is critical to ensure proper performance of the appliance.

#### **⚠ WARNING**

**Choking Hazard! Ensure that the fireplace area is clear of ceramic coal pieces as these could be ingested by small children. Vacuum area after installation.**

#### **IMPORTANT**

Approved for use only with the ceramic coal and logs provided for your Valor fireplace. The use of any other products may void your fireplace warranty.

1. Place the rear log on the sheet metal support centering it side to side in the firebox. Pull it forward until the notch in the underside of the log sits against front edge of the sheet metal support.

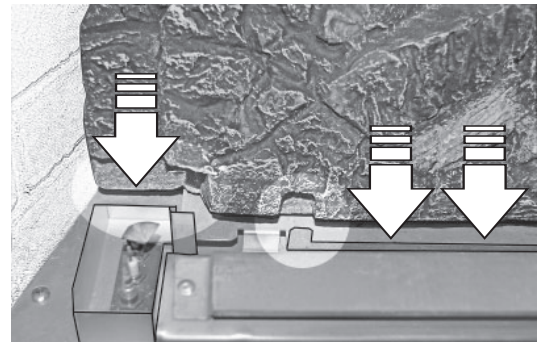
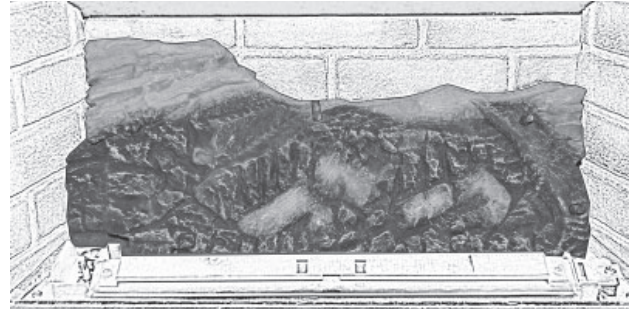

2. Place the top left log on the pin of the rear log. The bottom of the log rests against the left of the pilot shield and slightly above.

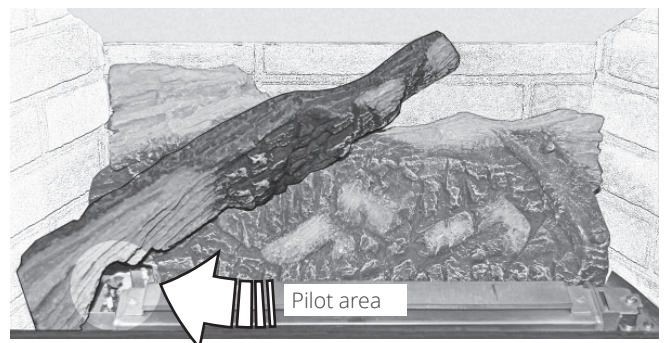

# Installation

## Fuel Beds

3. Place the front left log on the burner. Slide it to the left against the top left log. The narrow end should rest in the notch in the rear log.

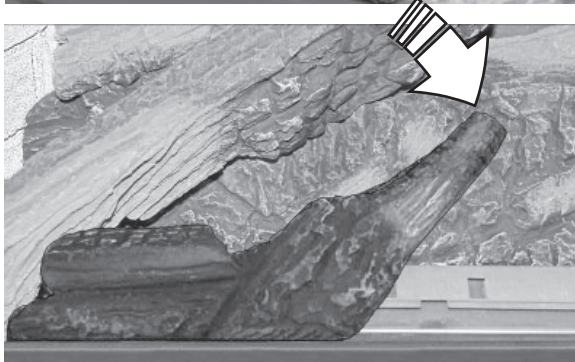
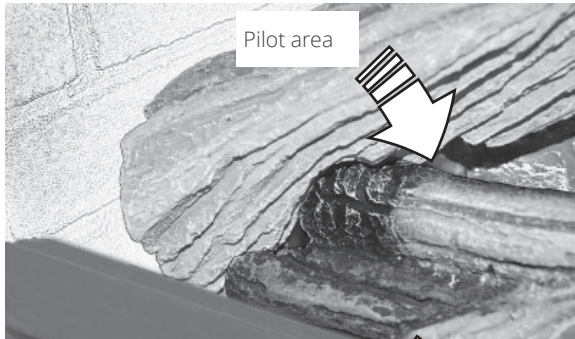

4. Place the front right log on the burner and slide it to the left against the front left log.



5. Locate the top right log on the two pins on the right side of the rear log. Ensure a tight fit against the flat area around the pins in the rear log.

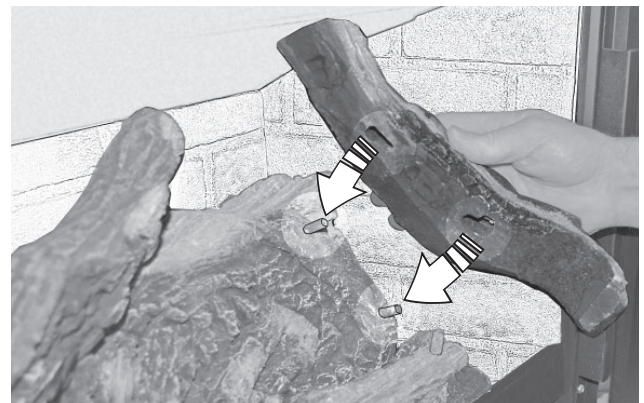

6. Place the lower end of the center right log onto the pin on the front right log. Rest the narrow end in the notch into the rear log.

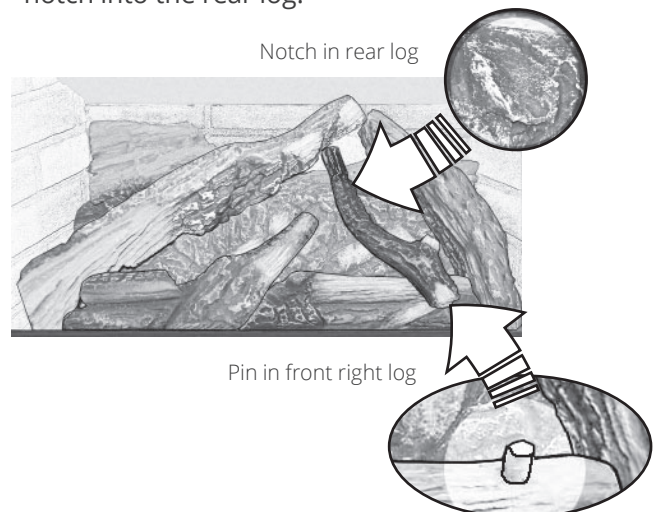

7. Pour some ceramic loose coals on each side of the logs to hide the sheet metal work. **Do NOT** put any coal into the pilot area.



# Installation

## Window Re-Installation and Checking

### Refit and Check Window

1. To refit the window, place the window against the firebox's opening frame. Make sure that the wider part of the window frame is at the bottom, and the "TOP" marker is at the top.

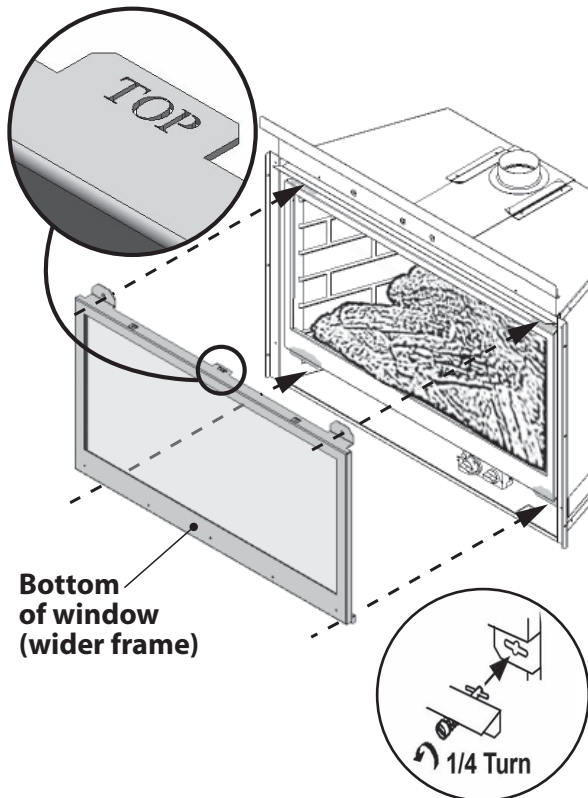

2. While you hold it, push in and turn the two top spring-loaded bolts a quarter turn to engage their pin.
3. Push in the bottom of the window against the firebox and fasten the two top spring-loaded bolts a quarter turn.
4. If the Hot Glass Warning plate has been removed from the front lower corner of the window, reinstall it by sliding it between the glass and the frame as indicated.

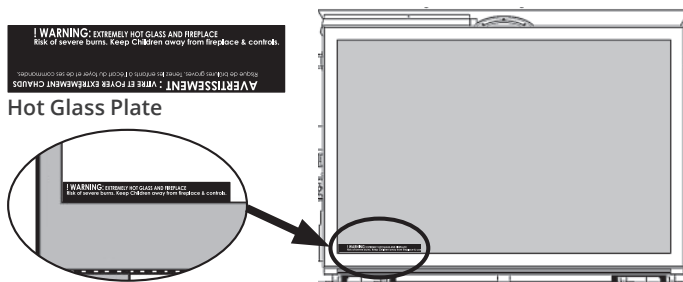

# Installation

## Install Battery Holder

The batteries that power the receiver need to be installed and placed prior to synchronization and use.

1. Take the receiver from under the firebox.
2. The battery holder and cable are supplied with the appliance. Insert 4 x 1.5V high quality alkaline batteries in the battery holder and 1 9V battery in the remote handset.



3. Connect the cable to the receiver.
4. Connect the other end of the cable to the battery holder.

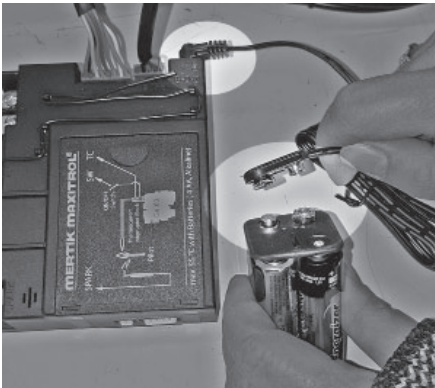

5. Place the receiver and battery holder as shown under the firebox, to the right of the control valve (placement may vary with installed options).
6. Use a heat resistant tie to gather any extra cable between the receiver and the holder.

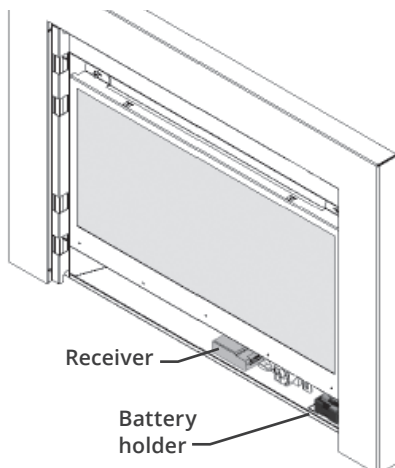

# Batteries and Remote Control

## Synchronize Remote Control

The receiver and the handset of the remote control system must be initially synchronized before the first use.

1. Insert one 9V battery into remote control handset.
2. With a thin object, press and hold the receiver's reset button until you hear one short and one long beep. Release the button after the second beep.

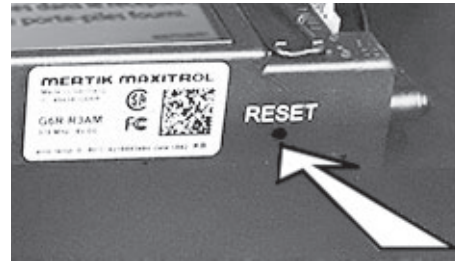

3. Within the subsequent 20 seconds, press the small flame button (Ⓓ) on the remote handset until you hear two short beeps confirming the synchronization is set.

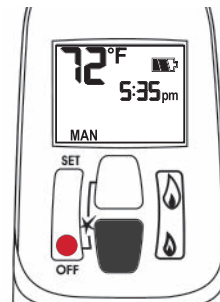

This is a one time setting only and is not required when changing the batteries in the remote handset. The remote control system is now ready to use.

### ⚠ Caution

DO NOT PUT batteries in the receiver as they could leak and damage the receiver.

### ⚠ Caution

DO NOT let the battery holder cable touch the burner plate above, it will melt during operation.

# Installation

## Check Operation

Turn the fireplace flame up and down using the remote control to confirm that the full range of inputs is achieved—see the Remote Control Use from page 34.

## Adjust Aeration (if necessary)

Light the fire and allow the unit to warm up for 10–15 minutes to evaluate the flame picture. Burners are equipped with an adjustable shutter to control primary aeration. See the figures at right. The shutters are factory-set to an aeration gap which will give optimum performance for the vast majority of installations.

Depending of fuel bed used, altitude and other considerations, the flame picture may be improved by adjusting the aeration. The need for adjustment should be determined only by operating the appliance with the fuel bed, liners and window installed and evaluating the flame picture after a 15-minute warm-up.

**Increasing aeration (open air shutter)** will cause the flames to appear more transparent and blue showing more ceramic effects glow.

**Decreasing aeration (close air shutter)** will cause the flames to appear more yellow or orange showing less ceramic effects glow.

***Too little aeration may result in black carbon forming and dropping into the firebox.***

## Check Operation and Aeration

### Air Shutters

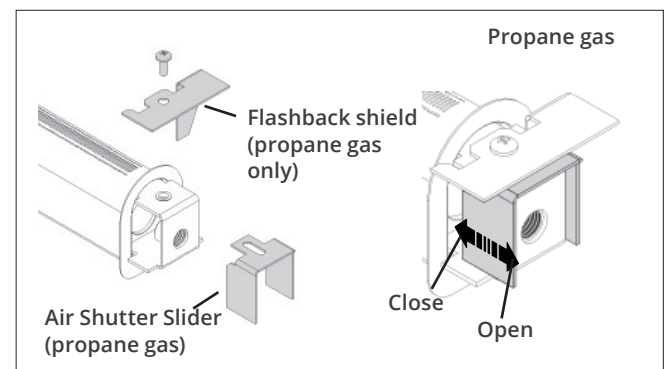
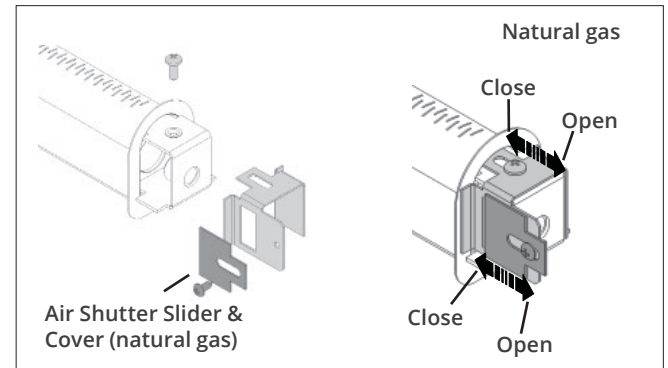

# Installation

## Front / Trim

### Sides Shrouds

The side shrouds are required to install the front and trim on the appliance. They are supplied with the appliance.

Secure them to the appliance outer case as indicated (2 screws/side).

Note that some backing or finishing plates may have to be installed before the side shrouds—see instructions packed with the plates/trim/front for all details.

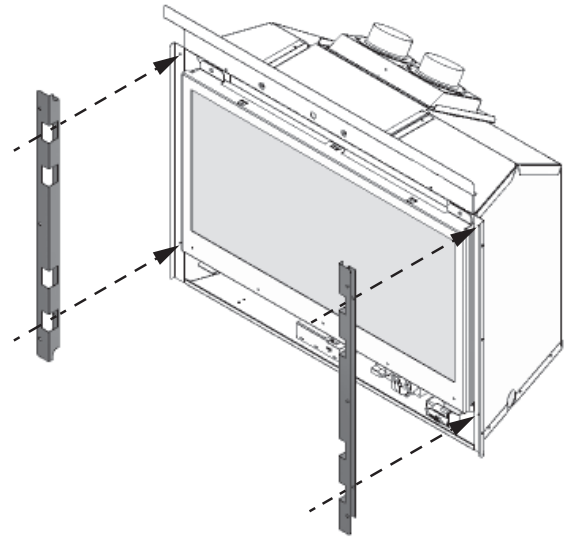

### Front, Trim and Barrier Screen

Install the front and trim chosen by the customer for their fireplace. Install as well the barrier screen which is provided with the front.

Show the customer remove the front and also how to access the controls when the front is installed.

Follow the instructions provided with the front and trim and leave those instructions behind for the customer's further reference.

### Remote Control Handset Wall Holder

The remote control kit for this fireplace comes complete with a wall-mounted holder. This holder is not required in all installations but is provided as an optional feature for those customers who wish to mount the remote handset to the wall.

To install the holder to the wall, find a convenient location and use the hardware provided with the kit.

**IMPORTANT:** The location of the remote control handset is important to assure proper temperature regulation. To obtain a constant temperature, we recommend that the handset should be **between 3 and 15 feet away from the appliance but not directly above it.** We also advise that the handset should be located away from any other heat source and not in direct sunlight as this may affect the temperature sensor located in the remote handset.

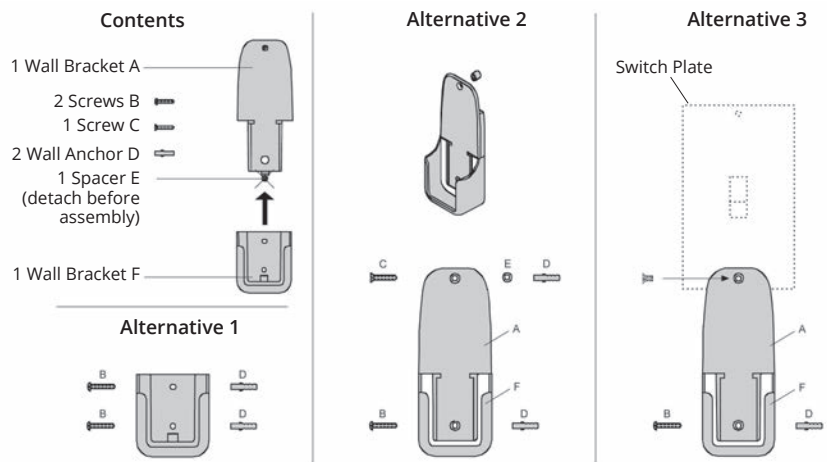

# Wiring Diagram

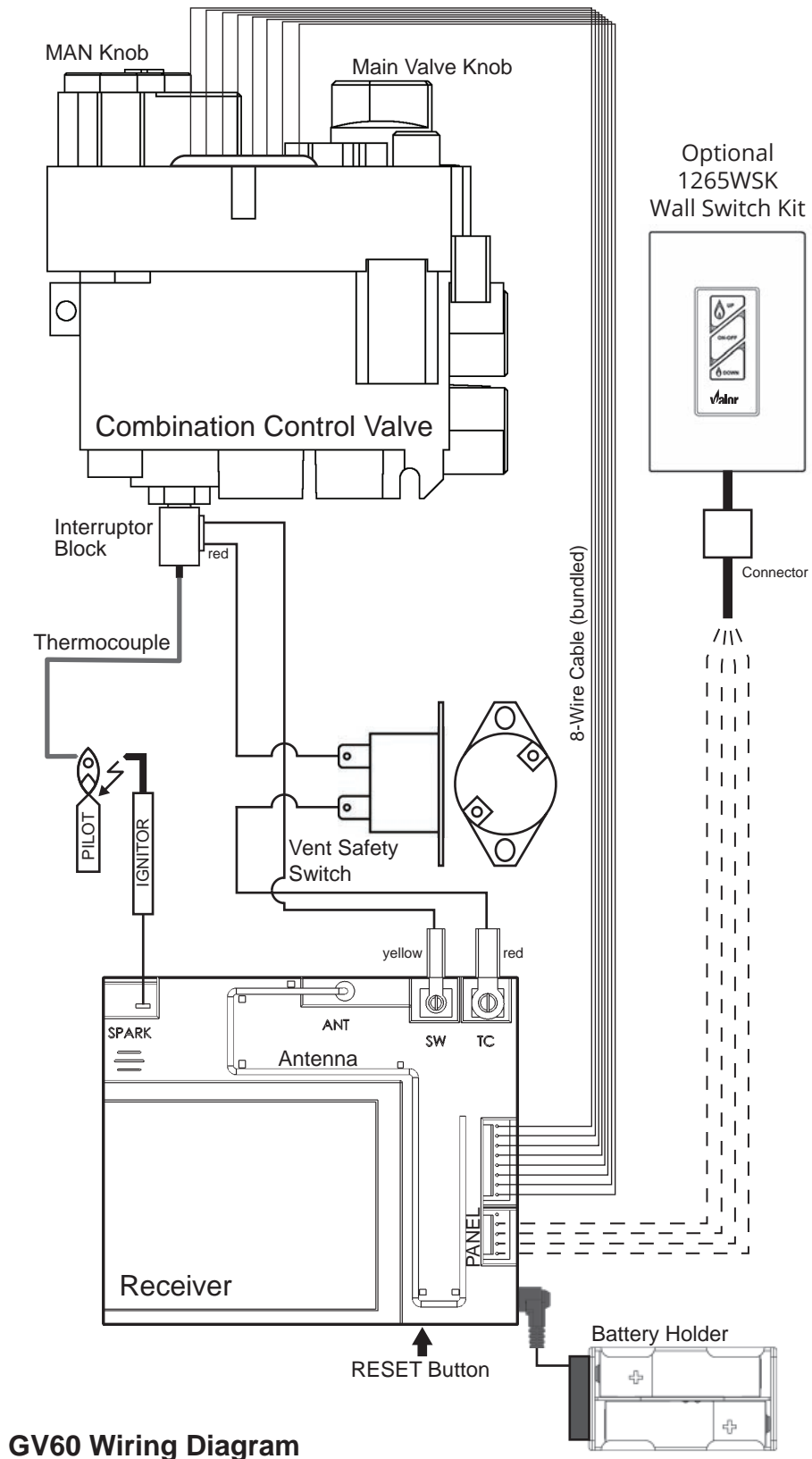

GV60 Wiring Diagram



# Appendix A—Lighting Instructions

## FOR YOUR SAFETY, READ BEFORE LIGHTING

**WARNING:** If you do not follow these instructions exactly, a fire or explosion may result causing property damage, personal injury or loss of life.

- A. This appliance has a pilot which must be lighted by hand or by remote control. Follow these instructions exactly. To save gas, turn the pilot off when not using the appliance for a prolonged period of time.
- B. **BEFORE LIGHTING**, smell all around the appliance area for gas. Be sure to smell next to the floor because some gas are heavier than air and will settle on the floor.
- WHAT TO DO IF YOU SMELL GAS**
- Do not try to light any appliance.
  - Do not touch any electric switch; do not use any phone in your building.
  - Immediately call your gas supplier from a neighbor's phone. Follow the gas supplier's instructions.
  - If you cannot reach your gas supplier, call the fire department.
- C. Use only your hand to push in or turn the control knobs. Never use tools. If the knobs will not push in or turn by hand, don't try to repair them; call a qualified service technician. Force or attempted repair may result in a fire or explosion.
- D. Do not use this appliance if any part has been under water. Immediately call a qualified service technician to inspect the appliance and to replace any part of the control system and any gas control, which has been under water.

## LIGHTING INSTRUCTIONS

1. **STOP!** Read the safety information above.
2. **TO CLEAR ANY GAS**, turn main valve off by pressing OFF (red dot) button on remote handset (1).
  - Wait five (5) minutes to clear out any gas, then smell for gas, including near the floor. If you smell gas, STOP! Follow "B" in the safety information above on this label. If you don't smell gas, go to the next step.
3. **AUTOMATIC IGNITION: MAN-knob (2) in ON position. Ensure Flame Adjustment knob (3) is set to lowest setting (↺) (Fig. 1). Locate the pilot (Fig. 3.) inside of firebox.**
  - ON/OFF wall switch (1) in ON position,
  - On the remote control handset, press the OFF button (red dot) and large flame button (🔥) simultaneously; a short acoustic signal confirms the start has begun.
  - Further short acoustic signals indicate the ignition process is in progress.
  - When the pilot is lit, the Flame Adjustment knob (3) will automatically rotate to the highest setting
  - Press the small flame button (🔥) on the remote control handset to reduce the flame height
4. **MANUAL IGNITION: MAN-knob (2) in MAN position (Fig. 2). With the window off, locate the pilot (fig. 3) inside of the firebox.**
  - Set Flame Adjustment knob (3) to the lowest setting (↺).
  - Push down the metallic core (4) with a pen or similar instrument; this will establish the pilot gas flow.
  - Light gas at the pilot (5) with a match.
  - Continue holding down metal core (4) for about 10 seconds; after release, pilot should remain lit.
  - If the pilot will not stay lit after several tries, turn the gas control knob (3) to OFF (↻) and call your local service technician or gas supplier.
  - Reinstall the window and set the MAN-knob (2) to ON; turn Flame Adjustment knob (3) up (↻) or down (↺) manually or use the flame buttons (🔥) (🔥) buttons on the remote control handset to adjust the flame height.

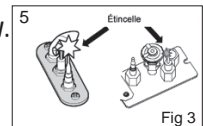
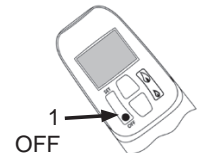
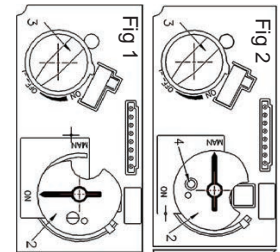

## TO TURN OFF GAS TO APPLIANCE

1. **AUTOMATIC SHUT-OFF** (using the remote control handset):
  - Press and hold the 🔥 (small flame) on the remote control handset to shut-off the main burner gas flow;
  - Press "OFF" button (red dot) on remote handset to shut-off the appliance, including pilot flame.

# Appendix B—Remote Control Operation

## Initial Pairing

Before the remote control can be used with the fireplace, it must be paired. See page 29.

## Radio Frequency

315 MHz for USA and Canada.

This device complies with Part 15 of the FCC Rules and with Industry Canada license-exempt RSS standard(s). Operation is subject to the following two conditions:

- (1) this device may not cause harmful interference, and
- (2) this device must accept any interference received, including interference that may cause undesired operation.

**NOTE: Before using the remote control system for the first time,** the receiver and the handset must be synchronized. See the section *Synchronize Remote Control* on page 26.

**IMPORTANT: BEFORE YOU BEGIN,** please note that on this system, the settings of time, temperature and automatic ON/OFF **can only be programmed when the function display is flashing.** Be patient when programming as it can take a few seconds to set.

Note: In the TEMP or TIMER modes, the remote handset senses the room temperature and adjusts the flame accordingly.

To communicate, the handset should be within 15 feet (4.5 meters) of the fireplace.

**Do not leave the handset on the mantel or hearth.**

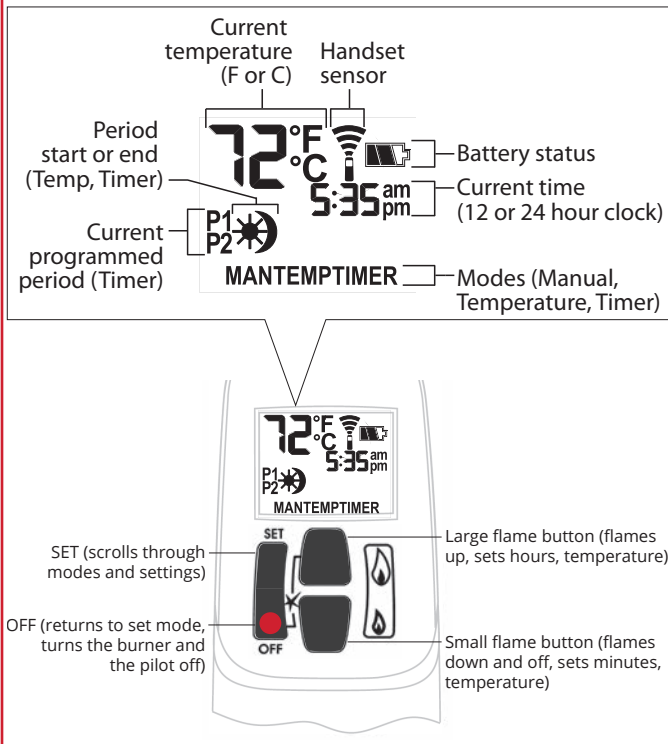

## Turn Fireplace ON

Press ● + 🔥 buttons until you hear a short beep; release buttons.

Beeping continues until pilot is lit.

Burner lights to maximum flame height and handset goes automatically to manual (MAN) mode.

NOTES:

On the valve, MAN button must be at ON, in full counter-clockwise position .

ON/OFF switch (if equipped) must be in I (ON) position.

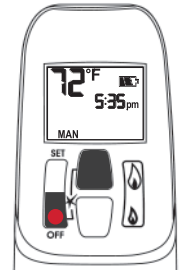

## Turn Fireplace OFF

Press ● button.

When pilot is just turned off, wait 2 minutes to light it again.

## Standby Mode (Pilot Flame)

Press and hold 🔥 to set fireplace to pilot.

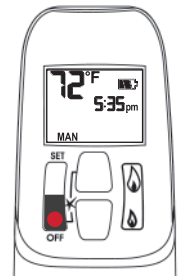

## Adjust Flames Height

With pilot lit, press and hold buttons:

🔥 = increase flame height

🔥 = decrease flame height or set to pilot

For fine adjustment, tap buttons.

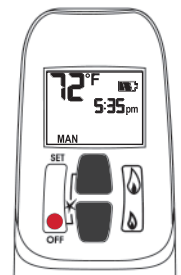

## Express Low and High Fire

Double-click buttons:

🔥 = increase flame to maximum height "HI"

🔥 = decrease flame minimum height "LO"

NOTE: Flame goes to high fire first before going to designated low fire.

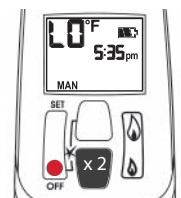
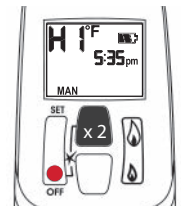

# Appendix B—Remote Control Operation

## Setting °C/24-hr or °F/12-hr clock

In MAN mode, press and hold ● + 🔥 buttons until temperature / clock display changes from

°F / 12-hour ↔ °C / 24-hour

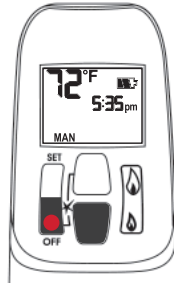

## MAN Manual Mode

Manual flame height adjustment.



## Setting Time

The time display will flash after either:

- installing the battery, or
- pressing 🔥 + 🔥

To set the time, press buttons:

🔥 = hour

🔥 = minutes

Press ● or wait to go back to MAN.

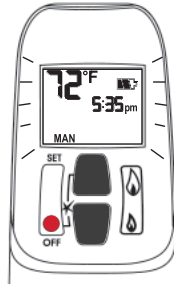

## ☀️ TEMP Daytime Temperature Mode

When pilot is lit, room temperature is measured and compared to set temperature. Flame height automatically adjusts to reach Daytime Set Temperature.



## 🌙 TEMP Night time Setback Temperature Mode

When pilot is lit, room temperature is measured and compared to set temperature. Flame height automatically adjusts to reach Night Time Setback Temperature.

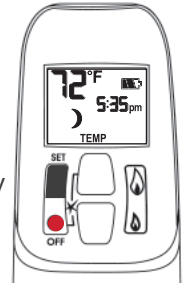

## TIMER Timer Mode

When pilot is lit, two periods of time (P1 and P2) can be programmed to use Daytime and Night time temperatures at specific times.

Note: Display shows set temperature every 30 seconds.

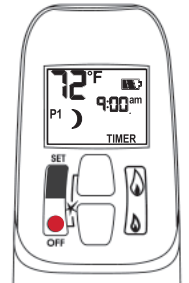

## Modes of Operation

Briefly pressing SET cycles through modes of operation.

MAN > ☀️ TEMP > 🌙 TEMP > TIMER > MAN

NOTE: Press 🔥 or 🔥 to reach MAN mode.

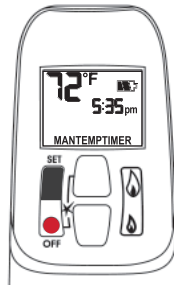

Set the different parameters when they are flashing.

# Appendix B—Remote Control Operation

## Setting high / low Temperatures

### Setting “DAYTIME” high temperature.

Default Settings:  TEMP 23 °C/74 °F

Press SET to scroll to  TEMP

Hold SET button until TEMP flashes.

To set  Daytime Temperature:

 = increases temperature.

 = decreases temperature.

Press  or wait to complete setting.

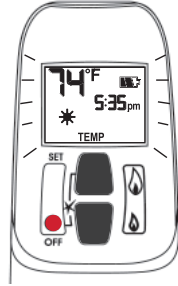

### Setting “NIGHT TIME SETBACK” low temperature.

Default Settings:  TEMP “-” (OFF)

Press SET to scroll to  TEMP

Hold SET button until TEMP flashes.

To set  Night Time Temperature:

 = increases temperature.



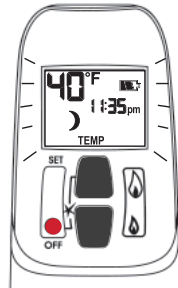

 = decreases temperature.

Press  or wait to complete setting.



## Setting Program Timers



You can program two periods of time between 12 am and 11:50 pm in each 24-hour cycle.



Programs P1 and P2 must be set in the following order during a 24-hour cycle: **P1** , **P1** , **P2**  and **P2** .

 = Day Time temperature (high) program period

 = Night Time temperature (low) program period





### Default Settings:



Program 1: **P1**  06:00 am **P1**  08:00 am





Program 2: **P2**  11:50 pm **P2**  11:50 pm

Press SET to scroll to .



If **P1**  = **P1**  or **P2**  = **P2** , programming is cancelled.

To keep fireplace ON all night, set **P2**  at 11:50 am and **P1**  at 12:00 am.

If you want to program only one period, program **P1**  and **P1**  with desired times then **P2**  and **P2**  with the same time as **P1** .

### Setting P1 time—high temperature.

Hold SET button until **P1**  is displayed and time flashes.

To set time:

 = hour

 = minutes

Press  or wait to complete setting.

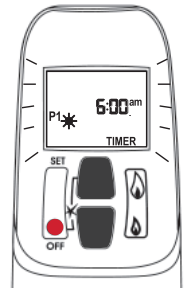

### Setting P1 time—low temperature.

Hold SET button until **P1**  is displayed and time flashes.

To set time:

 = hour

 = minutes

Press  or wait to complete setting.

# Appendix B—Remote Control Operation

## Setting P2 high and low temperature times.

Repeat same steps as Setting P1.

When all settings are complete, press ● to save them.

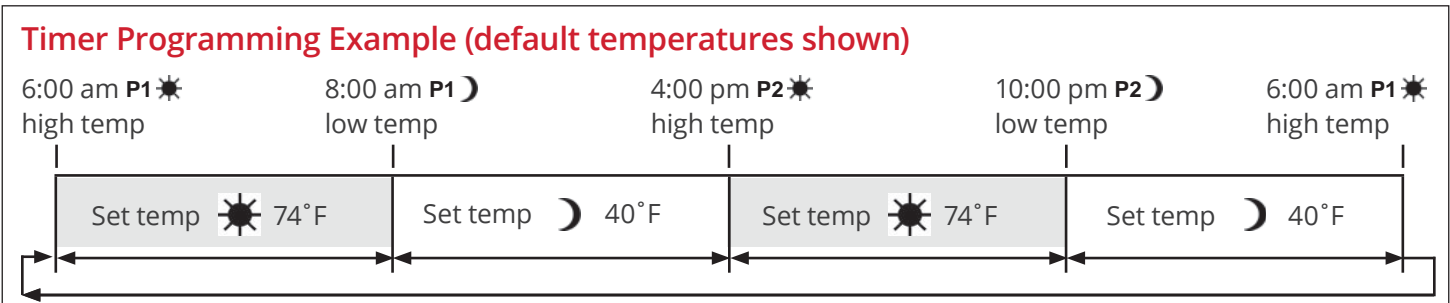

## Automatic Turn Down

### 8-Hour no Motor Movement

The valve will turn to pilot flame if there is no motor movement for an 8-hour period.

## Automatic Shut-Off

**Low Batteries Receiver.** With low battery power in the battery holder the system shuts off the fire completely. This does not apply when the power supply is interrupted.

**On-Demand Pilot (7 Day Shut-Off).** This green feature eliminates gas energy consumption during extended appliance inactivity. When the appliance is inactive for an extended period of time the system automatically extinguishes the pilot. This feature helps the consumer realize cost benefits by automatically eliminating energy consumption during non-heating months and limited use.

The programmed length of inactivity to activate the system is specified by the appliance manufacturer and cannot be altered in the field.

## Low Battery Indication

### ⚠ Caution

**DO NOT USE** a screwdriver or other metallic object to remove batteries from holder. This could cause a short-circuit.

**Handset:** The battery icon  will show when the battery needs to be replaced. Replace with one 9 V **alkaline** battery.

**Battery holder:** Frequent 'beeps' for 3 seconds when the valve motor turns indicate the batteries need to be replaced in battery holder. Replace with four 1.5 V **alkaline** batteries.

## Handset / Receiver Match

The remote control handset and receiver are programmed to function together. In case of a replacement of the handset or the receiver, you will need to reset the receiver to allow them to function together. Contact your dealer for details.

# Appendix C—Spare Parts

	Description	Part Number
1	Exhaust Slide Assembly	4000127
1a	2.5-4.5" hose clamp	4000768
2	Port Cover	4001820AH
3	Fuel Bed Support	4006177
3a	Support Bracket - Log	4009301
4	Side Bricks Anchors (2)	4001283
5	Top Mounting Bracket	4000136AZ
6	Side Mounting Brackets (2)	4000135AZ
7	Window Assembly	4001378
7a	Hot glass warning plate	4003093
8	Burner Assembly (natural gas)	4007450
	Burner Assembly (propane gas)	4007451
9	Burner Rail (natural gas)	4001665
	Burner Rail (propane gas)	4001666
10	Injector Elbow (natural gas)	9730012
	Injector Elbow (propane gas)	9730007
11	Air Shutter Cover (natural gas)	4002346
11a	Air Shutter Slider (natural gas)	4002345
12	Flashback Shield (propane gas)	3000371
12a	Air Shutter Slider (propane gas)	320B293
13	Burner Baffle	4001784
14	Burner Mounts (2)	4001678
15	Pilot Shield	4000144
16	Pilot Assembly (natural gas)	4007220S
	Pilot Assembly (propane gas)	4007221S
17	Pilot Bracket	720A542
18	Pilot Injector #35 (natural gas)	4002511
	Pilot Injector #27 (propane gas)	720A195
19	Hooked Olive for Pilot Injector	720A196
20	Olive Nut for Pilot Pipe	420K385
21	Electrode	4001856
22	Electrode Retaining Nut	4001855
23	Thermocouple	4000061
24	Pilot Mount	4000138
25	Pipe—Valve to Main Burner (incl. olive & nuts)	4000065
26	Burner Tray	4001677
27	Burner Plate Access Panel	4001681
28	Olive Nut for Pilot Pipe	220K913
29	Pipe—Valve to Pilot	4001838
30	Valve Mounting Bracket	4000141
31	Thermocurrent Interruptor	4001037

	Description	Part Number
32	GV60 Valve Assembly (natural gas)	4007440X
	GV60 Valve Assembly (propane gas)	4007441X
33	Cable interrupter-receiver (yellow)	4002096
34	Ignition Cable 500 mm	4001039
35	Ignition Cable Sleeve	4002244
36	Receiver PLUS	4001911
37	Wiring Harness	4001187
38	Vent Safety Switch Assembly	4007429
39	Handset PLUS	4001910
40	Handset Wall Holder	9000008
41	Auxiliary battery holder	4006553
42	Battery holder cable 1500 mm	4006552
43	GV60 Valve Repair Kit, not included	4004544
44	Liner Set Complete	
	Fluted Black	739FBL
	Valor Red Brick	739VRL
45	Rear Panel	
	Reflective Glass	739RGL
46	Left Panel	
	Fluted Black	4001814
	Valor Red Brick	4001811
46a	Right Panel	
	Reflective Glass	4005017
47	Filler Panel	4005018
	Fluted Black	4001812
	Valor Red Brick	4001809
47a	Right Panel	
	Reflective Glass	4005015
48	Side Spacers (4)	4005016
	Fluted Black	4001813
	Valor Red Brick	4001810
48a	Rock Set Complete	4005016
	Fluted Black	4001813
	Valor Red Brick	4001810
49	Rock No. 1	4001821
	Rock No. 2	4001822
	Rock No. 3	4001823
50	Rock No. 4	4001824
	Rock No. 5	4001825
	Rock No. 6	4001826
51	Rock Base	4001792
	LH Twig	4001827

# Appendix C—Spare Parts

	Description	Part Number
57	RH Twig	4001828
58	Glass Panel	4001836
59	Front Support—Platform	4001835BY
60	Ceramic Platform	4001832
61	Driftwood Kit	739DWK
62	Rear Log	4005615
63	Base Log	4005617
64	RH Cross Log	4005616
65	Front Log	4005817
66	LH Cross Log	4005618
67	Small Beige Beach Pebble (3)	4003087
68	Small Grey Beach Pebble	4003086
69	Brown Beach Pebble	4003082
70	Grey Beach Pebble	4003083
71	Platform	4005619
72	Traditional Log Set Complete	739TLK
73	Base Panel	4008849
74	Log G30	4008844
75	Log G31	4008845
76	Log G32	4008846
77	Log G33	4008847
78	Log G34	4008848
79	Embers (3)	4008850
80	Legend Traditional Log Set Complete	739LSK
81	Rear Log	4003787
82	LH Top Log	4003788
83	RH Top Log	4003789
84	RH Center Log	4003790
85	LH Front Log	4003792
86	RH Front Log	4003793
87	Loose Coals	4001843

# Appendix C—Spare Parts

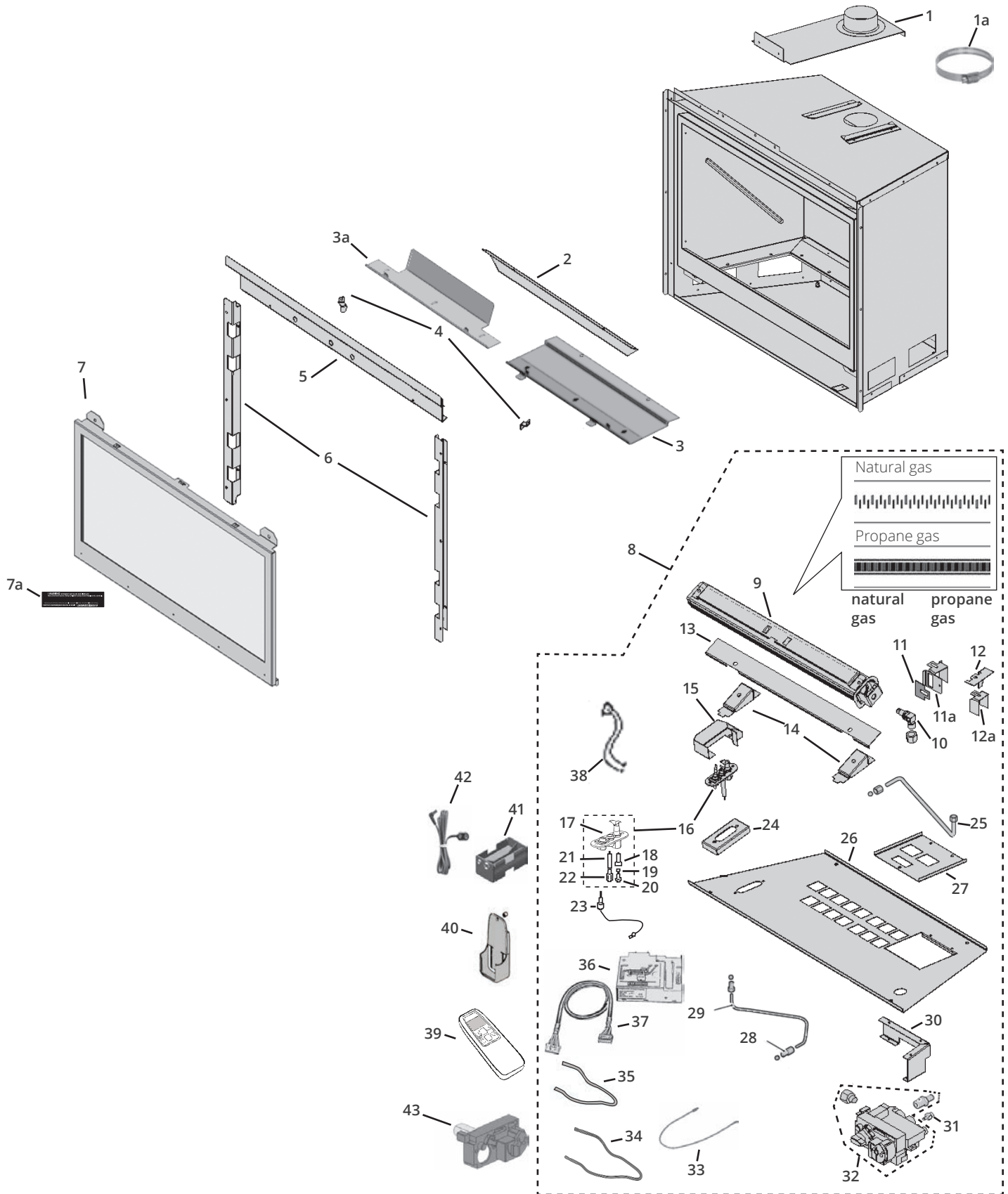



# Appendix C—Spare Parts

