

H3

Gas Fireplace
natural gas 1000KN
propane gas 1000KP



⚠ WARNING:
FIRE OR EXPLOSION HAZARD
Failure to follow safety warnings exactly could result in serious injury, death, or property damage.

Do not store or use gasoline or other flammable vapors and liquids in the vicinity of this or any other appliance.

WHAT TO DO IF YOU SMELL GAS

- Do not try to light any appliance.

- Do not touch any electrical switch; do not use any phone in your building.
- Leave the building immediately.
- Immediately call your gas supplier from a neighbor's phone. Follow the gas supplier's instructions.
- If you cannot reach your gas supplier, call the fire department.

Installation and service must be performed by a qualified installer, service agency or the gas supplier.

DANGER



Hot glass will cause burns.

Do not touch glass until cooled.

Never allow children to touch glass.

A barrier designed to reduce the risk of burns from the hot viewing glass is provided with this appliance and must be installed for the protection of children and other at-risk individuals.

This appliance may be installed in an after-market permanently located, manufactured (mobile) home where not prohibited by local codes. This appliance is only for use with the type of gas indicated on the rating plate. This appliance is not convertible for use with other gases, unless a certified kit is used.

INSTALLER: Leave this manual with the appliance.

CONSUMER: Retain this manual for future reference.

Massachusetts:

The piping and final gas connection must be performed by a licensed plumber or gas fitter in the State of Massachusetts. Also, see Carbon Monoxide Detector requirements in the fireplace installation manual.

⚠ WARNING

This product can expose you to chemicals including Benzene, which is known to the State of California to cause cancer and birth defects or other reproductive harm.

For more information go to www.P65Warnings.ca.gov.

Note: Natural gas, in its original state, contains Benzene.



We recommend a US Certified National Fireplace Institute (NFI) specialist install our gas hearth products.

The information contained in this manual is believed to be correct at the time of printing. Miles Industries Ltd. reserves the right to change or modify any information or specifications without notice. Miles Industries Ltd. grants no warranty, implied or stated, for the installation or maintenance of your heater, and assumes no responsibility for any consequential damage(s).

© Copyright Miles Industries Ltd., 2022. All rights reserved.
Designed and manufactured for Miles Industries Ltd.

Welcome to Valor®

Thank you for purchasing a **Valor Fireplace**. We appreciate your business and wish you many happy years enjoying your new fireplace.

Your new radiant gas heater is a technical appliance that must be installed by a qualified dealer. Each Valor® fireplace is fully tested during the production process for your safety and comfort.

Your unit has been professionally installed by:

Dealer Name: _____

Phone: _____

If you experience any problems, call your dealer immediately. Do not try to repair the unit as you may cause an injury or damage the fireplace.

Your Valor Fireplace

Here are some important details about your Valor fireplace, should you need to contact your dealer.

Model: 1000 KN (natural gas) or KP (propane)

Serial: _____

Trim: _____

Options: _____

Please ask your installer for these details if they are not already provided, or see page 7.

Important—Register your warranty

You should register your Valor using the enclosed Warranty Registration card. This enables us to properly address any warranty or service related concerns you may have.

We do not use this information in any way other than customer service and warranty purposes. It is never shared with any third party.

If you would prefer to register online, it's fast and easy to do so at valorfireplaces.com/warranty.

Homeowner: Please read this manual before operating this appliance, and save for future reference.

Contents

Safety and your fireplace	4
Child safety and your fireplace.....	6
Getting started.....	7
First time operation.....	7
Locating fireplace and lighting information.....	7
Parts of your fireplace.....	8
Operating your fireplace	9
Fireplace control devices.....	9
Preventing inadvertent ignition	10
Replacing batteries.....	11
Annual service and maintenance.....	12
Cleaning your fireplace	13
Checking pilot and burner flames.....	17
Frequently asked questions.....	18
Valor® Warranty	20
Valor® Outdoor Installation Warranty.....	21
Appendix A - Remote Control Operation	22
Appendix B - Wall Switch Operation.....	26

Valor Fireplaces

190-2255 Dollarton Highway
North Vancouver, BC, Canada V7H 3B1
T 604.984.3496 F 604.984.0246
valorfireplaces.com

Safety and your fireplace

This manual contains very important information about the safe operation of your fireplace, as well as maintenance instructions. Read and understand all instructions carefully before operating your fireplace. Failure to follow these instructions may result in possible fire hazard and will void the warranty.

Replacement manuals are available by contacting the Valor Customer Service at 1-800-468-2567, or by visiting valorfireplaces.com.

WARNING: Extremely Hot!

Heat and flammability

- Some parts of your fireplace are extremely hot, particularly the glass window. Use the barrier screen provided with the trim or a gate to reduce the risk of severe burns.
- Due to its high temperature, the appliance should be located out of traffic areas and away from furniture and draperies.
- Clothing or flammable material should not be placed on or near the appliance.
- Always keep the appliance clear and free from combustible materials, gasoline, and other flammable vapors and liquids.
- Be aware of hot wall surfaces! The wall directly above the fireplace can get very hot when the fireplace heats. Although safe, it may reach temperatures in excess of 200° F depending on choice of trims or optional accessories. Do not touch!
- Be aware of hot hearth/floor surfaces! The hearth or floor directly in front of the fireplace can get very hot when the fireplace heats. Although safe, they may reach temperatures in excess of 200° F depending on elevation of hearth. Do not step on it! Temperature of hearth/floor surface will be reduced when barrier screen is installed.
- Solid wood flooring in front of the fireplace (if allowed) may shrink during the heating season due to heat.
- Some materials or items, although safe, may discolor, shrink, warp, crack, peel, and so on because of the heat produced by the fireplace. Avoid placing candles, paintings, photos and other combustible objects sensitive to heat or furniture within 36 inches (0.9 m) around the fireplace.

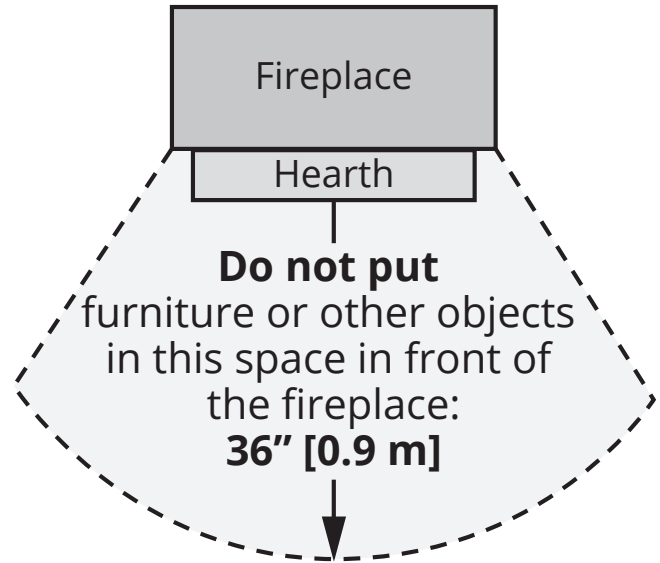

Glass window

WARNING

Do not operate this appliance with the glass front removed, cracked, or broken. Replacement of the glass front should be performed by a licensed or qualified service person. Do not strike or slam the glass front.

- The glass front assembly must be in place and sealed before the unit can be placed into safe operation.
- The glass front assembly must only be replaced as a complete unit, as supplied by the fireplace manufacturer. No substitute material may be used.
- Do not use abrasive cleaners on the glass front assembly. Do not attempt to clean the glass front when it is hot.

Safety and your fireplace

Barriers and safety

- A barrier designed to reduce the risk of burns from the hot viewing glass is provided with this appliance and must be installed for the protection of children and other at-risk individuals.
- If the barrier becomes damaged, the barrier must be replaced with the manufacturer's barrier for this appliance.
- Any safety screen, guard or barrier removed for servicing the appliance must be replaced prior to operating the appliance.
- The appliance and venting system should be inspected before initial use and at least annually by a professional service person.

Initial and annual inspection

- Installation and repair should be performed by a qualified service person.
- If any part of this fireplace has been under water, immediately call a qualified service technician to inspect the unit and to replace any part of the control system and any gas control that has been under water.

Intended use

- This appliance is designed and approved as a supplemental heater and provides the potential for most energy conservation when used while attended. The use of an alternate primary heat source is advisable.

Maintenance

- Clean frequently if excessive lint from carpeting, bedding, etc., exists.
- Keep the unit's control compartment, burner, and circulating air passageways clean to provide for adequate combustion and ventilation air.
- Inspect the external vent cap on a regular basis to make sure that no debris, plants, trees, shrubs are interfering with the air flow.

Venting

- Never obstruct the flow of combustion and ventilation air. Keep the front of the appliance clear of all obstacles and materials for servicing and proper operation.
- This gas fireplace and vent assembly must be vented directly to the outside and must never be attached to a chimney serving a separate solid fuel burning appliance. Each gas appliance must use a separate vent system. Common vent systems are prohibited.

WARNING

Front outlet

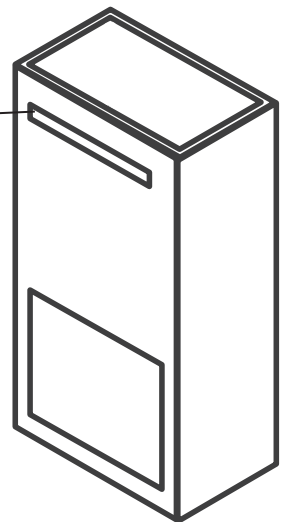

**Optional HeatShift:
Do not cover or
place items in front
of outlet!**

Child safety and your fireplace

DANGER



Hot glass will cause burns.

Do not touch glass until cooled.

Never allow children to touch glass.

A barrier designed to reduce the risk of burns from the hot viewing glass is provided with this appliance and must be installed for the protection of children and other at-risk individuals.

A heating gas appliance does require safe handling. For this reason, we very strongly recommend children not be allowed to touch the fireplace or its controls.

Read and carefully follow all safety warnings and operating instructions contained in this manual, and follow these important child safety precautions and recommendations:

- Parts of your Valor Fireplace become extremely hot while in operation. The glass viewing window temperature can exceed 500° F at full capacity.
- Do not let children touch the glass or any parts of your fireplace even after it is turned off, as the surfaces will remain hot for some time.
- Momentary contact with a hot glass surface can cause a severe burn, even if the fireplace is operating at reduced heating capacity.
- The glass window will remain hot for an extended period of time after the fireplace has been turned off. Make sure that children are prevented from touching the fireplace during the cool down period.
- Children and adults should be alerted to the hazards of high surface temperature and should stay away to avoid burns or clothing ignition.
- Toddlers and young children must be closely supervised at all times when they are in the same room as the operating fireplace. They lack full awareness of danger and rely on your protection. Toddlers, in particular, do not have the motor skills and response reflexes to withdraw in the event of accidental contact with a hot surface.
- A physical barrier is strongly recommended if there are young children, or at-risk individuals in the house. Install an approved after-market safety gate to keep toddlers, young children and other at-risk individuals a safe distance from the fireplace.
- Keep the remote control handset out of reach of children at all times. A wall mount storage support is provided with your remote control handset.
- Make sure that the fireplace, including the pilot light, is completely turned off when children are present and close supervision and safety barriers are not available—see pages 9–10 of this manual.
- If the fireplace is not going to be used for the summer or any extended period of time, remove the batteries from the remote control handset and battery holder under the firebox. It is recommended that batteries are replaced annually in any event—see page 11 of this manual.

Getting started

First time operation

When operating your new fireplace for the first time, some vapors may be released due to the burning of curing compounds used in the manufacture of the fireplace. They may cause a slight odor and could cause the flames to be the full height of the firebox, or even slightly higher, for the first few hours of operation.

It is also possible that these vapors could set off any smoke detection alarms in the immediate vicinity. These vapors are quite normal on new fireplaces. We recommend opening a window to vent the room. After a few hours use, the vapors will have disappeared and the flames will be at their normal height.

Valor automatic gas shut-off

For your safety, this fireplace is fitted with a flame supervision device which will shut-off the gas supply if, for any reason, the pilot flame goes out. This device incorporates a fixed probe, which senses the heat from the pilot flame. If the probe is cool, the device will prevent any gas flow unless manually lighting the pilot. See full lighting instructions card attached to the fireplace or reproduced in Appendix A of the fireplace's Installation manual.

Locating fireplace and lighting information

The Fireplace and Lighting Information card is located on a card at the right hand side of the fireplace case. To access the card, remove the barrier screen and side door. Grab the card and pull it out. There is important information on both sides of the card.



WARNING

Do not attempt to access the card while the fireplace is hot! Let the fireplace cool first before touching it!

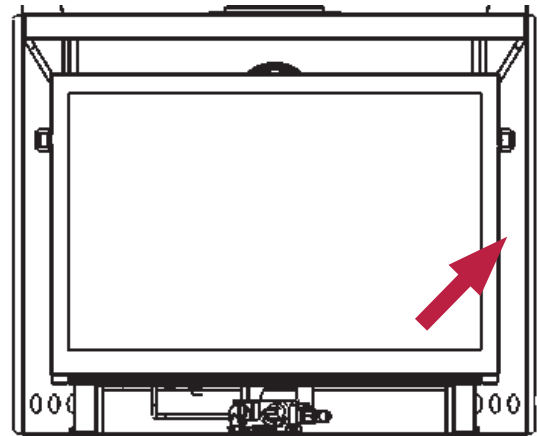

Fireplace model
Serial number

VALOR INDUSTRIES INC. 10000 VALLEY VIEW RD. CANADA		Max 25,000 Btu/h
MODEL/MODELE 1000JN		Net Capacity (Min) 12,000 Btu/h
FOR NATURAL GAS		Gas Pressure (psi) 3.2"
1000N2001		Gas Pressure (kPa) 5.0"
1000N2001		Gas Pressure (mmHg) 750

72% EFFICIENCY

Valor

Parts of your fireplace

Here are the major components of your installed fireplace, both with and without the protective barriers installed. Your individual fireplace may appear slightly different depending on your installed options.

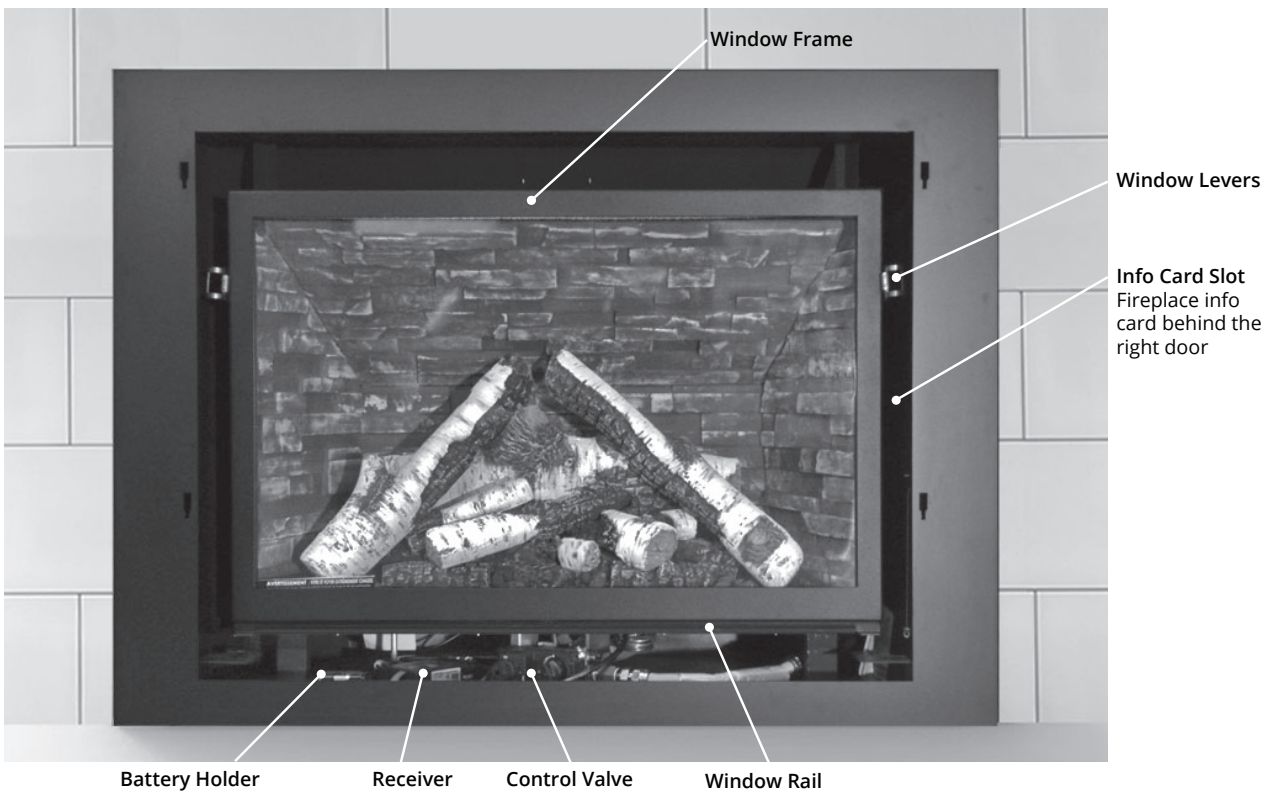
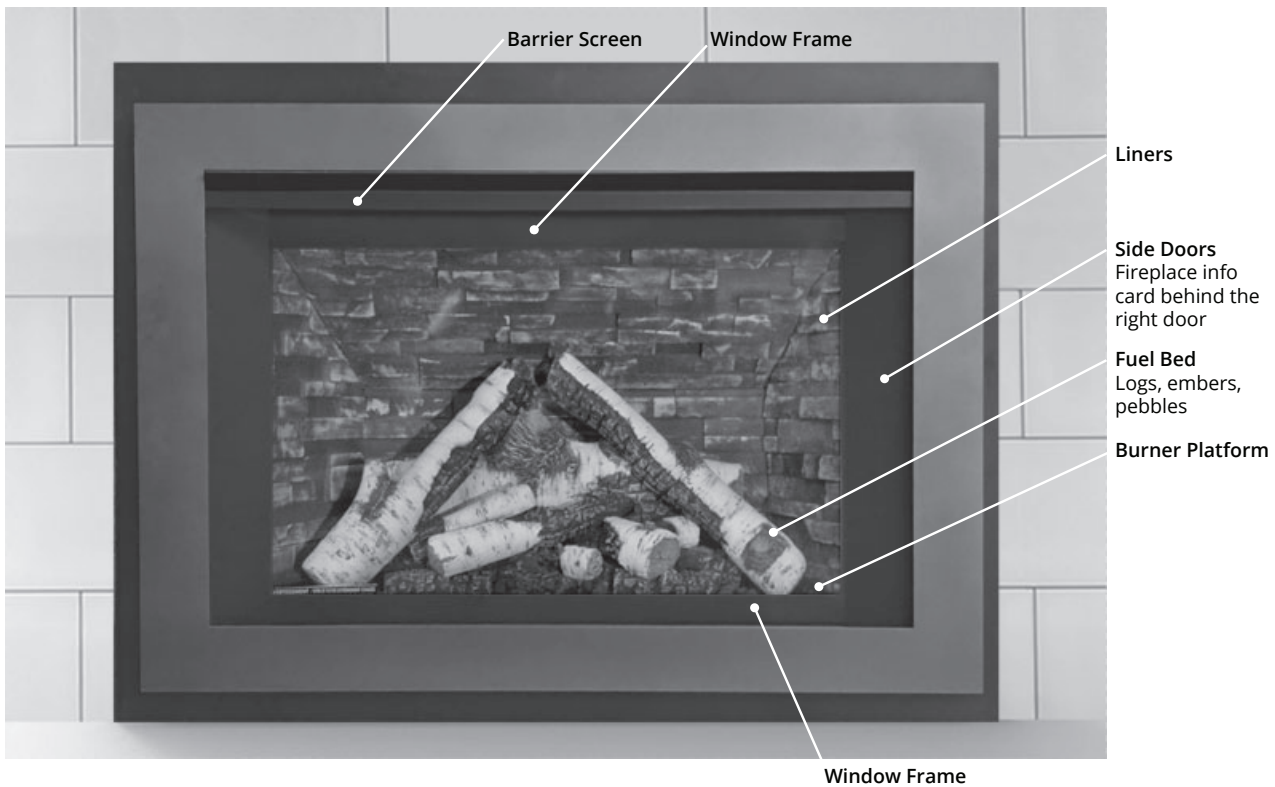

Operating your fireplace

Fireplace control devices

There are two ways to control your fireplace.

1. Thermostatic Remote Control turns fire ON, OFF, controls flame height and can be programmed to function automatically—see *Appendix A - Remote Control Operation* on pages 22–25.
2. Wall Switch turns fire ON, OFF and controls flame height—see *Appendix B - Wall Switch Operation* on page 26.

Remote Control



Wall Switch



Turn your fireplace ON

WARNING

STOP IF YOU SMELL GAS! DO NOT LIGHT!
See cover page immediately!

Press and hold:

- ● + 🔥 buttons on remote, or
 - ON-OFF button on wall switch
- until a short beep confirms the start sequence has begun; release buttons.

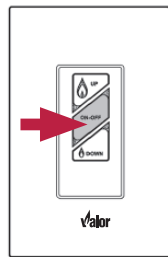
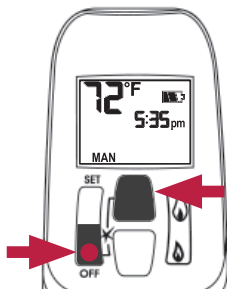

Continuing beeps confirm the ignition is in process. The pilot lights up, then the fireplace.

If you need to light up the pilot manually, see the Lighting Instructions card attached to the fireplace—see page 7 to know how to access it. Also, a copy of this card is reproduced in Appendix A of the fireplace Installation Manual.

Turn your fireplace OFF (including pilot)

Press and hold:

- ● button on remote, or
- ON-OFF button on wall switch

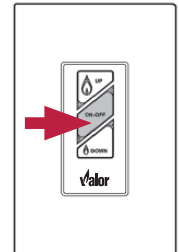
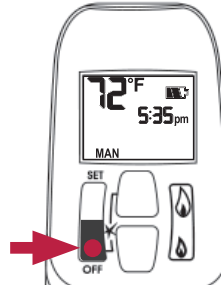

If the flames are on, they go down and you hear the valve motor wind down. You hear a clunk and a beep indicating that the valve has received the signal from the remote control.

In the unlikely event that you cannot turn off your fireplace with the remote control handset, use the wall switch; if the wall switch malfunctions and will not turn off the fireplace, wait 8 hours and the fireplace will automatically go to pilot. You can then access the controls inside your fireplace.

WARNING

Risk of severe burns! Surface of the fireplace are very hot during operation! Ensure fireplace has cooled off before accessing control.

Alternately, turn off your house gas supply. In all cases, call your dealer for service assistance.



ON:
parallel
to pipe



OFF:
perpendicular
to pipe



To use additional functions of your Remote Control such as temperature or program settings, visit valorfireplaces.com/remotes

Operating your fireplace

Preventing inadvertent ignition

You can use one of the two following methods to make sure that your fireplace will not turn on when you don't want it on.

- On gas valve, turn dial from ON position to MAN position as shown. Turning dial to MAN will make sure that main burner cannot come on. The pilot will remain on if lit.

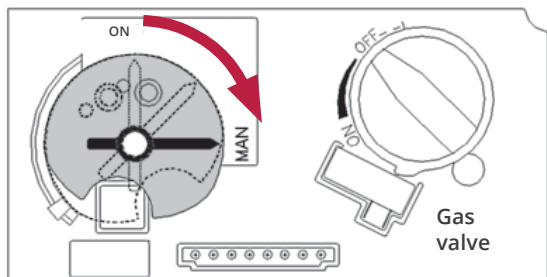

- Alternately, remove all batteries from the battery holder next to receiver as well as from the handset.

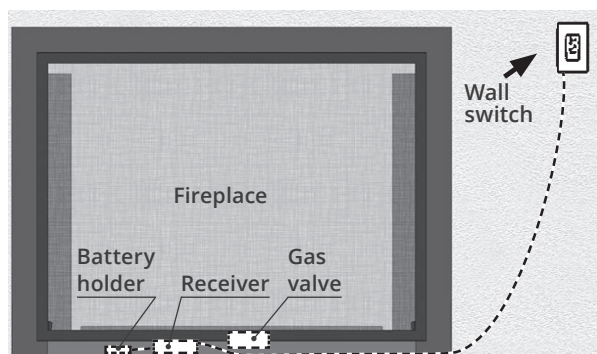

Battery holder located next to receiver on bottom of fireplace under removable panel.

Automatic shut-off (in certain conditions)

Your fireplace's remote control is equipped with an automatic shut-off mechanism which is activated in certain conditions. See *Remote Control* handbook or valorfireplaces.com/remotes for a description of this feature.

Replacing batteries

WARNING

Do not attempt to access the batteries while the fireplace is hot! Let the fireplace cool first before touching it!

Caution

Do not use a screwdriver or other metallic object to remove the batteries from the battery holder or the handset! This could cause a short circuit.

Low batteries signals:

- Handset: battery icon on display shows 1 lit bar
- Holder: frequent beeps for 3 seconds when valve motor turns.

BEFORE changing the batteries, turn the fireplace off (including pilot) and disconnect the battery holder from the receiver.

The fireplace uses four 1.5 V AA **alkaline** batteries in a separate battery holder located next to the receiver and one 9 V **alkaline** battery in its handset. Batteries should last one to two seasons, depending on usage. Removing the batteries in the off-season will extend the battery life.

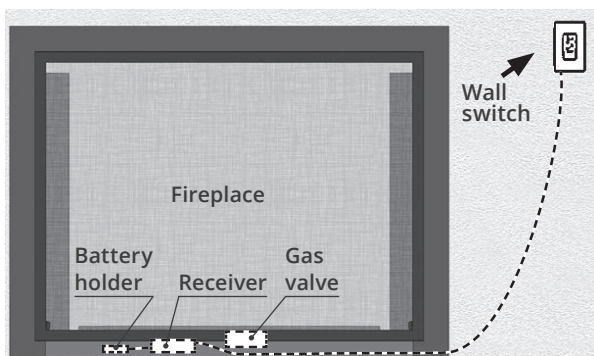

Battery holder located next to receiver on bottom of fireplace under removable panel.

To access the battery holder, unhook the barrier screen, lift up the side doors and pull them straight towards the center of the fireplace. Pull out the removable panel under the window frame.

To replace the batteries:

1. Remove the barrier screen by pulling on it or unhooking it depending on trim model.
2. Lift up the side doors then pull them straight out sideways towards the center of the fireplace.
3. Pull the removable panel straight out.
4. Locate the battery holder next to the receiver and pull it out.



Battery holder

5. Disconnect the battery holder connector. **Do not pull on the wire!**
6. Replace the batteries with 4 new AA **alkaline** batteries. Avoid using old/new batteries together.

Caution

Do not put batteries in the receiver as leaking acid could damage its circuit board.

7. Reconnect the battery holder to its wire.
8. Replace the holder to the left of the receiver.
9. Reinstall the removable panel, side doors and barrier screen.

Using Handset Wall Holder

Your fireplace equipment includes a wall holder to store the handset. If it hasn't been installed, refer to the instructions in the fireplace Installation Manual.



Remote and wall holder

Annual service and maintenance

We recommend having your fireplace serviced every year. Contact your dealer quoting the model number. It will be helpful if the fireplace's serial number can also be quoted. These numbers are on the information card (see page 7).

A list of replacement parts is included in your fireplace Installation Manual. Please always quote the part number and description when requesting spare parts.

Annual Inspection

Maintain the safe operation of your fireplace. Contact your dealer to have a qualified technician go over the list below and make the necessary verifications at least once every year.

Safe Operation List: to be performed by a qualified technician only.

- Inspect and operate the pressure relief mechanism to verify relief mechanisms are free from obstruction to operate. See *Cleaning Your Fireplace* section of this manual.
- Clean glass window with a suitable fireplace glass cleaner. Abrasive cleaners must not be used. Be careful not to scratch the glass when cleaning. See *Cleaning Your Fireplace* section of this manual.
- Inspect the operation of the flame safety system Pilot or Flame rectification device.
- Inspect and make sure the lighting of the main burner occurs within 4 seconds of the main gas valve opening. Visual inspection should match that outlined in the appliance instruction manual. Inspect primary air openings for blockage. See *Checking Pilot and Burner Flame* section of this manual.
- Inspect condition of vent and vent terminal for sooting or obstruction and correct if present.
- Vacuum and clean any excess debris in the firebox that is not supposed to be there.
- Test and measure the flame failure response time of the flame safety system. It must de-energize the safety shutoff in no more than 30 seconds.
- Check all accessible gas-carrying tubes, connections, pipes and other components for leaks. See *Set up Gas Supply* section of the fireplace Installation Manual.



Caution

Label all wires prior to disconnection when servicing controls. Wiring errors can cause improper and dangerous operation.

Verify proper operation after servicing.

Cleaning your fireplace

WARNING

Risk of severe burns! Do not touch the glass while it is hot! Let the fireplace cool first before cleaning it.

Remove the window for cleaning

1. Remove the barrier screen by pulling on it if magnetized or unhooking it if hooked.
2. Remove the side panels by lifting them, then pulling them sideways towards the center, sliding them out of their slots behind the trim face.
3. Locate the levers on each side of the window towards the top. Using your finger, pull the levers towards you and unhook them from the window frame brackets.
4. Gently pull the top of the window outward.
5. Lift the window out of its bottom railing and set it aside in a safe place to avoid damage.

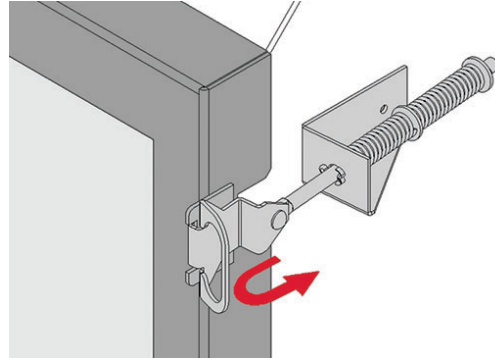
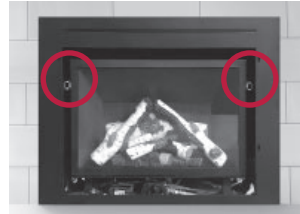

Spring Loaded Window Levers

Cleaning your fireplace

Cleaning glass mineral deposits

One of the by-products of the combustion process in a gas fireplace is a mineral which can show up as a white film on the ceramic glass window.

The composition of the deposit varies with location and time, therefore can appear intermittently.

There is no definitive solution to this issue. Various cleaning products have been tried with varying results. The following are recommendations only and are not meant to guarantee results.

Note: Mineral deposits occur naturally and are not covered under the Valor® warranty.

- Clean the glass regularly as soon as you notice the buildup (white film). If the film is left for a longer period of time, it will etch into the glass. It is then much harder, if not impossible, to remove.
- Never use an abrasive cleaner or ammonia-based cleaner on the ceramic glass. Any abrasion of the surface has the immediate effect of compromising the strength of the glass. An emulsion type cleaner is recommended.
- Use a soft damp cloth to apply the cleaner. Dry the glass with a soft, dry, preferably cotton cloth. Most paper towels and synthetic materials are abrasive to ceramic glass and should be avoided.
- Our dealers have had good results from the products listed below. We cannot, however, guarantee the results of these products.
 - » Brasso, Polish Plus by KelKem, Cook Top Clean Creme by Elco, White Off by Rutland, Turtle Wax

Do not clean the glass while it is hot.

- Always securely replace the window and the barrier screen before lighting.
- If broken, the glass pane may only be replaced as a complete window unit as supplied by the manufacturer.

- If the barrier screen becomes damaged, it must be replaced with the same model and version barrier from Valor.
- Clean the steel trims with mild soap and warm water. Any alcohol/solvent base cleaner will weaken the coating and damage it.
- Clean the barrier screens by dusting with a soft brush.
- Clean the firebox ceramic logs/rocks and walls by dusting them with a soft brush. Dust can also be removed from the burner using a soft brush after removing the ceramic logs. When cleaning, make sure that no particles are brushed into the slots of the burner.



Caution

Choking Hazard! Make sure the fireplace area is clear of firebed small particles to avoid ingestion by small children. Vacuum thoroughly around the fireplace area after cleaning.

Log position

Log position is important in your Valor fireplace. Proper log positioning optimizes the beauty of the flame and the combustion efficiency of your fireplace.

If the logs become disturbed during glass cleaning or other maintenance, refer to your fireplace Installation manual for the specific instructions on how to replace them for optimal operation.

Cleaning your fireplace

Refit the window

1. Place the window in its bottom railing. Make sure to remove any vermiculite or glass particles in the railing before installing the window.

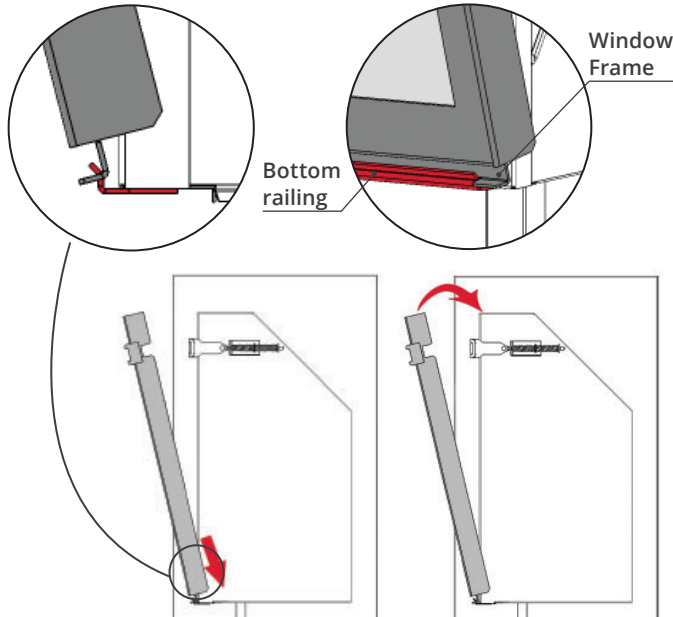

2. Push the top of the window frame against the firebox.
3. While you hold it, pull and hook the side levers back to the window brackets on each side.

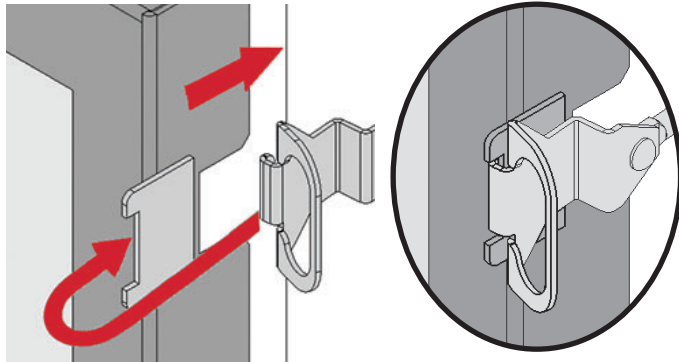

4. Apply firm hand pressure around the window frame to make sure the window is sealed tight against the firebox.

WARNING

The window unit must be correctly installed, fastened and sealed after servicing or serious bodily injury and/or damage to the fireplace may result.

To ensure a safe operation:

- Double-check that the bottom of the window frame is correctly installed in the bottom support railing;
- Verify that the levers are hooked properly to the window tabs then;
- Pull out the top of the window and release it to ensure the springs return it;
- Ensure the window is sealed before operation.

WARNING

Failure to install the window correctly can:

- Cause carbon monoxide to leak.
- Affect the performance of the fireplace.
- Damage components.
- Cause overheating resulting in dangerous conditions.

Damage caused by incorrect window installation is not covered by the Valor Warranty.

Cleaning your fireplace

5. If the Hot Glass Warning plate has been removed from the front lower corner of the window, re-install it by sliding it between the glass and the frame as indicated.

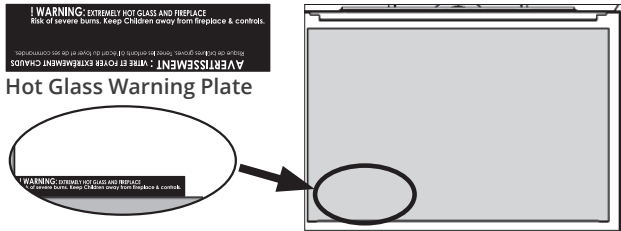

6. Re-install the side doors.
7. Re-install the barrier screen on the trim.

! WARNING

For safety purposes, make sure the barrier screen is re-installed on the fireplace front after maintenance.

Checking pilot and burner flames

A periodic check of the pilot and burner flames should be made. Check after the fire has been on for at least 30 minutes. The pilot flame must cover the tip of the thermocouple probe. The main burner flame pattern will vary from fireplace to fireplace depending on the type of installation and climatic conditions.

Performance of propane gas fireplaces may be affected by the quality of commercial gas supplied in your area.

The fireplace area must always be kept clear and free from combustible materials, gasoline and other flammable vapors and liquids.

Inspect the vent terminal outdoors regularly to make sure that snow, trees, bushes, leaves, or other objects do not obstruct it. We recommend at least an annual inspection.

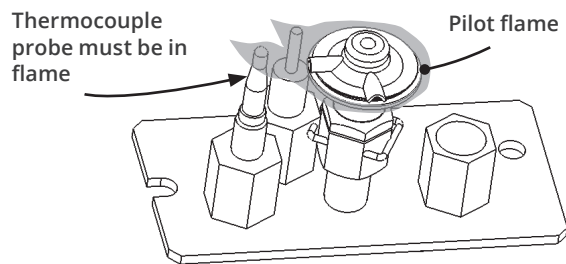

Note

The height and color of your flames can vary depending on fuel type, fuel quality and mixture, altitude, and aeration adjustment at or after installation.

The photos of typical flame appearance are for illustrative purposes only. Your fireplace may be operating normally but appear different than the photos.

Correct flame appearance



1000DWKV2—Driftwood



1000LSKV2—Traditional Logs

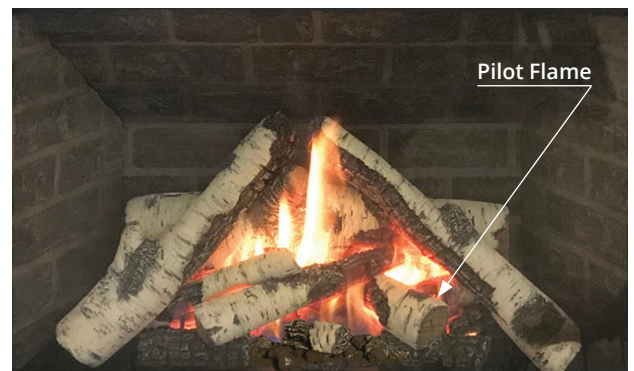

1000BLKV2—Birch Logs

Frequently asked questions

Question	Answer
What do I do if my fireplace won't turn on?	<p>If you have followed all instructions for your remote control or wall switch—see pages 9–10, or pages 22–26—and your fireplace still won't turn on, the batteries located inside the fireplace may be low and need replacing. See page 11 for instructions on how to replace the batteries.</p> <p>If the fireplace still won't turn on after that, call your dealer for further information. Your fireplace may require service by a qualified service technician. Visit valorfireplaces.com/contact for a list of dealers near you.</p>
I've just started my fireplace for the first time, what is that smell?	When first lit, your fireplace will burn some paint and oil residues left over from the manufacturing process. This is perfectly normal. See <i>First time operation</i> on page 7 more information.
When I operate the fireplace, why do I suddenly hear a faster series of beeps than usual?	This is an indication that the batteries in your fireplace are getting critically low (not the batteries in your remote control handset, but the batteries in the battery holder under your fireplace). See <i>Replacing batteries</i> on page 11 for instructions on how to replace the batteries.
Why do I hear popping or snapping noises?	As your fireplace heats and cools with normal use, its metal parts will expand and contract causing some noise. This is perfectly normal.
Why do I hear whirring noises?	As you start or adjust your fireplace's flame, the control valve motor turns to adjust the settings. This is perfectly normal.
How do I clean my fireplace?	Please see pages 13–16 for cleaning instructions to keep your fireplace looking great.
I dropped some pieces of embers under the fireplace while cleaning, is this dangerous?	No. The embers from the fuel bed are not flammable and will not impact the operation of your fireplace. Vacuum them up when you clean your fireplace.
There is condensation on the inside of the glass, is this okay?	This is normal, and will disappear naturally as the fireplace is turned on and heats up.

Frequently asked questions

Question	Answer
There is a white film on the inside of the glass, is this okay?	This happens due to composition of the gas from your supplier. Clean as soon as possible (when the fireplace is cool) so it does not bake onto the glass with time and become permanent. See pages 13–16 for cleaning instructions.
When I start my fireplace, the flame is blue or transparent, is this normal?	This is normal, your flame will take on a more yellow/orange appearance as the fireplace heats up.
When I start my fireplace, the flame is dirty or black, is this normal?	No. This is possibly caused by a blocked opening in the burner which can be cleaned by vacuuming it - see pages 13–16 for cleaning instructions. Call your dealer if the problem persists after cleaning.
Where can I purchase parts for my fireplace? Who can service my fireplace?	<p>Any of our Valor dealers are able to order parts or provide field service. Please contact your dealer—see page 3, or visit valorfireplaces.com/contact for a list of dealers near you.</p> <p>It will be useful to quote your model and serial numbers, which can be found on the fireplace information card attached to the fireplace—see page 7. Servicing must be performed by a qualified technician.</p>

Valor[®] Warranty

If you have a problem with this unit, please contact your dealer or supplier immediately. Under no circumstances should you attempt to service the unit in any way by yourself. The warranties in paragraphs 1 and 2 are provided only to the initial user of this unit, are not transferable and are subject to the conditions and limitations in paragraphs 3, 4 and 5. Please review the conditions and limitations carefully and strictly follow their requirements.

1. Extended Warranty Coverage

For a period of up to ten (10) years, Miles Industries Ltd., (the "Company") or its appointed distributor will at its option pay the initial owner for the repair of, or will exchange the following parts or components which are found to be defective in material or workmanship under normal conditions of use and service:

Maximum Warranty Period		10 years
Part or Component	Defect Covered	
Exterior steel casing	Corrosion	✓
Glass	Loss of structural integrity	✓
Cast iron parts	Corrosion	✓
Firebox and heat exchanger	Corrosion (but not discoloration) causing loss of structural integrity	✓

2. Two-Year Parts Warranty

In addition, for two (2) years from the date of purchase, the Company, at its option, will repair or exchange all parts and components not listed above but that are found to have a bona fide defect in material or workmanship under normal conditions of use.

3. Conditions and Limitations

- The warranty registration card must be completed by the initial owner and returned to the company within 90 days. Alternatively, the warranty registration form may be filled out online at www.valorfireplaces.com
- Installation and maintenance must be performed by an authorized and trained dealer in accordance with the Company's installation instructions.
- This warranty is void where installation of the unit does not conform to all applicable codes including national and local gas appliance installation codes and building and fire codes.
- The owner must comply with all operating instructions.
- The Company is not responsible for the labor costs to remove defective parts or re-install repaired or replacement parts.
- The initial owner of the unit will be responsible for any shipping charges for replacement parts as well as travel time incurred by the dealer to perform the warranty work.

- This warranty applies to non-commercial use and service and is void if it is apparent that there is abuse, misuse, alteration, improper installation, accident or lack of maintenance to the unit.
- The warranty does not cover damage to the unit through:
 - Improper installation, operational or environmental conditions.
 - Inadequate ventilation in the area or competition for air from other household equipment or appliances.
 - Chemicals, dampness, condensation, or sulphur in the fuel supply lines which exceeds industry standards.
- This warranty does not cover glass, log breakage or damage to the unit while in transit.
- The Company does not allow anyone to extend, alter or modify this warranty and assumes no responsibility for direct, indirect or consequential damages caused by the unit. State or provincial laws where the initial user or user resides may provide specific rights extending this warranty and, if so, the Company's sole obligation under this warranty is to provide labor and/or materials in accordance with those laws.

4. Discharge of Liability

After two (2) years from the date of purchase, the Company may, at its option, fully discharge all obligations under this warranty by paying to the first owner the wholesale price of, or replacing, any defective parts.

5. No Other Warranty

All obligations to repair this unit are defined in this warranty. Some states or provinces may specifically mandate additional obligations on the part of manufacturers, but in the absence of such specific legislation, there is no other warranty or obligation expressed or implied.

Valor® Outdoor Installation Warranty

If you have a problem with this unit, please contact your dealer or supplier immediately. Under no circumstances should you attempt to service the unit in any way by yourself. The warranties in paragraphs 1 are provided only to the initial owner of this unit, are not transferable and are subject to the conditions and limitations in paragraphs 2 and 3. Please review the conditions and limitations carefully and strictly follow their requirements.

1. Two-Year Parts Warranty

Two (2) years from the date of purchase, the Company, at its option, will repair or exchange all parts and components that are found to have a bona fide defect in material or workmanship under normal conditions of use.

2. Conditions and Limitations

- a) The warranty registration card must be completed by the initial owner and returned to the company within 90 days. Alternatively, the warranty registration form may be filled out online at valorfireplaces.com
- b) Installation and maintenance must be performed by an authorized and trained dealer in accordance with the Company's installation instructions.
- c) This warranty is void where installation of the unit does not conform to all applicable codes, including national and local gas appliance installation codes and building and fire codes.
- d) The owner must comply with all operating instructions.
- e) The Company is not responsible for the labor costs to remove defective parts or re-install repaired or replacement parts.
- f) The initial owner of the unit will be responsible for any shipping charges for replacement parts as well as travel time incurred by the dealer to perform the warranty work.
- g) This warranty applies to non-commercial use and service and is void if it is apparent that there is abuse, misuse, alteration, improper installation, accident or lack of maintenance to the unit.

- h) This warranty does not cover damage to the unit due to:
 - i) Improper installation, operational or environmental conditions.
 - ii) Inadequate ventilation in the area or competition for air from other household equipment or appliances.
 - iii) Damage due to chemicals, dampness, condensation, or sulphur in the fuel supply lines which exceeds industry standards.
- i) This warranty does not cover glass, log breakage or damage to the unit while in transit.
- j) The Company does not allow anyone to extend, alter or modify this warranty and assumes no responsibility for direct, indirect or consequential damages caused by the unit. State or provincial laws where the initial owner or user resides may provide specific rights extending this warranty and, if so, the Company's sole obligation under this warranty is to provide labor and/or materials in accordance with those laws.

3. No Other Warranty

All obligations to repair this unit are defined in this warranty. Some states or provinces may specifically mandate additional obligations on the part of manufacturers, but in the absence of such specific legislation, there is no other warranty or obligation expressed or implied.

Appendix A - Remote Control Operation

Radio Frequency

315 MHz for USA and Canada.

This device complies with Part 15 of the FCC Rules and with Industry Canada license-exempt RSS standard(s). Operation is subject to the following two conditions:
 (1) this device may not cause harmful interference, and
 (2) this device must accept any interference received, including interference that may cause undesired operation.

NOTE: Before using the remote control system for the first time, the receiver and the handset must be synchronized. See the section *Synchronize Remote Control* in the fireplace Installation Manual.

IMPORTANT: BEFORE YOU BEGIN, please note that on this system, the settings of time, temperature and automatic ON/OFF **can only be programmed when the function display is flashing.** Be patient when programming as it can take a few seconds to set.

Note: In the TEMP or TIMER modes, the remote handset senses the room temperature and adjusts the flame accordingly.

To communicate, the handset should be within 15 feet (4.5 meters) of the fireplace.

Do not leave the handset on the mantel or hearth.

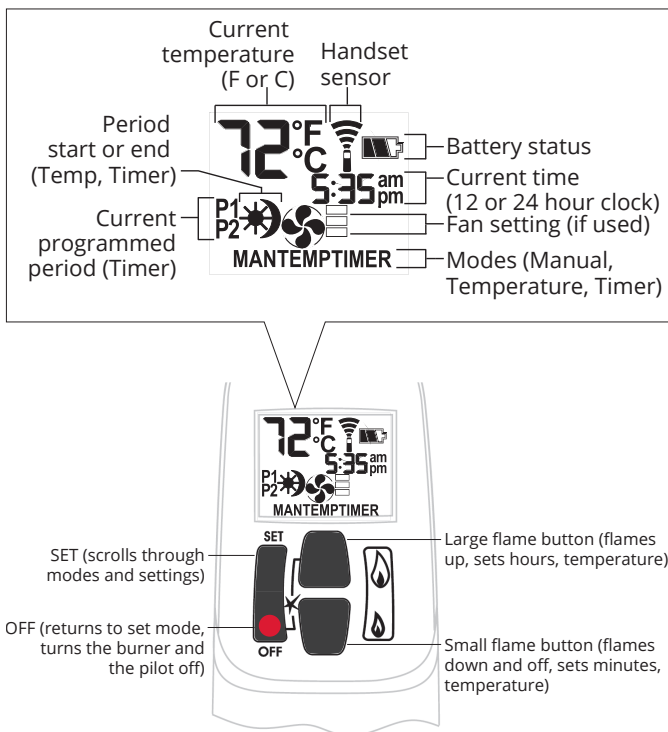

Turn Fireplace ON

Press ● + 🔥 buttons until you hear a short beep; release buttons.

Beeps continue until pilot is lit.

Burner lits to maximum flame height and handset goes automatically to manual (MAN) mode.

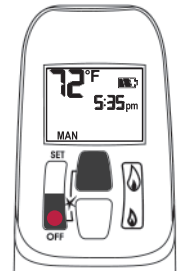

NOTES:

On the valve, MAN button must be at ON, in full counter-clockwise position ↺.

ON/OFF switch (if equipped) must be in I (ON) position.

Turn Fireplace OFF

Press ● button.

When pilot is just turned off, wait 2 minutes to light it again.

Standby Mode (Pilot Flame)

Press and hold 🔥 to set fireplace to pilot.

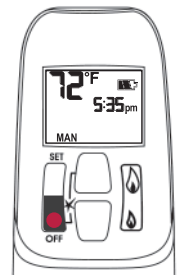

Adjust Flames Height

With pilot lit, press and hold buttons:

🔥 = increase flame height

🔥 = decrease flame height or set to pilot

For fine adjustment, tap buttons.

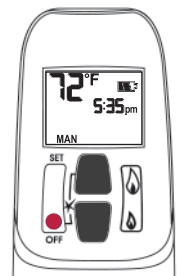

Express Low and High Fire

Double-click buttons:

🔥 = increase flame to maximum height "HI"

🔥 = decrease flame minimum height "LO"

NOTE: Flame goes to high fire first before going to designated low fire.

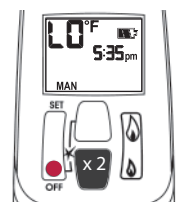
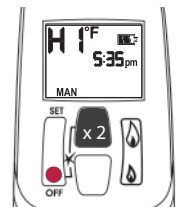

Appendix A - Remote Control Operation

Setting °C/24-hr or °F/12-hr clock

In MAN mode, press ● + 🔥 buttons until temperature / clock display changes from

°F / 12-hour ↔ °C / 24-hour

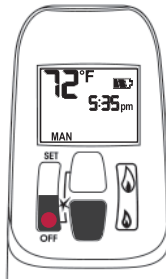

MAN Manual Mode

Manual flame height adjustment.



Setting Time

The time display will flash after either:

- installing the battery, or
- pressing 🔥 + 🔥

To set the time, press buttons:

🔥 = hour

🔥 = minutes

Press ● or wait to go back to MAN.

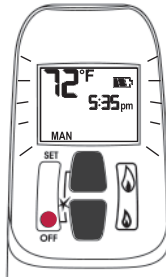

TEMP Daytime Temperature Mode

When pilot is lit, room temperature is measured and compared to set temperature. Flame height automatically adjust to reach Daytime Set Temperature.



💡 Light/Dimmer Mode

Not available on this fireplace.



🌀 Fan Mode

Turns fan ON and OFF and adjusts speed.



Note: To turn fan OFF, press 🔥 until all 4 bars disappear.

Modes of Operation

Briefly press SET cycles through modes of operation.

MAN > TEMP > Light > Fan >

TEMP > TIMER > MAN

NOTE: Press 🔥 or 🔥 to reach MAN mode.

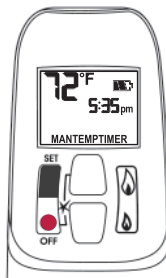

TEMP Night time Setback Temperature Mode

When pilot is lit, room temperature is measured and compared to set temperature. Flame height automatically adjust to reach Night Time Setback Temperature.

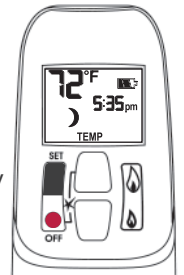

TIMER Timer Mode

When pilot is lit, two periods of time (P1 and P2) can be programmed to use Daytime and Night time temperatures at specific times.

Note: Display shows set temperature every 30 seconds.



Set the different parameters when they are flashing.

Appendix A - Remote Control Operation

Circulating Fan Operation (if equipped)

Circulating fan has 4 speed levels from low to high (1 to 4 bars).

Press SET to scroll to . Fan and level icons flash.

To set speed, press flame buttons:

= increases speed.

= decreases speed and turns OFF fan when all bars disappear.

Note: 8 seconds after the fan is set, handset goes automatically in temperature control mode. Fan starts 4 minutes after gas opens (from OFF or pilot) at maximum speed then goes to displayed level after 10 seconds. Fan stops 10 minutes after gas is OFF or at pilot.

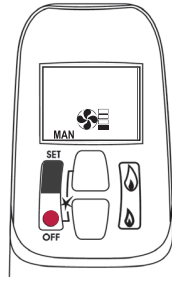

Setting Program Timers

You can program two periods of time between 12 am and 11:50 pm in each 24-hour cycle.

Programs P1 and P2 must be set in the following order during a 24-hour cycle: **P1** , **P1** , **P2** and **P2** .

= Day Time temperature (high) program period

= Night Time temperature (low) program period

Default Settings:

Program 1: **P1** 06:00 am **P1** 08:00 am

Program 2: **P2** 11:50 pm **P2** 11:50 pm

Press SET to scroll to **TIMER**.



If **P1** = **P1** or **P2** = **P2** , programming is cancelled.

To keep fireplace ON all night, set **P2** at 11:50 am and **P1** at 12:00 am.

If you want to program only one period, program **P1** and **P1** with desired times then **P2** and **P2** with the same time as **P1** .

Setting high / low Temperatures

Setting "DAYTIME" high temperature.

Default Settings: **TEMP** 23 °C/74 °F

Press SET to scroll to **TEMP**

Hold SET button until TEMP flashes.

To set Daytime Temperature:

= increases temperature.

= decreases temperature.

Press or wait to complete setting.

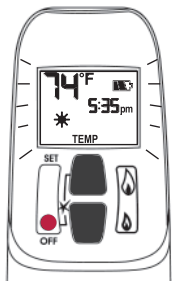

Setting P1 time - high temperature.

Hold SET button until **P1** is displayed and time flashes.

To set time:

= hour

= minutes

Press or wait to complete setting.

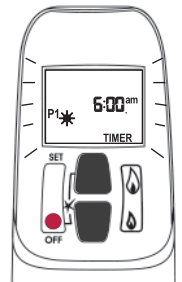

Setting "NIGHT TIME SETBACK" low temperature.

Default Settings: **TEMP** "--" (OFF)

Press SET to scroll to **TEMP**

Hold SET button until TEMP flashes.

To set Night Time Temperature:

= increases temperature.

= decreases temperature.

Press or wait to complete setting.

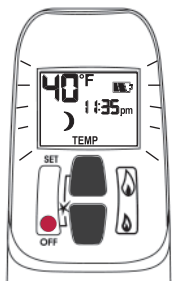

Setting P1 time - low temperature.

Hold SET button until **P1** is displayed and time flashes.

To set time:

= hour

= minutes

Press or wait to complete setting.

Appendix A - Remote Control Operation

Setting P2 high and low temperature times.

Repeat same steps as Setting P1.

When all settings are complete, press ● to save them.

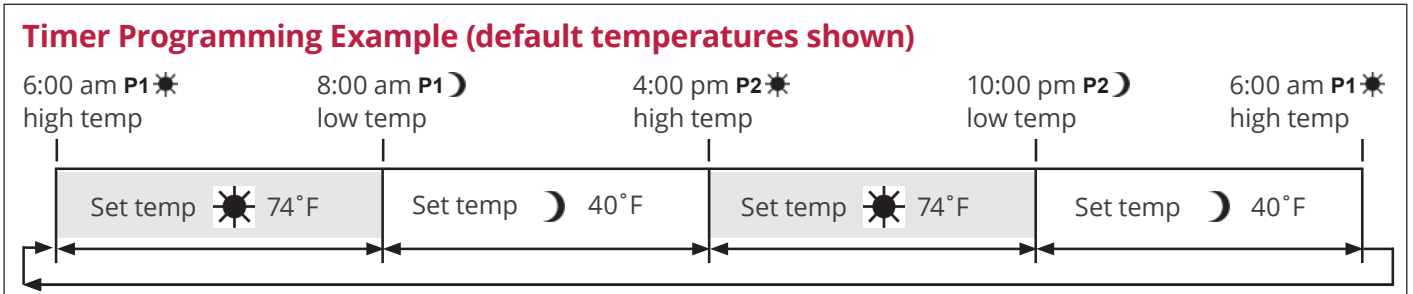

Automatic Turn Down

8 Hour no Motor Movement

The valve will turn to pilot flame if there is no motor movement for an 8-hour period.

Automatic Shut-Off

Low Batteries Receiver. With low battery power in the battery holder the system shuts off the fire completely. This does not apply when the power supply is interrupted.

On-Demand Pilot (7 Day Shut-Off). This green feature eliminates gas energy consumption during extended appliance inactivity. When the appliance is inactive for an extended period of time the system automatically extinguishes the pilot. This feature helps the consumer realize cost benefits by automatically eliminating energy consumption during non-heating months and limited use.

The programmed length of inactivity to activate the system is specified by the appliance manufacturer and cannot be altered in the field.

Low Battery Indication

Handset: The battery icon  will show when the battery needs to be replaced. Replace with one 9 V **alkaline**

Caution

DO NOT USE a screwdriver or other metallic object to remove batteries from holder. This could cause a short-circuit.

battery.

Battery holder: Frequent 'beeps' for 3 seconds when the valve motor turns indicate the batteries need to be replaced in battery holder. Replace with four 1.5 V **alkaline** batteries.

Handset / Receiver Match

The remote control handset and receiver are programmed to function together. In case of a replacement of the handset or the receiver, you will need to reset the receiver to allow them to function together. Contact your dealer for details.

Appendix B - Wall Switch Operation

The Wall Switch can be used to control your fireplace. You can turn the pilot on or off and you can increase or decrease the flame height.

Note that the thermostat and programming functions are not available with the wall switch.

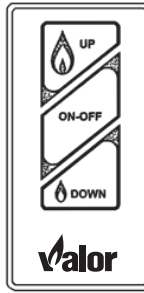

Adjusting Flame Height

Press and hold large flame  button to gradually increase flame height.

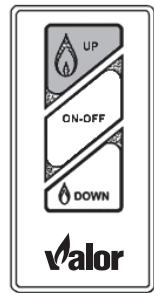

Turning Appliance ON and OFF

Press ON-OFF button once to light pilot. Press again to shut off pilot.

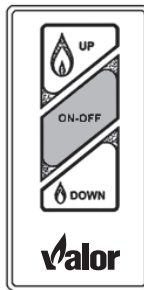

Press and hold small flame  button to gradually decrease flame height.

