

ADDENDUM to H3/G4 780M Log Installation

May 2021

Valor® H3/G4 780M

1000DWKV2 Driftwood Log Kit— Replaces Installation Instructions for 1000DWK

Description

The 1000DWKV2 log kit is an upgrade of the 1000DWK kit. Some of the logs have been altered and others removed for better and improved flame picture.

Use of 1000DWKV2 Log Kit

This Addendum describes how to properly install the 1000DWKV2 Driftwood Log Kit into either an H3 or G4 780M Valor fireplace.

Material Required

- 1000DWKV2 Driftwood Log Kit, which contains:
 - 8 logs
 - 3 pebbles
 - 1 cover plate
 - 2 cups of embers (bagged)

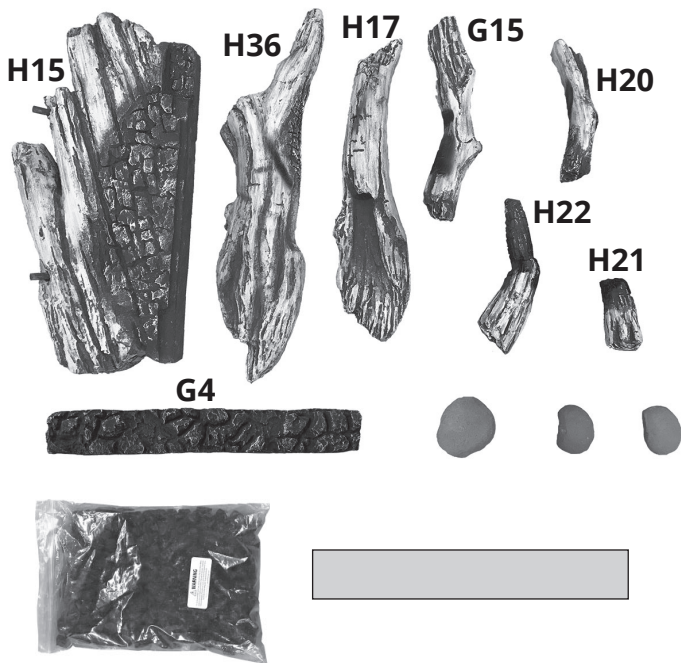

- Gloves, if desired

Spare Parts

Item	Part Number
Log H15	4007494
Log H36	4008618
Log H17	4007496
Log G4	4008162
Log H22	4008904
Log G15	4008305
Log H20	4007499
Log H21	4007500
Pebbles (3)	4008173
Embers—2 cup bag	4008304
Cover plate	4007895

Burner cover/Rear log support

This kit can be installed on H3 or G4 780M fireplaces with either version of the burner cover/rear log support illustrated below:

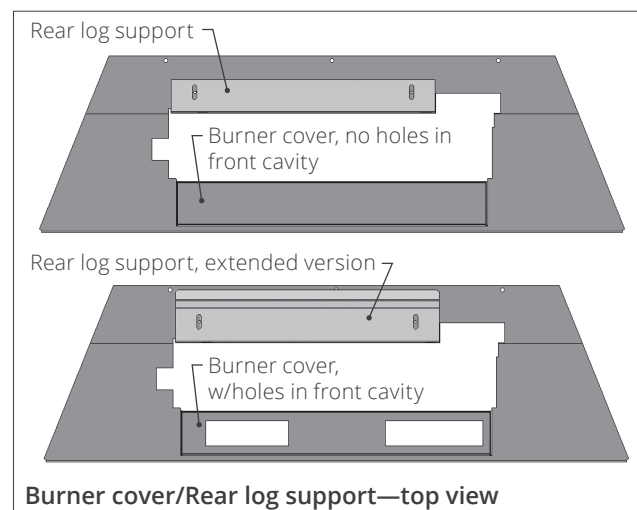

Installation

Carefully unpack the kit. Note each log has its own number stamped on the bottom. Some logs have pegs to help you place them on other logs.

Install the logs as follows.

1. **G4 780M fireplaces ONLY:** Place the front brick panels that shipped with the fireplace at the front of the support platform. See "Completed G4 780M 1000DWKV2 Assembly" on page 4 or the G4 780M Installation Manual for details if needed.
2. **Burner cover with holes in front cavity:** Place cover panel supplied with the log set into the recess in front of the burner.

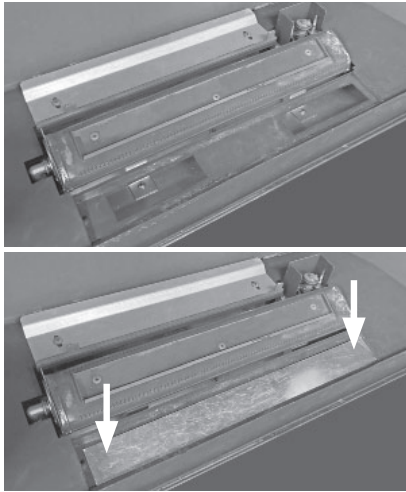

3. Place log G4 directly on the burner, its underside groove fitting on the front raised flange of the burner. Slide the log all the way to the left.

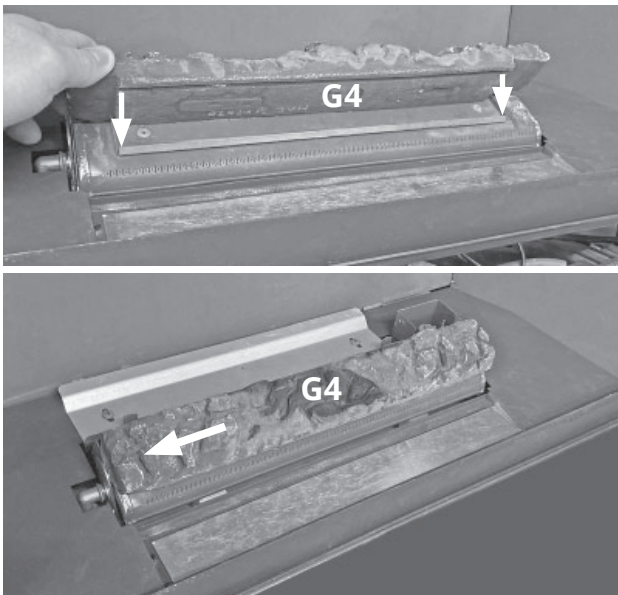

4. Place log H15 onto the rear support bracket, and slide it as far to the right as it will travel, gently resting the log against the pilot shield.

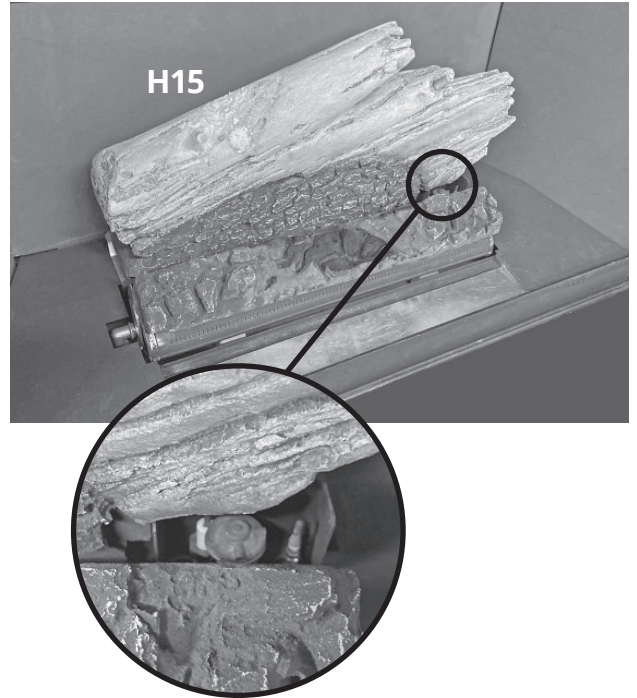

5. Place log H22 at the right end of G4, on top of the cover panel.



6. Place log G15 from the cover panel to the groove in H22.



7. Place log H20 from the left side of G4 to the top groove of G15.



8. Place log H17 as shown. Note the hole in H17 fits onto the pin in H15.

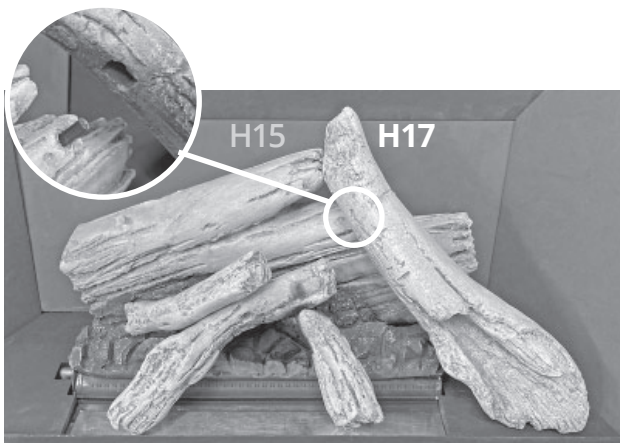

9. Place log H36 as shown. Note the hole in H36 fits onto the pin in H15.

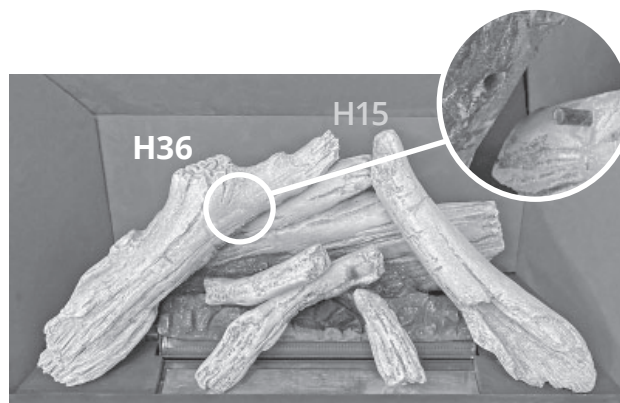

10. Place embers as shown on the cover plate. You may not need to use all the embers.



11. Place log H21 on top of the embers between G15 and H22.

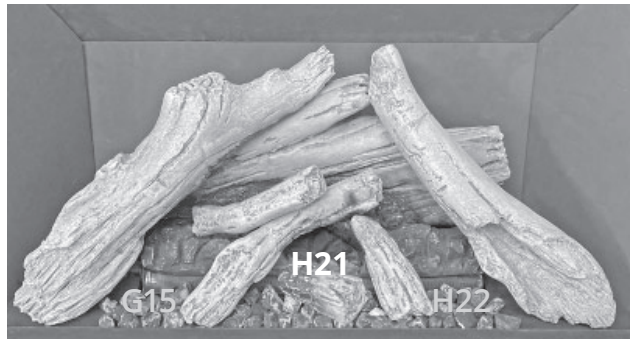

12. Place pebbles as desired.



This completes the installation of the 1000DWK kit into the fireplace. Complete the fireplace installation using its Installation Manual.

Completed H3 1000DWKV2 Assembly

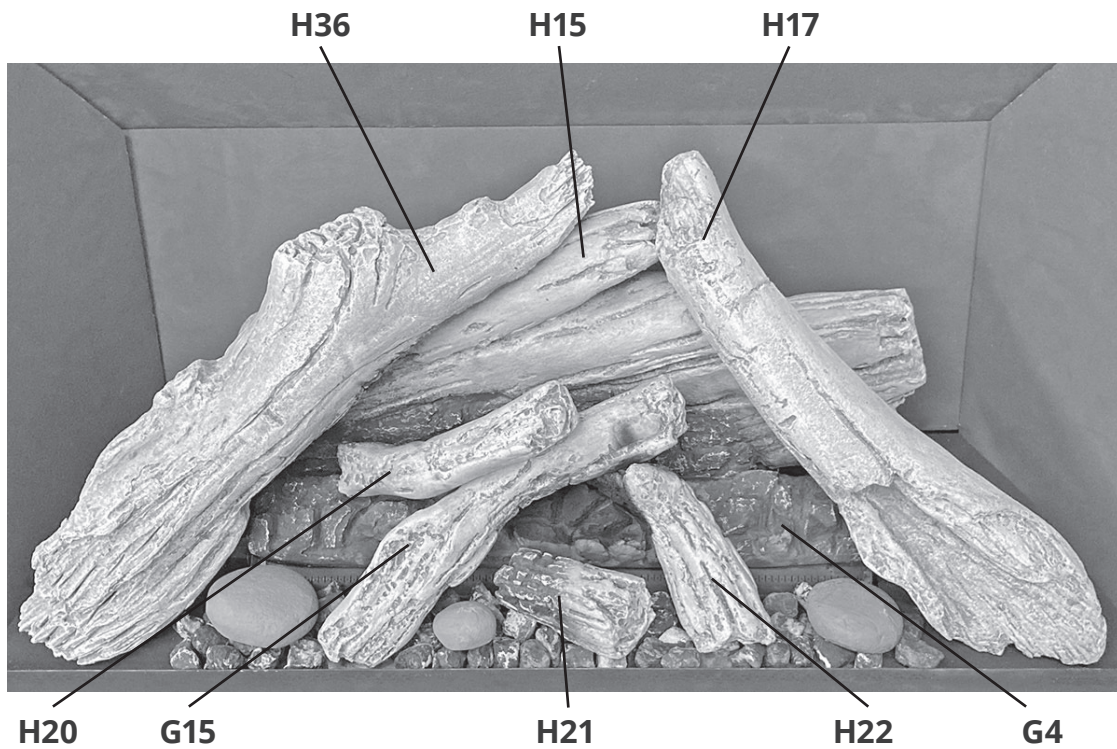

Completed G4 780M 1000DWKV2 Assembly

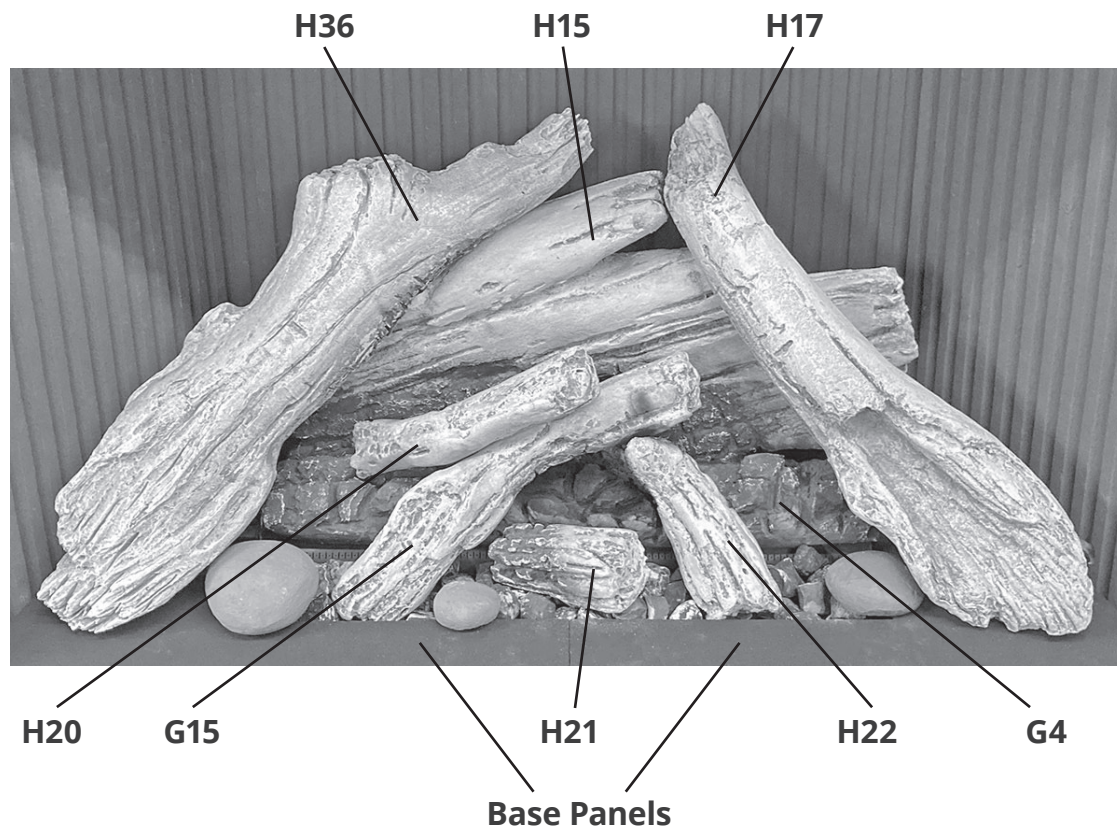

Because our policy is one of constant development and improvement, details may vary slightly from those given in this publication.

Designed and Manufactured by / for Miles Industries Ltd.

190 - 2255 Dollarton Highway, North Vancouver, B.C., CANADA V7H 3B1

Tel. 604-984-3496 Fax 604-984-0246

www.valorfireplaces.com

ADDENDUM—Installation bûches H3/G4 780M

Mai 2021

valor® H3/G4 780M

Bois de grève 1000DWKV2— Remplace instructions d'installation 1000DWK

Description

L'ensemble Bois de grève 1000DWKV2 remplace l'ensemble 1000DWK. Certaines bûches ont été supprimées et d'autres modifiées pour un meilleur ajustement et une flamme améliorée.

Cet Addendum décrit comment installer l'ensemble Bois de grève 1000DWKV2 dans les foyers Valor H3 et G4 780M.

Pièces requises

- Bois de grève 1000DWKV2, contenant :
 - 8 bûches
 - 3 galets
 - 1 couvercle de métal
 - 1 sac de braises de 2 tasses
- Gants, si désiré

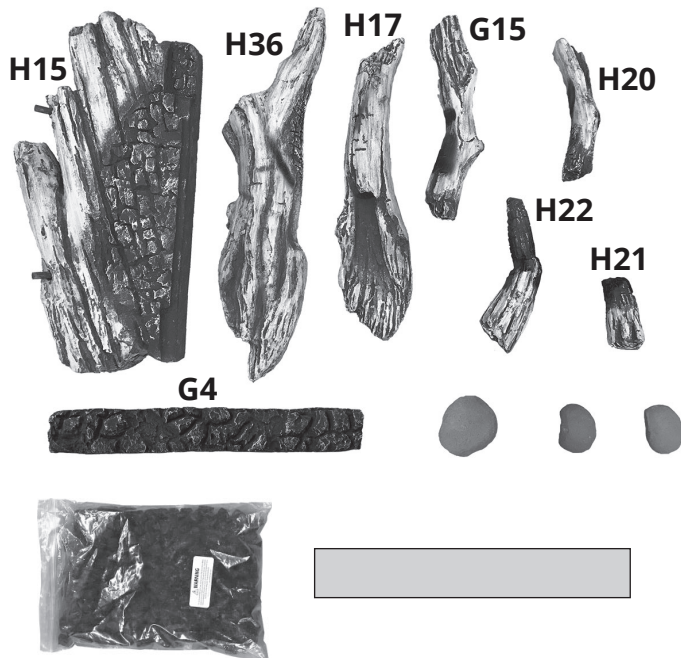

Pièces

Description	Pièce n°
Bûche H15	4007494
Bûche H36	4008618
Bûche H17	4007496
Bûche G4	4008162
Bûche H22	4008904
Bûche G15	4008305
Bûche H20	4007499
Bûche H21	4007500
Galets (3)	4008173
Braises—sac de 2 tasses	4008304
Couvercle de métal	4007895

Couvercle du brûleur/Support de bûche

Cet ensemble peut être installé dans les foyers H3 ou G4 780M avec une ou l'autre version du couvercle du brûleur et support de bûche arrière :

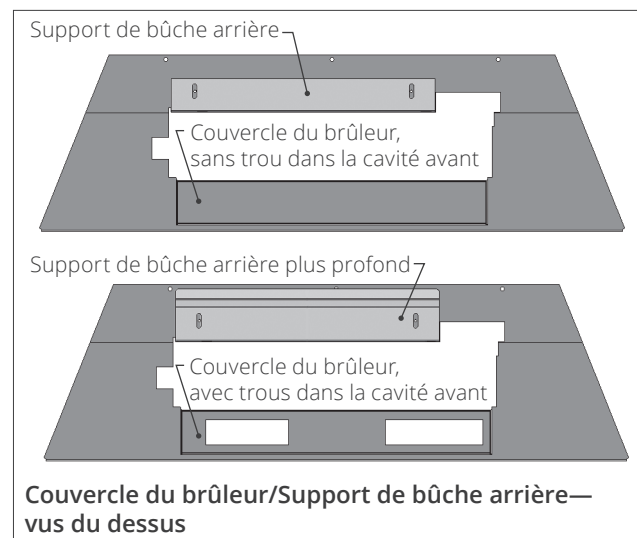

Installation

Déballez l'ensemble avec soins. Chaque bûche comporte un numéro gravé en-dessous. Certaines bûches ont également des chevilles aidant à les tenir en place.

1. **Foyers G4 780M seulement.** Une fois les panneaux intérieurs installés, assurez-vous que les briques avant soient également installées avant les bûches.
2. **Couvercle de brûleur avec trous dans la cavité avant.** Placez le couvercle de métal fourni dans la partie creuse devant le brûleur.

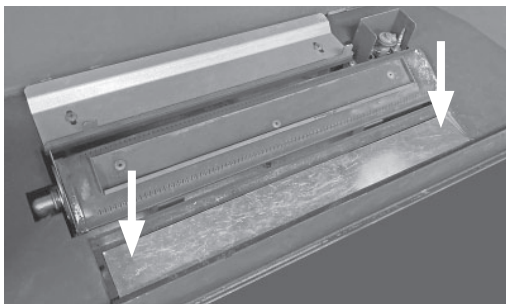
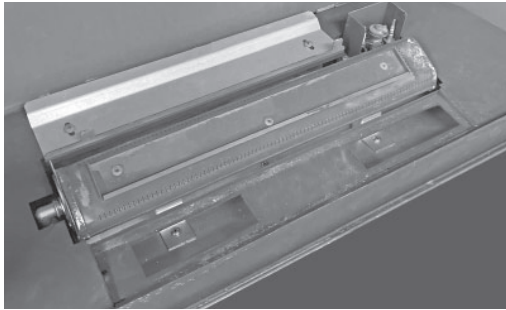

3. Placez la bûche G4 directement sur le brûleur, la fente sous la bûche sur le rebord montant du dessus du brûleur. Glissez la bûche le plus possible vers la gauche.

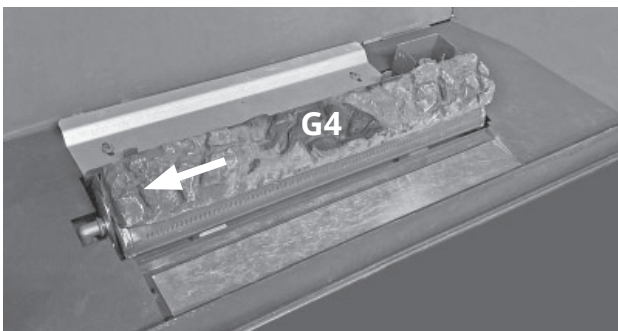
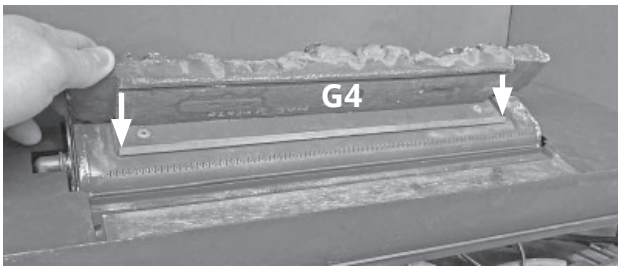

4. Placez H15 sur le support derrière le brûleur et poussez-la vers la droite contre l'écran de veilleuse.

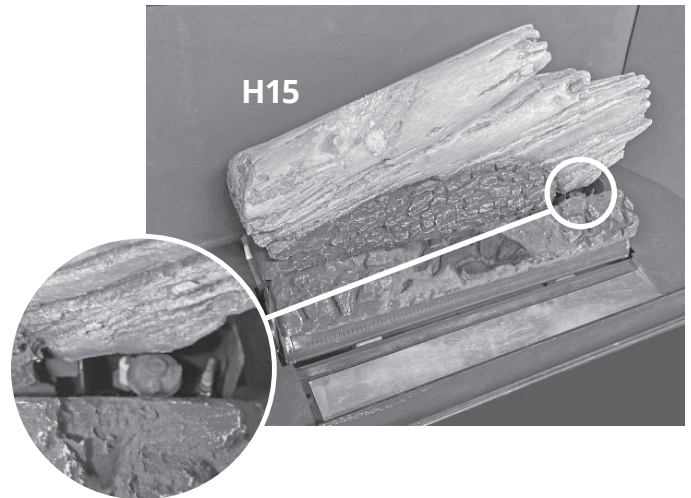

5. Placez le bout brûlé de G14 sur le centre droit de G4 et son bout pâle sur le couvercle de métal.



6. Placez G15 dans l'encoche sur H22 puis posez son autre bout sur le couvercle de métal devant le brûleur.



7. Placez H20 sur le dessus de G15 et posez l'autre bout sur G4.



8. Placez H17 sur la cheville droite de H15 et posez son autre bout à droite devant le brûleur.

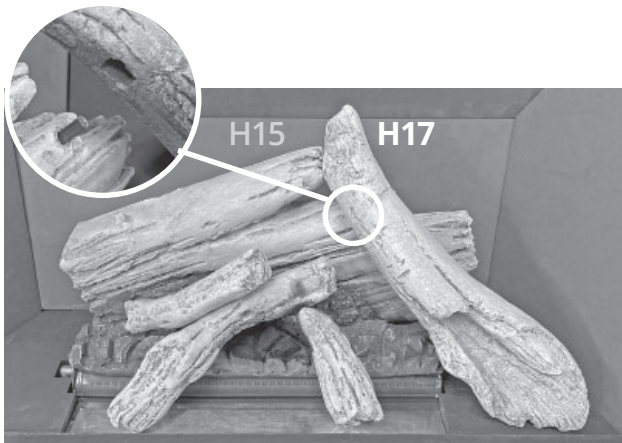

9. Placez H36 sur la cheville gauche de H15 et posez son autre bout à gauche devant le brûleur.

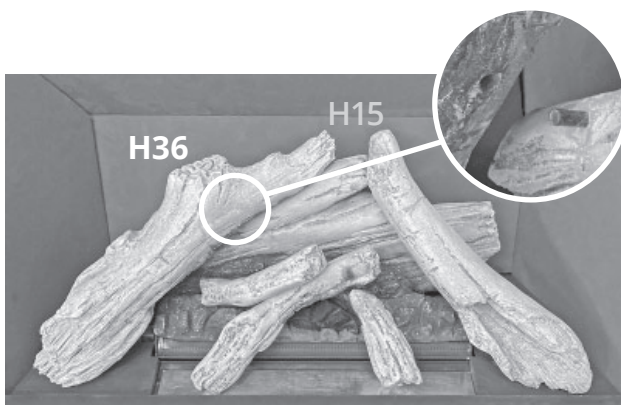

10. Placez des braises sur le couvercle de métal. Il n'est pas nécessaire d'utiliser toutes les braises.



11. Placez H21 sur les braises entre G15 et H22.



12. Placez les galets au choix.



Une fois l'ensemble installé, continuez l'installation du foyer à l'aide du Guide d'installation fourni avec le foyer.

Bois de grève 1000DWKV2 dans le H3

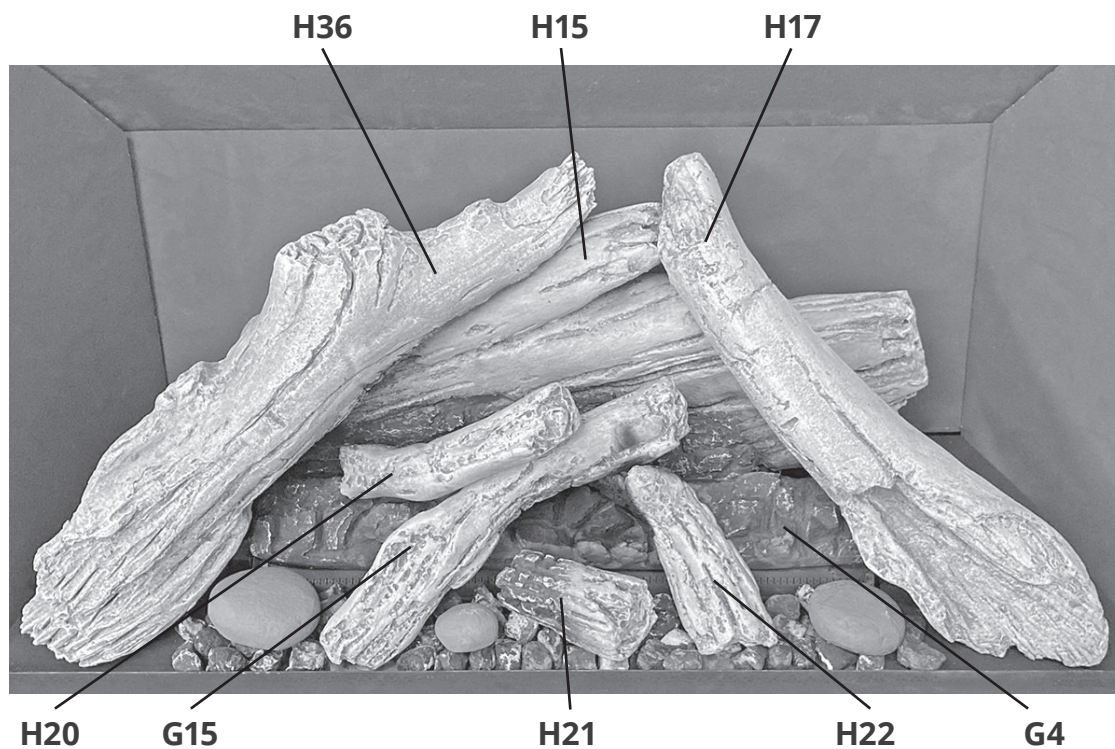

Bois de grève 1000DWKV2 dans le G4 780M

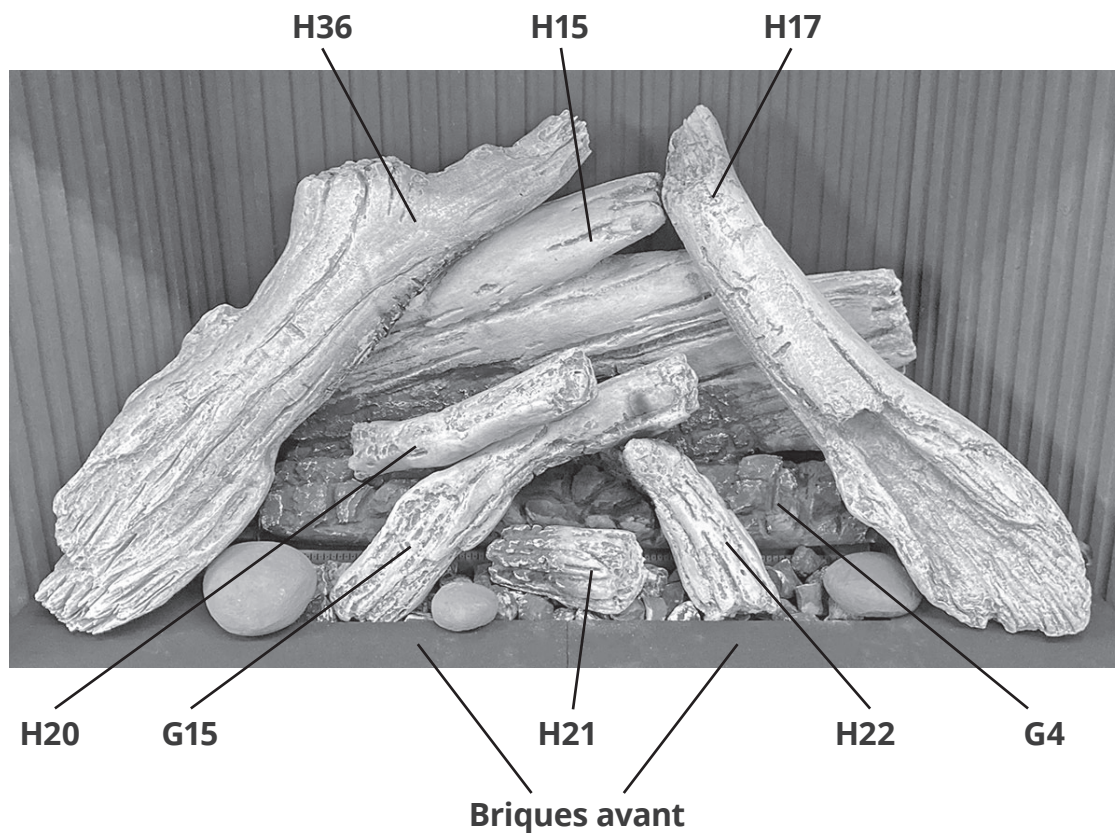

Parce que nous favorisons une politique de développement continu, certains détails de la présente publication peuvent varier.

Conçue et fabriquée par / pour Miles Industries Ltd.

190 - 2255 Dollarton Highway, North Vancouver, BC, CANADA V7H 3B1

Tél. 604-984-3496 Téléc. 604-984-0246

www.foyervalor.com