

# INSTALLATION & OWNER'S MANUAL

# valor® G4

# with AutoFire™



## Direct Vent Gas Insert Fireplace 785KLN (natural gas) & 785KLP (propane gas)

Canadian Patent 2717779  
US and other patents  
pending

# DANGER



**HOT GLASS WILL  
CAUSE BURNS.**

**DO NOT TOUCH GLASS  
UNTIL COOLED.**

**NEVER ALLOW CHILDREN  
TO TOUCH GLASS.**

A barrier designed to reduce the risk of burns from the hot viewing glass is provided with this appliance and must be installed for the protection of children and other at-risk individuals.

**Please read this manual  
BEFORE installing and  
operating this appliance.**

## INSTALLER

Leave this manual  
with the appliance.

## CONSUMER

Retain this manual  
for future reference.

### WARNING

#### FIRE OR EXPLOSION HAZARD

Failure to follow safety warnings exactly could result in serious injury, death, or property damage.

- Do not store or use gasoline or other flammable vapors and liquids in the vicinity of this or any other appliance.
- **WHAT TO DO IF YOU SMELL GAS**
  - Do not try to light any appliance.
  - Do not touch any electrical switch; do not use any phone in your building.
  - Leave the building immediately.
  - Immediately call your gas supplier from a neighbor's phone. Follow the gas supplier's instructions.
  - If you cannot reach your gas supplier, call the fire department.
- Installation and service must be performed by a qualified installer, service agency or the gas supplier.

This manual contains instructions to install the **ENGINE ONLY**. A front is **also REQUIRED** to complete this installation. A barrier screen is provided with the front. **Refer to the manual supplied with the front for installation.**

**This appliance may be installed in an after-market permanently located, manufactured (mobile) home where not prohibited by local codes.**

**This appliance is only for use with the type of gas indicated on the rating plate. This appliance is not convertible for use with other gases, unless a certified kit is used.**

**This appliance is a domestic room-heating appliance. It must not be used for any other purposes such as drying clothes, etc.**

**This appliance is suitable for installation in a bedroom or bed sitting room.**

Ce guide est disponible en français sur demande.

# Table of Content

## FOR THE OWNER

<b>Safety and Your Fireplace</b> .....	<b>3</b>
<b>Introduction</b> .....	<b>6</b>
Locating Fireplace & Lighting Information Card .....	6
Operating Your Fireplace for the First Time.....	6
<b>Operating Your Fireplace</b> .....	<b>7</b>
Fireplace Control Devices .....	7
How to Turn Your Fireplace ON.....	7
How to Turn Your Fireplace OFF (including pilot).....	7
How to Ensure Your Fireplace Cannot Be Turned ON Inadvertently .....	7
<b>Using the Remote Control</b> .....	<b>8</b>
<b>Kits &amp; Accessories</b> .....	<b>12</b>
<b>Lighting Instructions</b> .....	<b>13</b>
<b>Servicing &amp; Maintenance</b> .....	<b>14</b>
Servicing Your Fireplace.....	14
Annual Inspection.....	14
Cleaning Your Fireplace .....	15
Checking Pilot and Burner Flames.....	17
Replacing Batteries .....	18
Using Handset Wall Holder.....	18
<b>Warranty</b> .....	<b>40</b>

## FOR THE QUALIFIED INSTALLER

<b>Specifications</b> .....	<b>19</b>
<b>Overview</b> .....	<b>20</b>
<b>Dimensions</b> .....	<b>21</b>
<b>Cavity</b> .....	<b>21</b>
<b>Clearances</b> .....	<b>22</b>
<b>Venting</b> .....	<b>23</b>
<b>Existing Fireplace Preparation</b> .....	<b>24</b>
<b>Installation Planning</b> .....	<b>24</b>
<b>Installation</b> .....	<b>25</b>
Unpack the appliance .....	25
Remove Window .....	26
Install Fan (if used).....	26
Connect Venting .....	27
Connect Gas Supply.....	28
Install Liner Panels .....	30
Install Ceramic Logs .....	31
Refit and Check Window .....	34
Synchronize Remote Control.....	35
Check Operation.....	36
Adjust Aeration (if necessary).....	36
Install Side Shrouds.....	37
Install Front, Trim and Barrier Screen.....	37
Install Handset Wall Holder .....	37
<b>Wiring Diagram</b> .....	<b>38</b>
<b>Approved Venting Components</b> .....	<b>39</b>
<b>Warranty</b> .....	<b>40</b>
<b>Spare Parts</b> .....	<b>41</b>



**NATIONAL FIREPLACE INSTITUTE**  
**NFI**  
**CERTIFIED**  
[www.nficertified.org](http://www.nficertified.org)

We recommend that our gas hearth products be installed and serviced by professionals who are certified in the U.S. by the National Fireplace Institute® (NFI) as NFI Gas Specialists.

**Massachusetts:** The piping and final gas connection must be performed by a licensed plumber or gas fitter in the State of Massachusetts.

The information contained in this installation manual is believed to be correct at the time of printing. Miles Industries Ltd. reserves the right to change or modify any information or specifications without notice. Miles Industries Ltd. grants no warranty, implied or stated, for the installation or maintenance of your heater, and assumes no responsibility for any consequential damage(s).

**Designed and Manufactured by / for**  
**Miles Industries Ltd.**  
**190–2255 Dollarton Highway, North Vancouver, BC, CANADA V7H 3B1**  
**Tel. 604-984-3496 Fax 604-984-0246**  
**[www.valorfireplaces.com](http://www.valorfireplaces.com)**



## SAFETY AND YOUR FIREPLACE

**Read and understand** all instructions carefully before starting the installation. **Failure to follow** these installation instructions may result in possible fire hazard and will void the warranty.

**Prior to the first firing of the fireplace**, read the Owner's information section of this manual.

**Do not use this appliance if any part has been under water.** Immediately, call a qualified service technician to inspect the unit and to replace any part of the control system and any gas control that has been under water.

**This unit is not for use with solid fuel.**

**Installation and repair should be performed by a qualified service person.** The appliance and venting system should be **inspected** before initial use and at least annually by a professional service person. More frequent cleaning may be required due to excessive lint from carpeting, bedding, etc. It is **imperative** that the unit's control compartment, burner, and circulating air passageways **be kept clean** to provide for adequate combustion and ventilation air.

**Always keep the appliance clear and free from combustible materials**, gasoline, and other flammable vapors and liquids.

**Never obstruct the flow of combustion and ventilation air.** Keep the front of the appliance **clear** of all obstacles and materials for servicing and proper operation.

**This unit must be used with a vent system** as described in this installation manual. **No other vent system or components may be used.**

This gas fireplace and vent assembly must be vented directly to the outside and must never be attached to a chimney serving a separate solid fuel burning appliance. Each gas appliance must use a separate vent system. Common vent systems are prohibited.

**Inspect the external vent cap** on a regular basis to make sure that no debris, plants, trees, shrubs are interfering with the air flow.

**Turn off the gas before servicing** this appliance. It is recommended that a qualified service technician perform an appliance check-up at the beginning of each heating season.



### **WARNING:**

This product can potentially expose you to chemicals including Benzene which are known to the State of California to cause cancer and birth defects or other reproductive harm. **For more information go to [www.P65Warnings.ca.gov](http://www.P65Warnings.ca.gov)**

**Do not use this heater as a temporary source of heat during construction.**

Due to the high temperature, the appliance should be **located** out of traffic areas and away from furniture and draperies.

Clothing or flammable material **should not be placed** on or near the appliance.

This appliance is a **domestic room-heating appliance**. It must not be used for any other purposes such as drying clothes, etc.

**Do not** place furniture or any other combustible household objects within 36" of the fireplace front.

**Be careful not to put any decorating objects** sensitive to heat to close above or around the fireplace as it gets very hot when operating.

**The glass door assembly must be in place and sealed before the unit can be placed into safe operation.**

**Do not operate this appliance with the glass door removed, cracked, or broken.** Replacement of the glass door should be performed by a licensed or qualified service person. Do not strike or slam the glass door.

**The glass door assembly shall only be replaced as a complete unit**, as supplied by the fireplace manufacturer. No substitute material may be used.

Do not use abrasive cleaners on the glass door assembly. Do not attempt to clean the glass door when it is hot.

**A barrier designed to reduce the risk of burns** from the hot viewing glass is provided with this appliance and **shall be installed for the protection of children and other at-risk individuals.**

If the barrier becomes damaged, the barrier shall be replaced with the manufacturer's barrier for this appliance.

Any safety screen, guard or barrier removed for servicing the appliance, must be replaced prior to operating the appliance.

**Children and adults** should be alerted to the hazards of high surface temperature and should stay away to avoid burns or clothing ignition.

**Young children** should be carefully supervised when they are in the same room as the appliance. Toddlers, young children and others may be susceptible to accidental contact burns. A physical barrier is recommended if there are at-risk individuals in the house. To restrict access to a fireplace or stove, install an adjustable safety gate to keep toddlers, young children and other at-risk individuals out of the room and away from hot surfaces.



# Safety and Your Fireplace

## Read and carefully follow all safety warnings and operating instructions contained in your owner's manual

Replacement manuals are available by contacting the Valor Service Department at 1-800-468-2567 or visit [www.valorfireplaces.com](http://www.valorfireplaces.com).

### FOLLOW THESE IMPORTANT CHILD SAFETY PRECAUTIONS AND RECOMMENDATIONS

**Parts of your Valor Fireplace become extremely hot while in operation.**

**The glass viewing window temperature can exceed 500 F at full capacity.**

**Momentary contact with a hot glass surface can cause a severe burn**, even if the fireplace is operating at reduced heating capacity.

**The glass window will remain hot** for an extended period of time after the fireplace has been turned off. Ensure that children are prevented from touching the fireplace during the cool down period.

**Toddlers and Young Children must be closely supervised at all times** when they are in the same room as the operating fireplace. They lack full awareness of danger and rely on your protection. Toddlers, in particular, do not have the motor skills and response reflexes to withdraw in the event of accidental contact with a hot surface.

**A physical barrier is strongly recommended** if there are young children, or at-risk individuals in the house. Install an approved after-market safety gate to keep toddlers, young children and



other at-risk individuals a safe distance from the fireplace.

**Keep the remote control handset out of reach of children at all times.** A wall mount storage holster is provided with your remote control handset.

**Ensure that the fireplace, including the pilot light, is completely turned off** when children are present and close supervision and safety barriers are not available—see page 7 of this manual.

**If the fireplace is not going to be used** for the summer or any extended period of time, remove the batteries from the remote control handset and remote battery holder. It is recommended that batteries are replaced annually in any event—see page 18.



## SAFETY AND YOUR FIREPLACE

This manual and particularly the preceding and following pages contain very important information regarding the safe operation of your fireplace as well as maintenance instructions. Read carefully before operating your fireplace and pay special attention to the safety warnings.

A heating gas appliance does require safe handling. For this reason, we very strongly recommend children are not allowed to touch the fireplace or controls. **Install a screen or barrier in front of the fireplace to protect your children against severe burns.**

This appliance is designed and approved as a supplemental heater and provides the potential for most energy conservation when used while attended. The use of an alternate primary heat source is advisable.



## WARNING EXTREMELY HOT!!!

- **Read the safety information on pages 3 and 4 of this manual before operating your gas heater.**
- Some parts of your fireplace are **extremely hot**, particularly the **glass** window.
- **Do not let children touch the glass** or any parts of your fireplace **even after it is turned off** as it is still hot.
- **Use the barrier screen** provided with the trim or a gate to reduce the risk of severe burns.
- Keep the remote control handset **out of reach of children.**
- **Hot hearth/floor surface!** The hearth or floor directly in front of the fireplace is very hot when the fireplace heats. Even if constructed of non-combustible materials, and although safe, it may reach temperatures **in excess of 200° F** depending on choice of materials. **Do not step on it!**
- Some materials or items, although safe, may discolor, shrink, warp, crack, peel, and so on because of the heat produced by the fireplace. **Avoid placing** candles, paintings, photos, and other items **sensitive to heat** within 36 inches (0.9 m) around the fireplace.
- Solid wood flooring in front of the fireplace (if allowed) may shrink during the heating season due to heat.

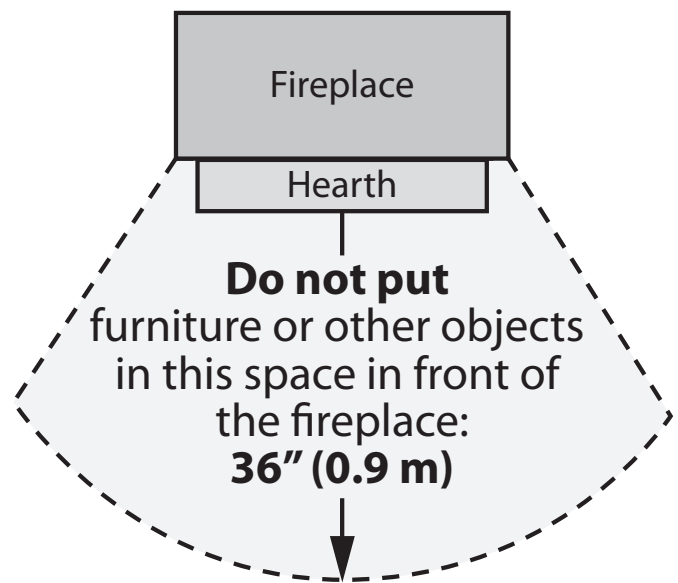



# Operating Your Fireplace

## Fireplace Control Devices

There are three ways to control your fireplace.

1. Thermostatic Remote Control can be programmed to function automatically—see pages 8–11;
2. Wall Switch (optional) turns fire on, off and controls flame height—see 1265WSK or RBWSK—Wall Switch Kit;  
**NOTE:** The remote control in the AUTO mode will override the wall switch.
3. Manual On/Off Switch on gas valve—must be ON for the fireplace to function. It can be used to shut off the fireplace in case of emergency—see below.

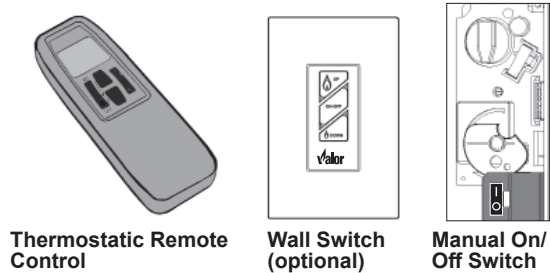

## How to Turn Your Fireplace ON

Press and hold button(s) until a short beep confirms the start sequence has begun; release buttons. Continuing beeps confirm the ignition is in process. When the pilot is lit, the gas flows—see *Using Your Remote Control* section for more information.

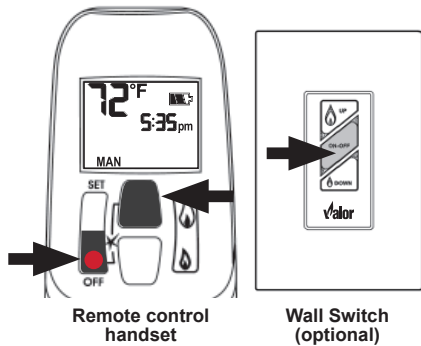

## How to Turn Your Fireplace OFF (including pilot)

Press and hold the OFF button for a second.

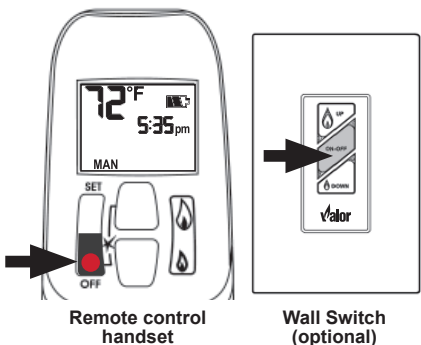

If the flames are on, they go down and you hear the valve motor wind down. You hear a clunk and a beep indicating that the valve has received the signal from the remote control.

In the unlikely event that you cannot turn off your fireplace with the remote control handset, use the wall switch (if installed); if the wall switch malfunctions and will not turn off the fireplace, wait 6 hours and the fireplace will automatically go to pilot. You can then access the controls inside your fireplace. Alternately, turn off gas supply. In all cases, call your dealer for service assistance.

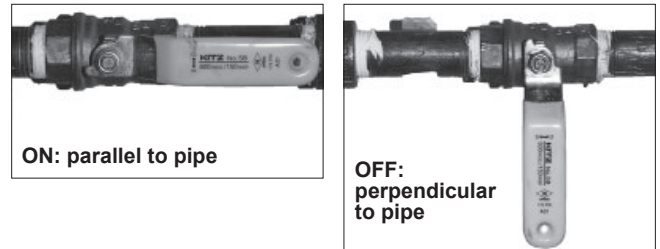

## How to Ensure Your Fireplace Cannot Be Turned ON Inadvertently

### ⚠ WARNING

**RISKS OF SEVERE BURNS! SURFACES OF THE FIREPLACE ARE VERY HOT DURING OPERATION!** Be very careful and wear gloves to access controls.

You can use one of the two following methods to ensure that your fireplace will not turn on when you don't want it on.

- You can prevent your fireplace from lighting by pressing the **O** button on the manual ON/OFF switch on the gas valve.

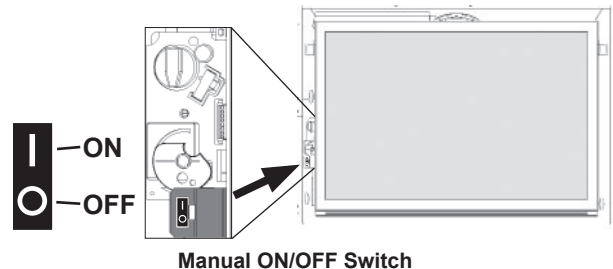

- Alternately, you can remove all batteries from the receiver as well as the battery from the handset.

## Automatic Shut-Off (in certain conditions)

Your fireplace's remote control is equipped with an automatic shut-off mechanism which is activated in certain conditions. See page 11 in the *Using the Remote Control* section for a description of this feature.

## Using the Remote Control

### Radio Frequency

315 MHz for USA and Canada.

This device complies with Part 15 of the FCC Rules and with Industry Canada license-exempt RSS standard(s). Operation is subject to the following two conditions:  
(1) this device may not cause harmful interference, and  
(2) this device must accept any interference received, including interference that may cause undesired operation.

**NOTE: Before using the remote control system for the first time**, the receiver and the handset must be synchronized. See the section *Synchronize Remote Control*.

**IMPORTANT: BEFORE YOU BEGIN**, please note that on this system, the settings of time, temperature and automatic ON/OFF **can only be programmed when the function display is flashing**. Be patient when programming as it can take a few seconds to set.

Note: In the TEMP or TIMER modes, the remote handset senses the room temperature and adjusts the flame accordingly.

To communicate, the handset should be within 15 feet (4.5 meters) of the fireplace.

**Do not leave the handset on the mantel or hearth.**

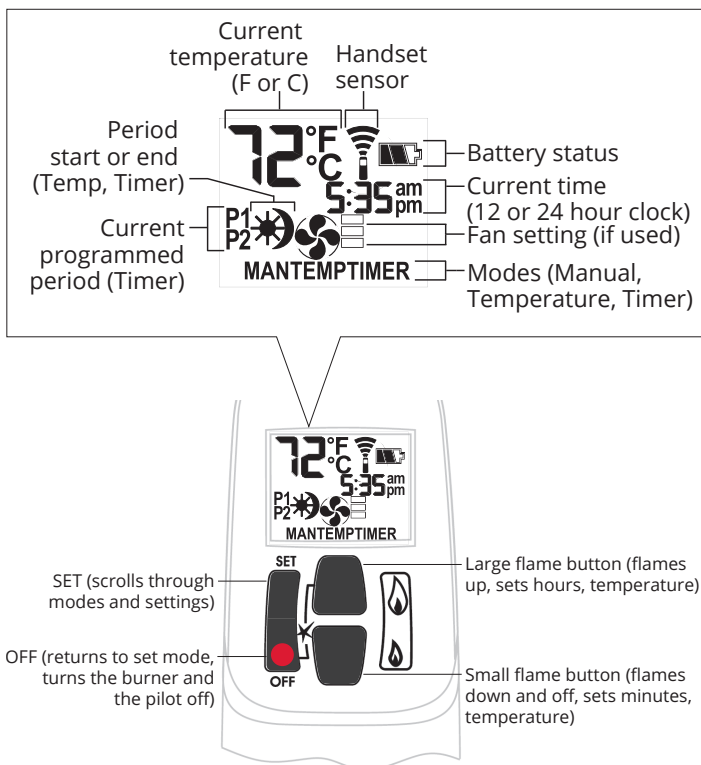

### Turn Fireplace ON

Press ● + 🔥 buttons until you hear a short beep; release buttons.

Beeps continue until pilot is lit.

Burner lits to maximum flame height and handset goes automatically to manual (MAN) mode.

NOTES:

On the valve, MAN button must be at ON, in full counter-clockwise position .

ON/OFF switch (if equipped) must be in I (ON) position.

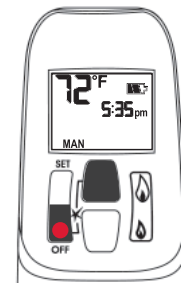

### Turn Fireplace OFF

Press ● button.

When pilot is just turned off, wait 2 minutes to light it again.

### Standby Mode (Pilot Flame)

Press and hold 🔥 to set fireplace to pilot.

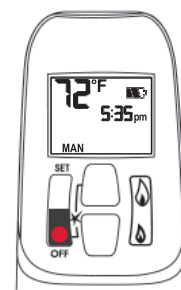

### Adjust Flames Height

With pilot lit, press and hold buttons:

- 🔥 = increase flame height
- 🔥 = decrease flame height or set to pilot

For fine adjustment, tap buttons.

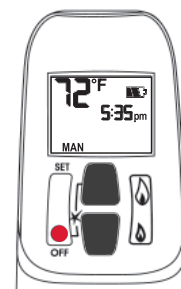

### Express Low and High Fire

Double-click buttons:

- 🔥 = increase flame to maximum height "HI"
- 🔥 = decrease flame minimum height "LO"

NOTE: Flame goes to high fire first before going to designated low fire.

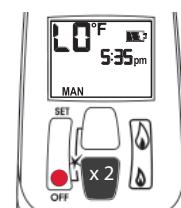
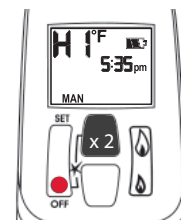



## Using the Remote Control

### Setting °C/24-hr or °F/12-hr clock

In MAN mode, press ● + 🔥 buttons until temperature / clock display changes from

°F / 12-hour ↔ °C / 24-hour

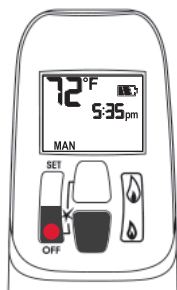

### Setting Time

The time display will flash after either:

- installing the battery, or
- pressing 🔥 + 🔥

To set the time, press buttons:

🔥 = hour

🔥 = minutes

Press ● or wait to go back to MAN.

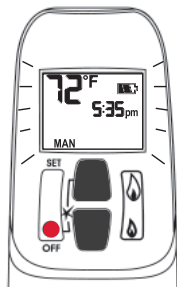

### Modes of Operation

Briefly press SET cycles through modes of operation.

MAN > TEMP > Light > Fan >

TEMP > TIMER > MAN

NOTE: Press 🔥 or 🔥 to reach MAN mode.

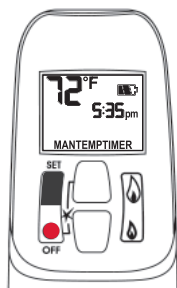

### MAN Manual Mode

Manual flame height adjustment.



### TEMP Daytime Temperature Mode

When pilot is lit, room temperature is measured and compared to set temperature. Flame height automatically adjust to reach Daytime Set Temperature.

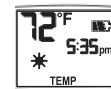

### Light/Dimmer Mode

Not available on this fireplace.



### Fan Mode

Turns fan ON and OFF and adjusts speed.

Note: To turn fan OFF, press 🔥 until all 4 bars disappear.



### TEMP Night time Setback Temperature Mode

When pilot is lit, room temperature is measured and compared to set temperature. Flame height automatically adjust to reach Night Time Setback Temperature.

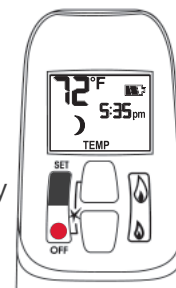

### TIMER Timer Mode

When pilot is lit, two periods of time (P1 and P2) can be programmed to use Daytime and Night time temperatures at specific times.

Note: Display shows set temperature every 30 seconds.

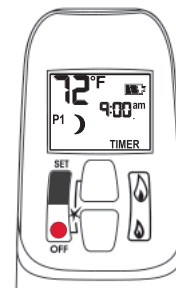

Set the different parameters when they are flashing.

## Using the Remote Control

### Circulating Fan Operation (if equipped)

Circulating fan has 4 speed levels from low to high (1 to 4 bars).

Press SET to scroll to . Fan and level icons flash.

To set speed, press flame buttons:

= increases speed.

= decreases speed and turns OFF fan when all bars disappear.

Note: 8 seconds after the fan is set, handset goes automatically in temperature control mode. Fan starts 4 minutes after gas opens (from OFF or pilot) at maximum speed then goes to displayed level after 10 seconds. Fan stops 10 minutes after gas is OFF or at pilot.

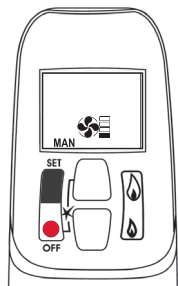

### Setting high / low Temperatures

#### Setting "DAYTIME" high temperature.

Default Settings: TEMP 23 °C/74 °F

Press SET to scroll to TEMP

Hold SET button until TEMP flashes.

To set Daytime Temperature:

= increases temperature.

= decreases temperature.

Press or wait to complete setting.

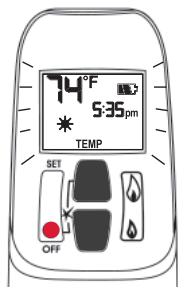

#### Setting "NIGHT TIME SETBACK" low temperature.

Default Settings: TEMP "--" (OFF)

Press SET to scroll to TEMP

Hold SET button until TEMP flashes.

To set Night Time Temperature:

= increases temperature.

= decreases temperature.

Press or wait to complete setting.

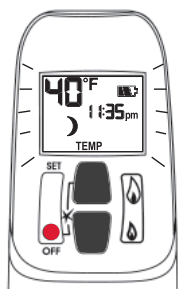

### Setting Program Timers

You can program two periods of time between 12 am and 11:50 pm in each 24-hour cycle.

Programs P1 and P2 must be set in the following order during a 24-hour cycle: **P1** , **P1** , **P2** and **P2** .

= Day Time temperature (high) program period

= Night Time temperature (low) program period

#### Default Settings:

Program 1: **P1** 06:00 am **P1** 08:00 am

Program 2: **P2** 11:50 pm **P2** 11:50 pm

Press SET to scroll to **TIMER**.



If **P1** = **P1** or **P2** = **P2** , programming is cancelled.

To keep fireplace ON all night, set **P2** at 11:50 am and **P1** at 12:00 am.

If you want to program only one period, program **P1** and **P1** with desired times then **P2** and **P2** with the same time as **P1**.

#### Setting P1 time - high temperature.

Hold SET button until **P1** is displayed and time flashes.

To set time:

= hour

= minutes

Press or wait to complete setting.

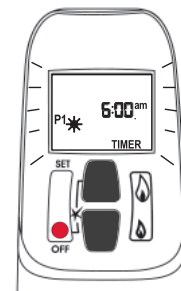

#### Setting P1 time - low temperature.

Hold SET button until **P1** is displayed and time flashes.

To set time:

= hour

= minutes

Press or wait to complete setting.

## Using the Remote Control

### Setting P2 high and low temperature times.

Repeat same steps as Setting P1.

When all settings are complete, press ● to save them.

### Timer Programming Example (default temperatures shown)

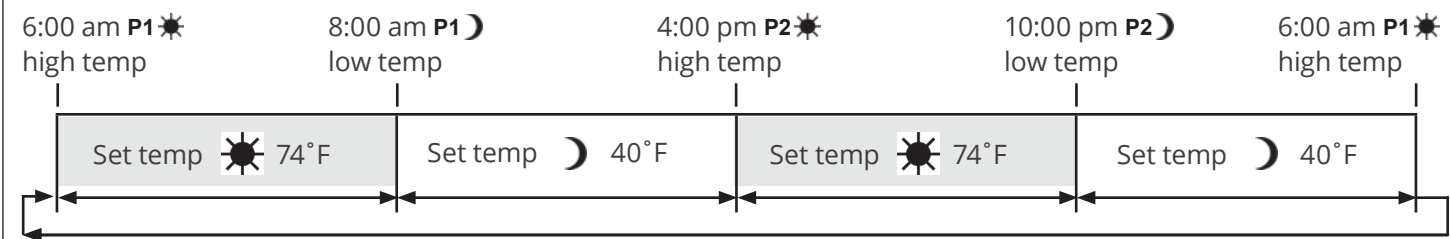

### Automatic Turn Down

#### 8 Hour no Motor Movement

The valve will turn to pilot flame if there is no motor movement for an 8-hour period.

### Automatic Shut-Off

**Low Batteries Receiver.** With low battery power in the battery holder the system shuts off the fire completely. This does not apply when the power supply is interrupted.

**On-Demand Pilot (7 Day Shut-Off).** This green feature eliminates gas energy consumption during extended appliance inactivity. When the appliance is inactive for an extended period of time the system automatically extinguishes the pilot. This feature helps the consumer realize cost benefits by automatically eliminating energy consumption during non-heating months and limited use.

The programmed length of inactivity to activate the system is specified by the appliance manufacturer and cannot be altered in the field.

### Low Battery Indication

#### Caution

DO NOT USE a screwdriver or other metallic object to remove batteries from holder. This could cause a short-circuit.

**Handset:** The battery icon  will show when the battery needs to be replaced. Replace with one 9 V **alkaline** battery.

**Battery holder:** Frequent 'beeps' for 3 seconds when the valve motor turns indicate the batteries need to be replaced in battery holder. Replace with four 1.5 V **alkaline** batteries.

### Handset / Receiver Match

The remote control handset and receiver are programmed to function together. In case of a replacement of the handset or the receiver, you will need to reset the receiver to allow them to function together. Contact your dealer for details.

## Kits & Accessories

### Required Kits

Information accurate at the time of printing and subject to change without notice.

<b>Liner Panels (choose one)</b>		
786LSLV3	Ledgestone panels	
787RGL	Reflective glass panels	
788FBLV2	Fluted black panels	
789VRLV2	Valor Red brick panels	
<b>Front &amp; Backing Plates (choose one)</b>		<b>Barrier Screen</b>
784EC	Edgemont Craftsman Fronts	4007655AZ
784ECBR	Bronze	
784ECPW	Pewter	
784ECCB	Champagne Brass	
790FTV	Floating Trim vintage iron	4003371
791	Square Trim Kits	4003371
791STB	Black	
791STV	Vintage iron	
791STP	Polished	
792	Floating Trim Kits	4003371
792FTB	Black	
792FTV	Vintage iron	
792FTZ	Bronze	
798	Floating 4-sided Trims	4003371
798FFB	Black	
798FFV	Vintage iron	
798FFZ	Bronze	
799ED	Edgemont Door Kits	4004348
799EDFZ	Bronze	
799EDFN	Nickel	
799BPB-1 799BPB-2 799BPB-3	Backing plates black for 784 & 799	

### Optional Accessories

Information accurate at the time of printing and subject to change without notice.

<b>Conversion Kits</b>	
785KNGK	Conversion to natural gas
785KPGK	Conversion to propane gas
<b>Other Accessories</b>	
785RGP	Reflective Glass Panel for 788FBLV2
793	Risers (2-1/2") for 790/1/2/8
794BPB 794BPB-1	Backing Plates Black for 790, 791, 792 & 798
795CFKV2	Circulating Fan Kit
796ALP	Adjustable Leveling Platform
1265WSK	Wall Switch Kit
RBWSK	Remote Battery & Wall Switch Kit
<b>Hearth Gate</b>	Hearth gates such as Cardinal's VersaGates are available at retail stores carrying safety products for children.

**FOR YOUR SAFETY, READ BEFORE LIGHTING**

**WARNING:** If you do not follow these instructions exactly a fire or explosion may result causing property damage, personal injury or loss of life.

- A. This appliance has a pilot which must be lighted by hand or by remote control. Follow these instructions exactly. To save gas, turn the pilot off when not using the appliance for a prolonged period of time.
- B. **BEFORE LIGHTING**, smell all around the appliance area for gas. Be sure to smell next to the floor because some gas are heavier than air and will settle on the floor.

**WHAT TO DO IF YOU SMELL GAS**

- Do not try to light any appliance.
  - Do not touch any electric switch; do not use any phone in your building.
  - Immediately call your gas supplier from a neighbor's phone. Follow the gas supplier's instructions.
  - If you cannot reach your gas supplier, call the fire department.
- C. Use only your hand to push in or turn the control knobs. Never use tools. If the knobs will not push in or turn by hand, don't try to repair them; call a qualified service technician. Force or attempted repair may result in a fire or explosion.
- D. Do not use this appliance if any part has been under water. Immediately call a qualified service technician to inspect the appliance and to replace any part of the control system and any gas control, which has been under water.

**LIGHTING INSTRUCTIONS**

Dependent on model, switch #1 may be mounted directly to valve see Fig 2A.

Fig 1

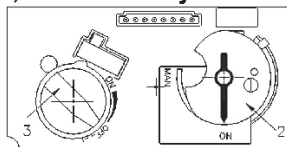
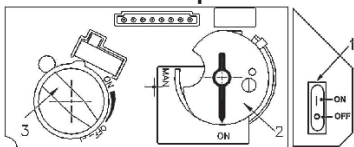

Fig 1A

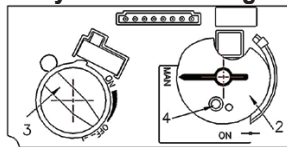

Fig 2

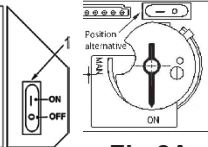



Fig 2A

1. **STOP!** Read the safety information above.
2. **SET ON/OFF SWITCH (1) TO "OFF" POSITION.**
  - Wait five (5) minutes to clear out any gas, then smell for gas, including near the floor. If you smell gas, **STOP!** Follow "B" in the safety information above on this label. If you don't smell gas, go to the next step.
3. **AUTOMATIC IGNITION (fig. 1):** Locate the pilot (fig 3.) inside of firebox.
  - ON/OFF switch (1) in ON position, MAN-knob (2) in ON position; set Flame Adjustment knob (3) to lowest setting (U)
  - On the remote control handset, press and hold the 'off' button and  (large flame) simultaneously; a short acoustic signal confirms the start has begun;
  - Further short acoustic signals indicate the ignition process is in progress;
  - When the pilot is lit, the Flame Adjustment knob (3) will automatically rotate to the highest setting.
  - Press the small flame on the remote control handset to reduce the flame height.
4. **MANUAL IGNITION (fig. 2):** With the window off, locate pilot (fig. 3) inside firebox;
  - ON/OFF switch (1) in ON position, MAN-knob (2) in MAN position;
  - Set Flame Adjustment knob (3) to the lowest setting (U);
  - Push down the metallic core (4) with a pen or similar instrument; this will establish the pilot gas flow; Light gas at the pilot (5) with a match;
  - Continue holding down metal core (4) for about 10 seconds; after release, pilot should remain lit;
  - If the pilot will not stay lit after several tries, turn the gas control knob (3) to "OFF" (U) and call your local service technician or gas supplier.

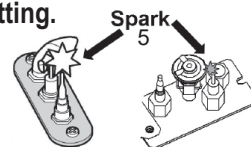

Fig 3

**TO TURN OFF GAS TO APPLIANCE**

**AUTOMATIC SHUT-OFF (using the remote control handset):**

1.
  - Press and hold the small flame on the remote control handset to shut-off the main burner gas flow;
  - Press "OFF" button (red dot) on remote handset to shut-off the appliance, including pilot flame.

**Servicing Your Fireplace**

We recommend having your fireplace serviced every year. Contact your supplier quoting the model number. It will be helpful if the appliance's serial number can also be quoted. These numbers are on the information card. The replacement parts are shown at the end of this manual. Please always quote the part number and description when requesting spare parts.

**Annual Inspection**

In order to maintain the safe operation of your fireplace, contact your dealer to have a qualified technician go over the list below and make the necessary verifications at least once every year.

**Safe Operation List**

To be performed by a qualified technician only

1. Inspect and operate the pressure relief mechanism to verify relief mechanisms are free from obstruction to operate. See *Cleaning Your Fireplace: To refit the window* section of this manual.
2. Clean glass window with a suitable fireplace glass cleaner. Abrasive cleaners must not be used. Be careful not to scratch the glass when cleaning. See *Cleaning Your Fireplace* section of this manual.
3. Inspect the operation of the flame safety system Pilot or Flame rectification device.
4. Inspect and ensure the lighting of the main burner occurs within 4 seconds of the main gas valve opening. Visual inspection should match that outlined in the appliance instruction manual. Inspect primary air openings for blockage. See *Checking Pilot and Burner Flame* section of this manual.
5. Inspect condition of vent and vent terminal for sooting or obstruction and correct if present.
6. Vacuum and clean any debris in the firebox that is not supposed to be there.
7. Test and measure the flame failure response time of the flame safety system. It must de-energize the safety shutoff in no more than 30 seconds.
8. Check all accessible gas-carrying tubes, connections, pipes and other components for leaks. See *Set up Gas Supply* section of this manual.

### Cleaning Your Fireplace

#### **⚠ WARNING**

**DO NOT TOUCH THE GLASS WHILE IT IS HOT!**  
Let the fireplace cool first before cleaning it.

#### **Important - Glass cleaning - Mineral deposits**

One of the by-products of the combustion process in a gas appliance is a mineral which can show up as a white film on the ceramic glass of the viewing door.

The composition of the deposit varies with location and time. It is believed to be associated with the varying sulfur content of the gas. You may have the problem intermittently.

We have consulted with ceramic glass manufacturers and they cannot offer a definitive solution to this problem. Dealers have tried various cleaning products with varying results. The following are recommendations only and are not meant to guarantee results.

**NOTE: This is a problem beyond Miles Industries' control and is not covered under warranty.**

- Clean the glass regularly as soon as you notice the buildup (white film). If the film is left for a longer period of time, it will etch into the glass. It is then much harder, if not impossible, to remove.
- **NEVER use an abrasive cleaner or ammonia-based cleaner on the ceramic glass.** Any abrasion of the surface has the immediate effect of compromising the strength of the glass. An emulsion type cleaner is recommended.
- Use a soft damp cloth to apply the cleaner. Dry the glass with a soft, dry, preferably cotton cloth. Most paper towels and synthetic materials are abrasive to ceramic glass and should be avoided.
- Our dealers have had good results from the products listed below. We cannot, however, guarantee the results of these products.
  - Brasso, Polish Plus by Kelkem, Cook Top Clean Creme by Elco, White Off by Rutland, Turtle Wax

#### **Do not clean the glass while it is hot!**

Always securely replace the window and the barrier screen before lighting.

**If broken, the glass pane may only be replaced as a complete window unit as supplied by the manufacturer.**

**If the barrier becomes damaged, the barrier shall be replaced with the manufacturer's barrier for this appliance.**

Clean the window panes following the guidelines in this section.

Clean the steel trim with mild soap and warm water. Any alcohol/solvent base cleaner will weaken the coating and damage it.

Clean the barrier screen dusting it with a soft brush.

Clean the firebox ceramic logs/rocks and walls dusting them with a soft brush. Dust can also be removed from the burner using a soft brush after removing the fuel bed. **When cleaning, make sure that no particles are brushed into the slots of the burner.**

#### **To remove the window for cleaning:**

1. Unhook the trim with the barrier screen.
2. Remove the side access doors as indicated.

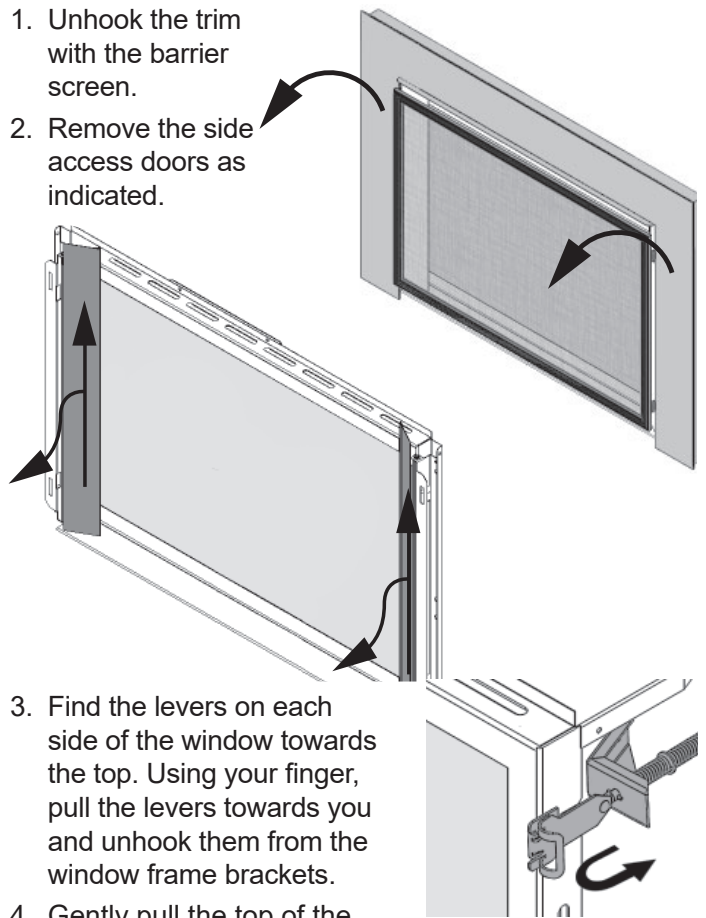

3. Find the levers on each side of the window towards the top. Using your finger, pull the levers towards you and unhook them from the window frame brackets.
4. Gently pull the top of the window outward.
5. Lift the window out of its bottom railing and set it aside in a safe place to avoid damage.

To refit the window:

**⚠ DANGER**

The window unit must be correctly installed, fastened and sealed after servicing or serious bodily injury and/or damage to the appliance may result.

To ensure a safe operation:

- Double-check that the bottom of the window frame is correctly installed in the bottom support railing;
- Verify that the levers are hooked properly to the window tabs then;
- Pull out the top of the window and release it to insure the springs return it;
- Ensure the window is sealed before operation.

**⚠ WARNING**

Failure to install the window correctly can leak carbon monoxide, affect the performance of the fireplace, damage components, cause overheating resulting in dangerous conditions. Damage caused by incorrect window installation is not covered by the Valor warranty.

1. Place the window in its bottom railing and push its top against the firebox. **Ensure to remove any coal particles in the railing before installing the window.**

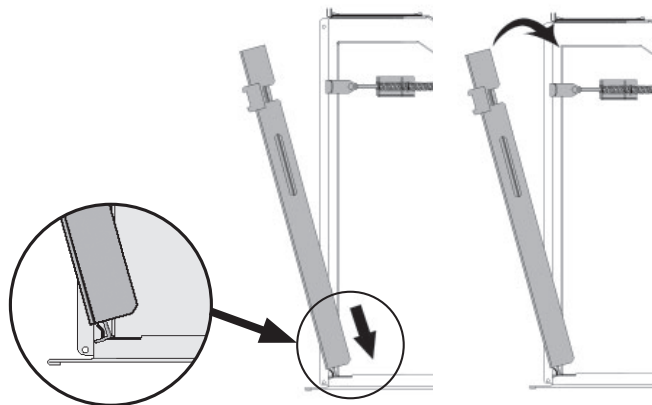
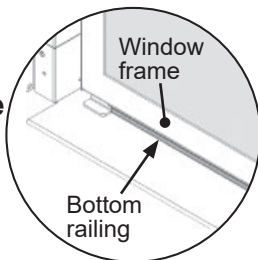

2. While you hold it, unhook the side levers from the trim supports and hook them into the window tabs.

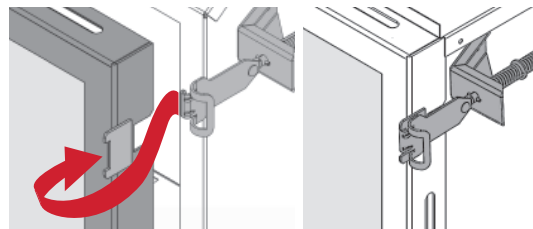

3. Pull out the top of the window and release it to ensure the springs return it.
4. Apply firm hand pressure around the window frame to ensure the window is sealed tight against the firebox.
5. If the Hot Glass Warning plate has been removed from the front lower corner of the window, reinstall it by sliding it between the glass and the frame as indicated.

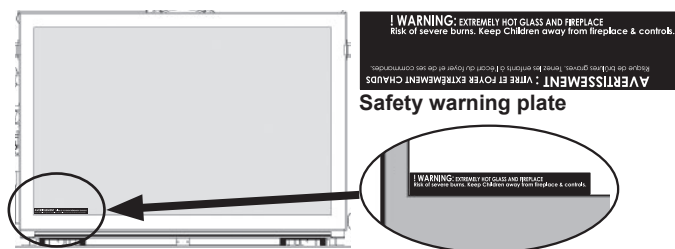

6. Reinstall the access side doors to the fireplace.
7. Rehook the front trim fitted with the barrier screen.

**⚠ WARNING**

**FOR SAFETY PURPOSE**, ensure the barrier screen is re-installed on the fireplace front after maintenance.



## Servicing & Maintenance

### Checking Pilot and Burner Flames

A periodic check of the pilot and burner flames should be made. Check after the fire has been on for at least 30 minutes. The pilot flame must cover the tip of the thermocouple probe. The main burner flame pattern will vary from appliance to appliance depending on the type of installation and climatic conditions.

#### Correct Flame Appearance

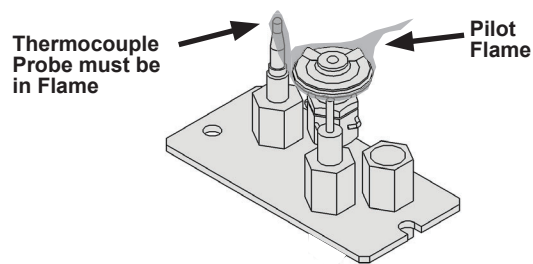

The appliance area must always be kept clear and free from combustible materials, gasoline and other flammable vapors and liquids.

Inspect the vent terminal outdoors regularly to make sure that dirt, snow, insects, leaves, shrubs, trees do not obstruct it.

Examine the whole vent system regularly. We recommend annually.

**Replacing Batteries**

**⚠ WARNING**

**DO NOT ATTEMPT TO CHANGE THE BATTERIES WHILE THE FIREPLACE IS STILL HOT!** Let the fireplace cool first before touching it.

**CAUTION**

**DO NOT USE** a screwdriver or other metallic object to remove the batteries from the battery holder or the handset! This could cause a short circuit to the receiver.

**Low battery signal: see page 11.**

**BEFORE** changing the batteries, disconnect the battery holder from the receiver.

The appliance uses four 1.5 V AA **alkaline** batteries for its battery holder and one 9 V **alkaline** battery for its handset. Batteries should last one to two seasons, depending on usage. Removing the batteries in the off-season will extend the battery life. Should the batteries lose power, the control may be operated by manually turning the control knob at the valve or by turning off the valve at the switch.

**To replace the batteries in the battery holder:**

1. The battery holder is located to the left of the firebox behind the left access door. Remove the left access door. Grab the battery holder and pull it out from its location.

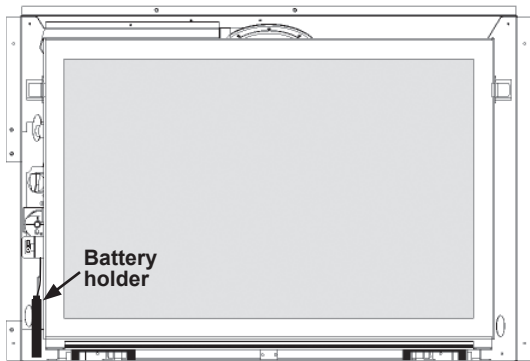

2. Disconnect the battery holder.



3. Replace the batteries with 4 AA **alkaline** batteries.
4. Reconnect the battery holder.
5. Put the battery holder back in its position.
6. Reinstall the left access door.

**Using Handset Wall Holder**

Your fireplace equipment includes a wall holder to store the handset. If it hasn't been installed, refer to the instructions further on in this manual for the installation.



# Specifications

## Approval & Codes

This appliance is certified to ANSI Z21.88 / CSA 2.33 American National Standard / CSA Standard for *Vented Gas Fireplace Heaters* for use in Canada and USA, and to CGA 2.17-91 *High Altitude Standard in Canada*. This appliance is for direct vent insert installations.

This appliance complies with CAN/CSA P.4.1-15 *Testing method for measuring annual fireplace efficiencies*.

The installation must conform to local codes or, in the absence of local codes, with the *National Fuel Gas Code, ANSI Z223.1/NFPA 54* or the *Natural Gas and Propane Installation Code CAN/CGA-B149.1*. Only qualified licensed or trained personnel should install this appliance.

This appliance must be electrically grounded in accordance with local codes, or, in the absence of local codes, with the *National Electrical Code, ANSI/NFPA 70* or the *Canadian Electrical Code, CSA C22.1*.

## Ratings

### \*High Altitude Installations

Model	KLN	KLP
Gas	Natural	Propane
Altitude (Ft.)*	0-4,500 feet*	
Input Maximum (Btu/h)	28,000	28,000
Input Minimum (Btu/h)	17,500	13,000
Manifold Pressure (in w.c.)	3.2	10.5
Minimum Supply Pressure (in w.c.)	5.0	11.0
Maximum Supply Pressure (in w.c.)	10.0	14.0
Main Burner Injector Marking	850	300
Pilot Injector Marking	51	30
Min. Rate By-Pass Screw	220	125

Input ratings are shown in BTU per hour and are certified without deration for elevations up to 4,500 feet (1,370 m) above sea level.

For elevations above 4,500 feet (1,370 m) in USA, installations must be in accordance with the current ANSI Z223.1 and/or local codes having jurisdiction. Heating value of gas in some areas is reduced to compensate for elevation—consult your local gas utility to confirm.

For installations at elevations above 4,500 feet

(1,370 m) in Canada, please consult provincial and/or local authorities having jurisdiction.

## Supply Gas

Heater engine 785KLN is used with natural gas. Heater engine 785KLP is used with propane gas. The supply pressure must be between the limits shown in the Ratings section above.

The supply connection is 1/2" NPT female and located on the left hand side of the control valve. The gas line entry point is on the upper left hand side on the fireplace.

## Conversion Kits

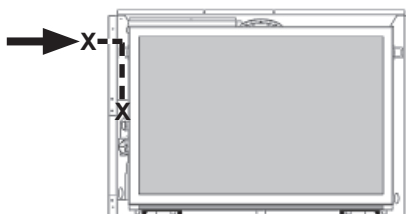

The 785 Legend G4 is supplied as natural gas or propane gas and is field convertible between fuels. See instructions packaged with the conversion kit for further information.

## Electrical

The 785 does not require an electrical power source to operate as a heater. However, if the appliance is fitted with a fan, a grounded power source is required.

## Floor/Hearth

This appliance is approved for installation into existing solid-fuel burning fi replaces only. Combustible material such as plywood and so on may be used for leveling and shimming beneath the unit. This appliance does not require a hearth other than to support the weight of certain fronts.

**This appliance is designed and approved as a supplemental heater and provides the potential for most energy conservation when used while attended. The use of an alternate primary heat source is advisable.**

**This appliance may ONLY be installed in an existing unaltered, functioning solid-fuel burning fireplace with a working flue and constructed of non-combustible material.**

**DO NOT install into combustible construction. This appliance is NOT APPROVED for installation with a zero clearance kit.**

**⚠ WARNING**

Some materials or items, although safe, may discolor, shrink, warp, crack, peel, and so on because of the heat produced by the fireplace. Avoid placing candles, paintings, photos, and other items sensitive to heat around the fireplace.

**⚠ WARNING**

**HOT HEARTH / FLOOR!** The hearth or floor in front of the fireplace may become very hot when the fireplace heats. Do not use the hearth as a seat or shelf. Solid wood flooring in front of the fireplace (if allowed) may shrink during the heating season due to heat.

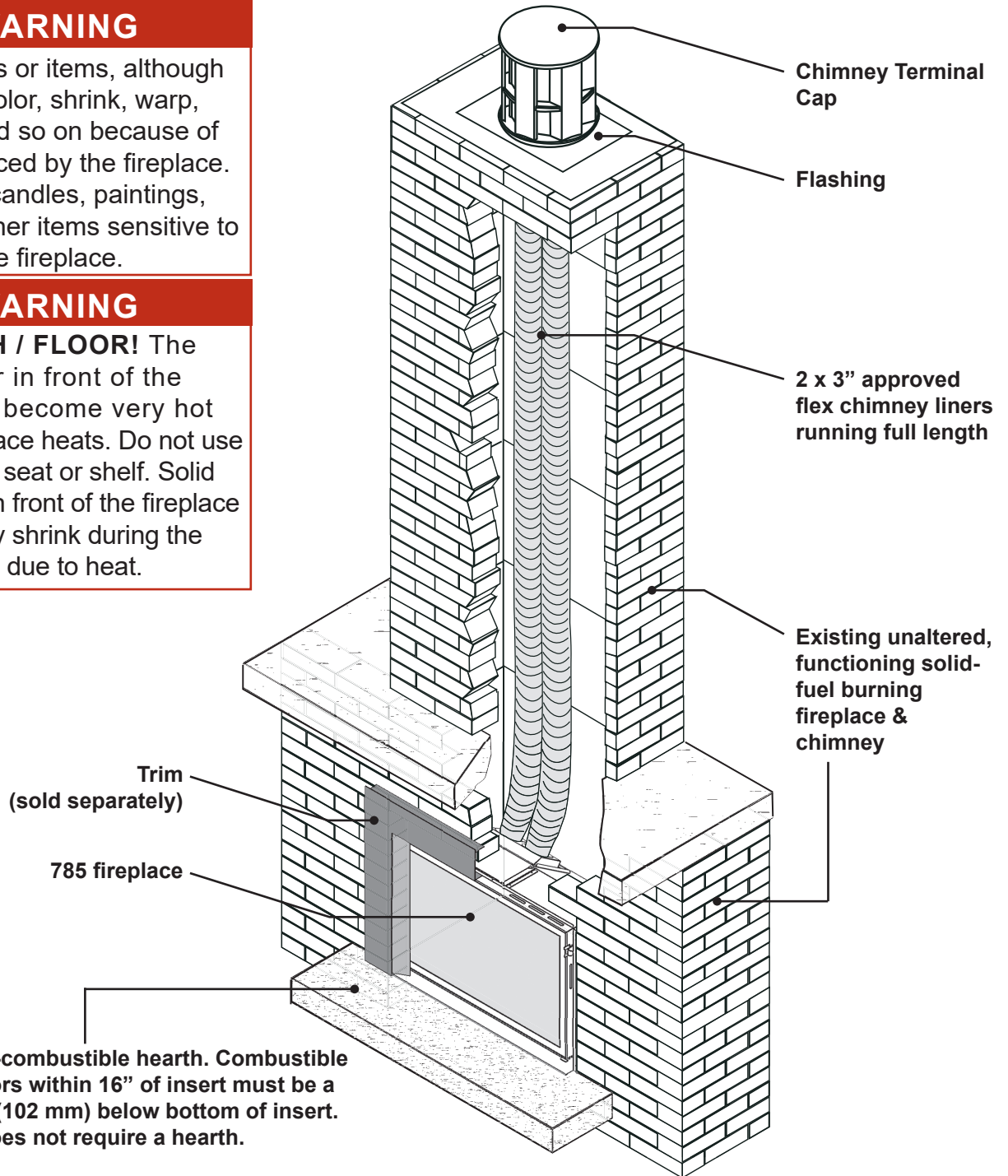

## Dimensions

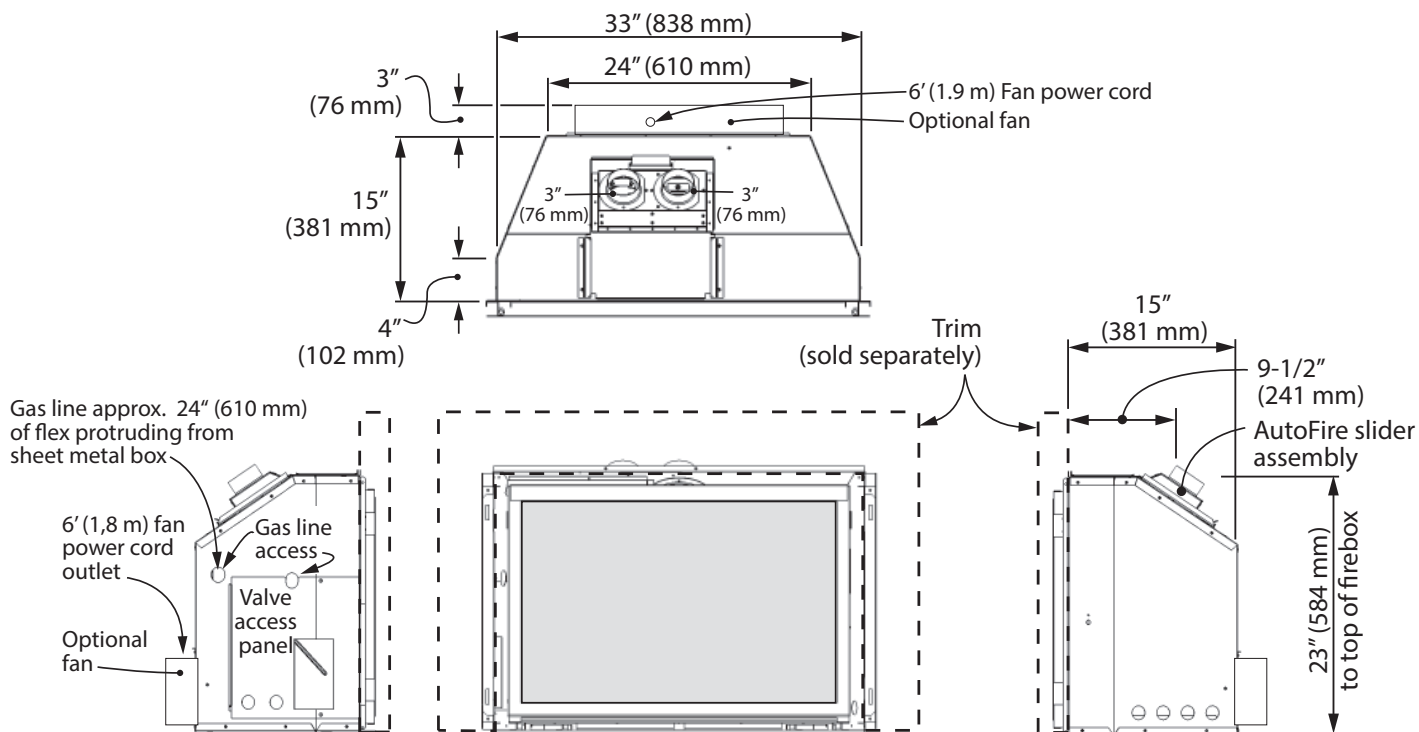

## Cavity

Check that masonry step does not interfere with install dimensions or vent pipe.

If mantel is combustible, see following section for allowable clearances.

A hearth that is at a height within 4" (102 mm) of the bottom of the heater **MUST** be non-combustible.

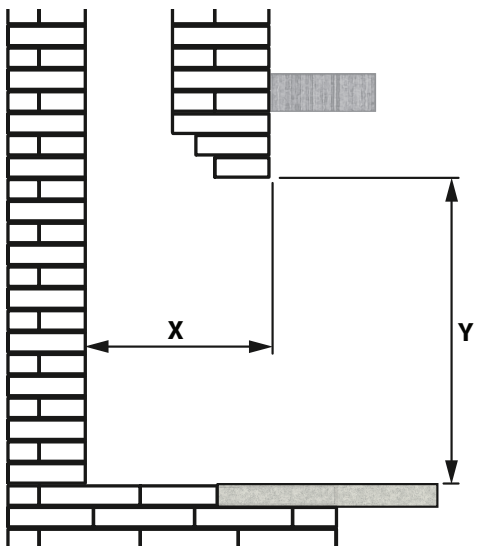

### Minimum Cavity Dimensions

	all trims <b>except</b> 799 Edgemont Door			with 799 Edgemont Door Kit	
	standard install	w/796 leveling platform	w/795 fan kit	no fan	w/795 fan
<b>Width</b> (minimum fireplace opening at front)	33-1/4" (855 mm)	33-1/4" (855 mm)	33-1/4" (855 mm)	35-3/4" (908 mm)	
<b>Depth X</b>	15-1/2" (394 mm)	16" (406 mm)	18-1/2" (470 mm)	16-3/4" (426 mm)	19-3/4" (502 mm)
<b>Height Y</b>	23-1/4" (591 mm)	23-1/4" (591 mm)	23-1/4" (591 mm)	23-3/4" (603 mm)	

## Clearances

### ⚠ WARNING

Some materials or items, although safe, may discolor, shrink, warp, crack, peel, and so on because of the heat produced by the fireplace. Avoid placing candles, paintings, photos, and other items sensitive to heat around the fireplace.

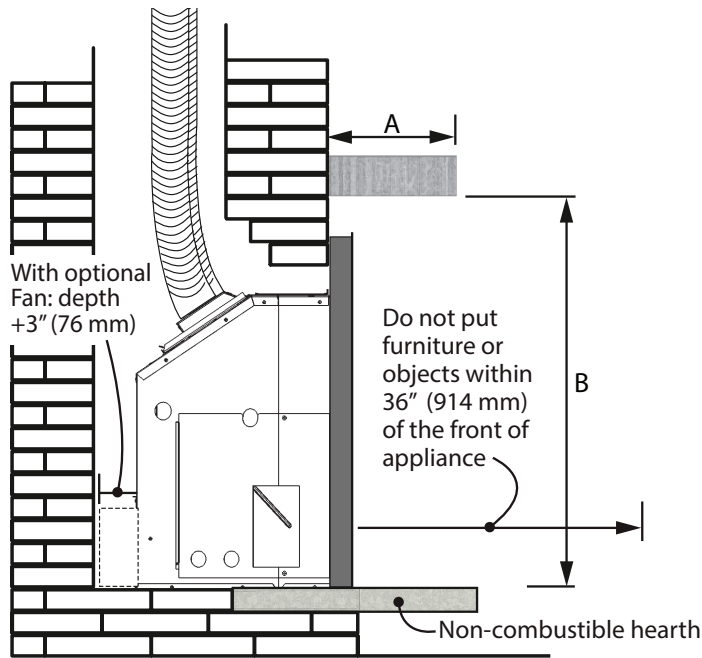

### Combustible Mantel Clearances

Mantel Pro- jection A	1" (25 mm)	4" (101 mm)	8" (203 mm)	14" (355 mm)
Mantel Height B*	34" (864 mm)	36" (914 mm)	38" (965 mm)	40" (1016 mm)

\*Measure taken from the underside of the mantel to finished hearth or surface that the unit is sitting on.

### Finishing Materials

**Combustible materials:** Materials made of or surfaced with wood, compressed paper, plant fibers, plastics, or other material that can ignite and burn, whether flame proofed or not, or plastered or unplastered.

**Non-combustible materials:** Material which will not ignite and burn. Such materials are those consisting entirely of steel, iron, brick, tile, concrete, slate, glass or plasters, or any combination thereof.

Materials that are reported as passing ASTM E 136, Standard Test Method for Behavior of Materials in a Vertical Tube Furnace at 750 °C

### ⚠ WARNING

**HOT GLASS!** The use of a screen in front of the glass is highly recommended particularly in households with children.

### ⚠ WARNING

**HOT HEARTH / FLOOR!** The hearth or floor in front of the fireplace may become very hot when the fireplace heats. Do not use the hearth as a seat or shelf. Solid wood flooring in front of the fireplace (if allowed) may shrink during the heating season due to heat.

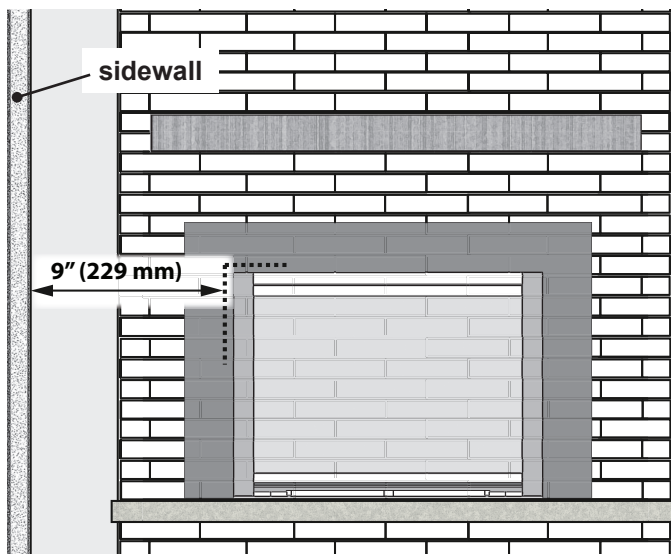

### Sidewall Clearances

**Minimum** distance from side of appliance (liner box) to combustible wall: 9" (229 mm).

Mantel legs projecting forward less than 6" (152 mm) may be located within 5" (127 mm) of the side of the appliance (liner box).

### Floor/Hearth Clearances

Combustible shims/supports may be used beneath the appliance to level or raise the appliance within the existing fireplace cavity.

Combustible flooring/hearths **in front** of the appliance must be at a minimum of 4" (102 mm) below the bottom of the appliance. The gas insert does not require a hearth.

## Typical Vent Installation

See list of approved venting accessories on page 39 of this manual.

**NOTE: Flexible co-linear vent pipes may only be installed into existing non-combustible solid-fuel burning fireplaces and chimneys.**

## Vent Location

The vent terminal must be located through the roof. This direct vent appliance is designed to operate when an undisturbed airflow hits the outside vent terminal from any direction.

Check local codes for allowable vertical vent termination.

## Venting Table

Maximum vertical height	40 ft (measured to bottom of termination)
Minimum vertical height	10 ft (measured to bottom of termination)
Maximum horizontal run	4 ft (measured center to center of pipe)
Maximum offset angle	45° (sweeping bend to allow for obstructions)

## Venting Notes

Where possible, avoid joining flex pipes. If joints are required, use a approved connector and seal joints with *RTV high temp sealant*.

Horizontal offset is permissible to allow for routing around masonry projections. Avoid bending flex pipe over a 45 degrees radius where possible.

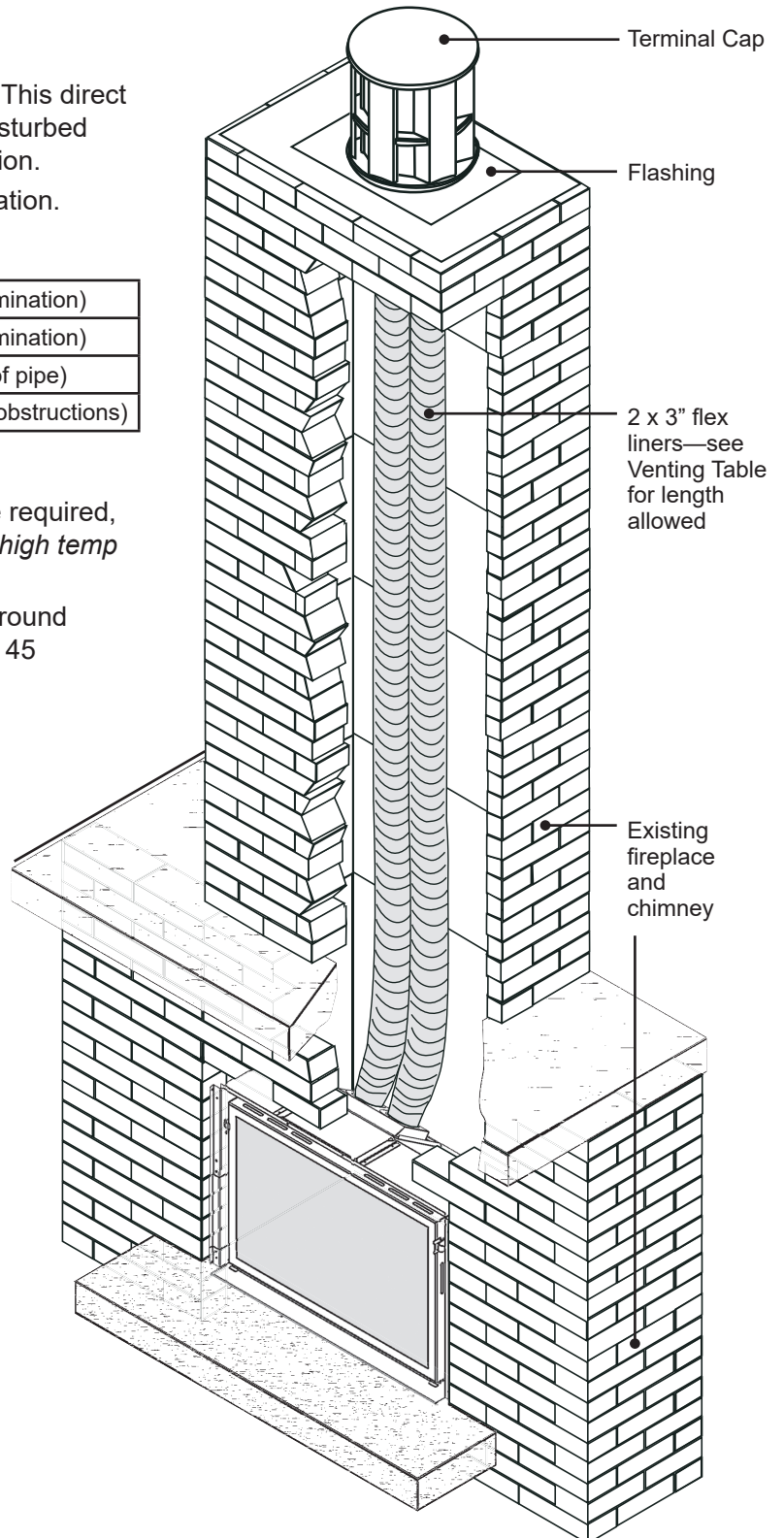
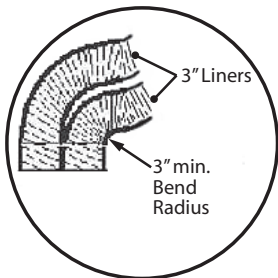

**Only qualified licensed or trained personnel should install this appliance.**

## Installer—READ THIS FIRST

1. **YOU NEED TO KNOW FROM THE HOMEOWNER** what accessories (surround, screen, fan/blower, etc.) will be installed with this fireplace;
2. Unpack the appliance.
3. Check that you have everything.
4. Clean cavity, chimney, ash dump, and clean-out.
5. Install venting pipes.
6. Attach conversion plate to existing fireplace.
7. Remove window.
8. Install electrical wiring for fan if used.
9. Install and test fan if used.
10. Fit appliance into cavity.
11. Connect and test gas supply.
12. Install ceramic panels and fuel bed.

13. Refit window.
14. Reinstall the hot glass warning plate if it has been removed.
15. Put batteries in remote control handset and battery holder. Connect battery holder.
16. Set-up remote control.
17. Verify operation and adjust aeration settings.
18. Install the remote control handset wall holder.
- 19. Instruct the homeowner on the operation and maintenance of the fireplace.**
20. Install the trims and screen.

\*If installing a fan, you will need to use the remote control to test the fan operation. In this case, put batteries in the handset and the battery holder and set up the remote control.

## Existing Fireplace Preparation

A few points must be considered before inserting the 785 into an existing fireplace cavity. Generally, no modifications are allowed to the existing fireplace that will compromise the integrity of the existing fireplace.

Components that are bolted or screwed on such as dampers or baffles may be removed to accommodate the installation of the 785 engine. **Cutting away any sheet metal parts of the existing fireplace to accommodate the installation of the 785 is prohibited.** Check with local authorities if in doubt.

### Clean Fireplace and Chimney

Have the chimney swept and the fireplace cavity including ash dumps and clean-outs cleaned before installing the 785 heater and vent liners. Any creosote or soot residue remaining in the fireplace cavity chimney or clean-out may cause odors or stains once the 785 insert is installed. Consult with chimney sweep for information on how best to clean.

### Existing Dampers

Factory-built, zero-clearance fireplaces will require the damper to be removed in order to install the vent liners. These dampers are usually bolted into place. Dampers in masonry fireplaces must be fixed open and may remain in place.

### Ash Retaining Curbs

Some fireplaces (particularly factory-built) have a raised curb at the front edge to retain ashes. Check the dimensions carefully to ensure the 785 engine will fit behind any raised curb (some curbs may be removed separately from the refractory base).



## Existing Fireplace Preparation

### Gas Line Routing

Plan the routing of the gas line before proceeding. Utilize the existing hole for the gas line of the factory-built fireplace.

If the fireplace has no access hole, carefully drill an access hole of 1.5 inch (38 mm) or less through the lower sides or bottom of the firebox. The access hole must be plugged with non-combustible insulation after the gas supply line has been installed.

See *Dimensions* section for detailed location of gas inlet. Also, take into consideration whether or not a fan or shut-off valve will interfere when planning routing of the gas line.

### Existing Glass Doors and Wire Screens

**Existing glass doors must be permanently removed** prior to installing the 785 insert.

### Combustible Mantels

Combustible mantel clearances must conform to those required for the original solid-fuel fireplace into which the 785 is being installed.

### Attach Warning Conversion Plate to Existing Fireplace (plate supplied loose with 785 heater)

Attach the “This fireplace has been converted...” label to the existing fireplace using screws or other mechanical means and store any removed parts in back of the existing fireplace for future use.

## Installation

### Unpack the appliance

**Beware of sharp edges! Wear gloves!**

1. Unpack the appliance.
2. Unpack any loose items from around the appliance and check against the Pack Content list provided in the documentation package.
3. Remove the window and set aside in a safe place to avoid damage—see next page.
4. **Verify that you have all the components required for the installation, including:**
  - *ceramic panels and logs;*
  - *trim;*
  - *venting components and accessories;*
  - *fan and electrical components for its installation if used.*

## Installation

### Remove Window

The window is held in place by a spring-loaded lever on each side.

1. To remove the window, locate the levers on each side of the window towards the top. Using your finger, pull the lever towards you and unhook it from the window frame bracket.
2. Gently pull the top of the window outward.
3. Lift the window out of its bottom railing and set it aside in a safe place to avoid damage.

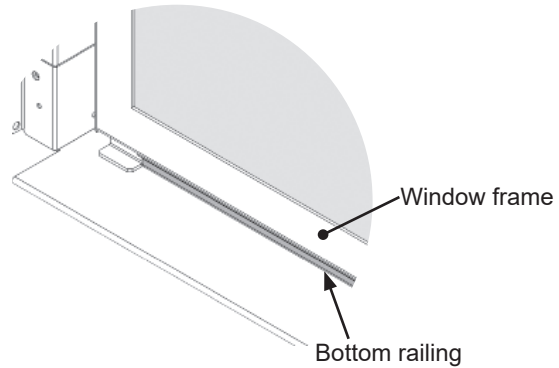

### Section Views

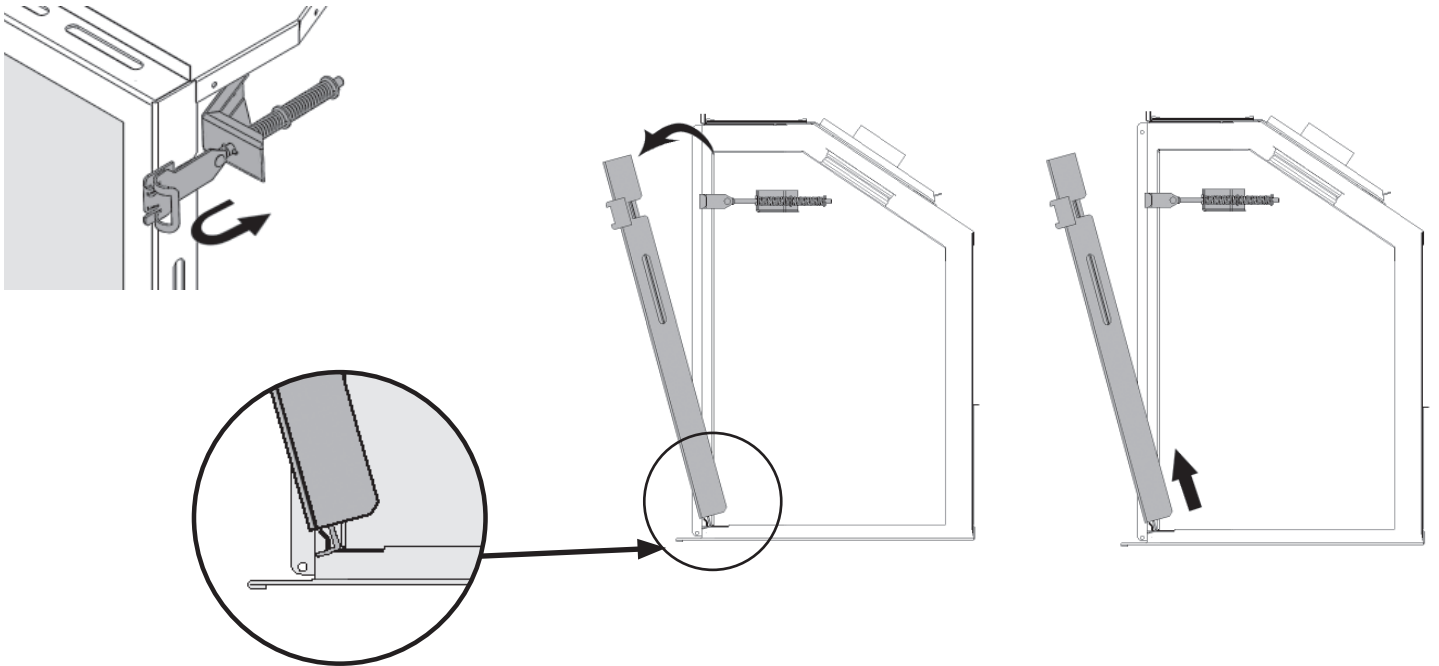

### Install Fan (if used)

If the 795CFKV2 Circulating Fan Kit (blower) is to be installed, we suggest that you do it now.

The fan cavity is accessible from the back of the firebox to facilitate its installation. If the fan is retrofitted after the installation of the appliance, the appliance will need to be removed. Therefore, we recommend that, where possible, the fan be installed before the appliance is fitted into the cavity.

Refer to instructions provided with the 795CFKV2 to install the fan.

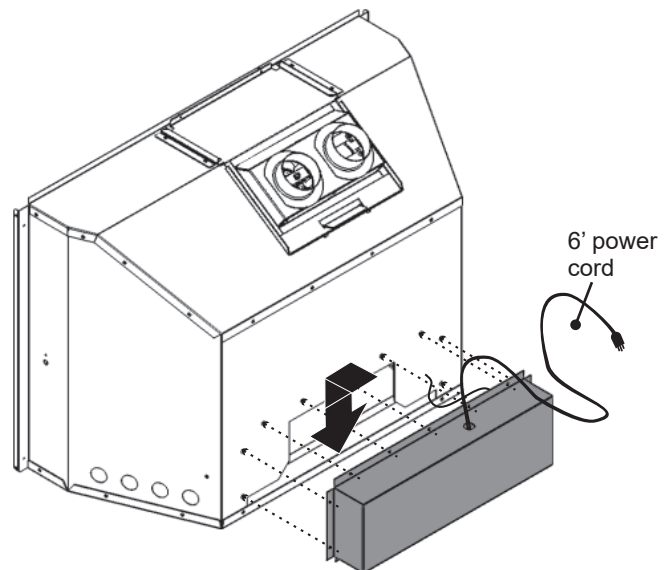

## Connect Venting

**IMPORTANT:** This appliance's venting system is room sealed and therefore, does not require room air to be used in the combustion process.

1. Rough-in two 3" diameter vent liners into the existing chimney system from the roof. Be careful not to tear or damage the liners in the process. It may be easier to install both liners at the same time rather than one at a time. Leave plenty of liners at the bottom to facilitate the connection of the liners to the vent slider. **It is best to leave the top termination until later.** Designate and mark the top and bottom of one liner as "EXHAUST" to avoid confusion later.
2. Release the two screws retaining the vent slider to the front of the firebox. Remove the slider from the firebox by sliding it towards the back of the firebox.
3. Fit the two liners ensuring that the **exhaust liner is connected to the identified "EXHAUST" vent collar**. Secure liners to collars with hose clamps (included) and 2 tapping screws per liner.
4. Slide the firebox onto the vent slider in the cavity taking care not to damage the liners. **Make sure that the rear edge of the slider is hooked over the cleat on the firebox.** Secure the vent slider to the front of the firebox with two screws removed earlier.
5. From the roof, pull the liners and fit the flashing.
6. Fit the terminal cap ensuring that the **exhaust liner is connected to the exhaust vent collar**. Secure with screws.
7. Seal the terminal and flashing from water penetration as required.

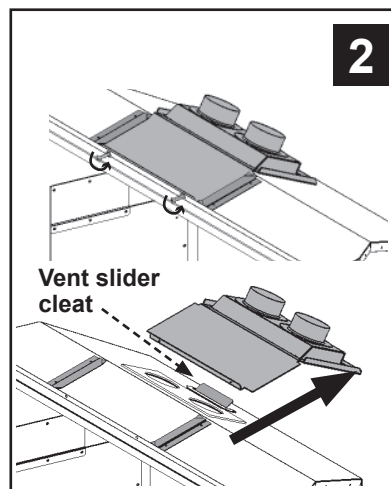

**2**

**4**

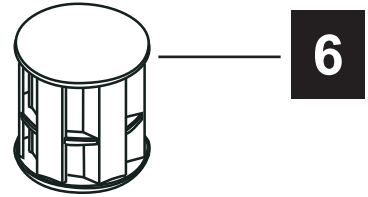

**6**

**7**

**5**

**1**

**3**

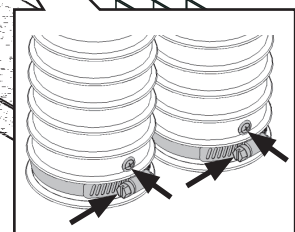

**⚠ WARNING**  
Failure to position the parts in accordance with these diagrams or failure to use only parts specifically approved with this appliance may result in property damage or personal injury.

## Installation

### Connect Gas Supply

The gas supply inlet connection is a 1/2" NPT female. Gas shut-off valve supplied on the end of stainless steel flexible connector. Flex connector is located on the left hand rear corner of the appliance.

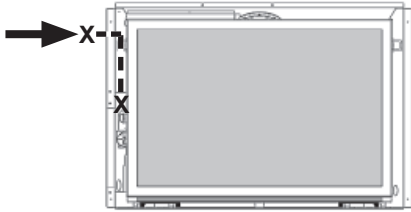

Use only new black iron or steel pipes, CSST, or copper tubing if acceptable—check local codes. Note that in USA, copper tubing must be internally tinned for protection against sulfur compounds.

The burner module and gas train on this appliance may be removed as a unit for servicing. The flex pipe supplied with the unit provides a union for removal of the module.

Unions in gas lines should be of ground joint type.

The gas supply line must be sized and installed to provide a supply of gas sufficient to meet the maximum demand of the appliance without undue loss of pressure.

Sealant used must be resistant to the action of all gas constituents including LP gas. Sealant should be applied lightly to male threads to ensure excess sealant does not enter gas lines.

Pressure test the supply line for leaks.

The appliance and its individual shut-off valve must be disconnected from the gas supply piping system during any pressure testing of that system at test pressures in excess of 1/2 psig (3.5 kPa).

The appliance must be isolated from the gas supply piping system by closing its equipment shut-off valve during any pressure testing of the gas supply piping system at test pressures equal to or less than 1/2 psi (3.5 kPa).

Failure to either disconnect or isolate the appliance during pressure testing may result in regulator or valve damages and void the warranty. Consult your dealer in case of damages.

### Pressure Test Points

The minimum supply pressure is given in the section *Specifications* of this manual—page 19.

All piping and connections must be tested for leaks after installation or servicing. All leaks must be corrected immediately.

When testing for leaks:

- Make sure that the appliance is turned off.
- Open the manual shut-off valve.
- Test for leaks by applying a liquid detergent or soap solution to all joints. Bubbles forming indicate a gas leak.

**Never use an open flame to check for leaks.  
Correct any leak detected immediately.**

The pressure test tapping locations is shown in the figure below. An internal regulator within the valve controls the burner manifold pressure.

The correct pressure range is shown in the table in section *Specifications* of this manual on page 19. The pressure check should be made with the burner light and at its highest setting. See *Lighting Instructions* section for full operating details on page 13.

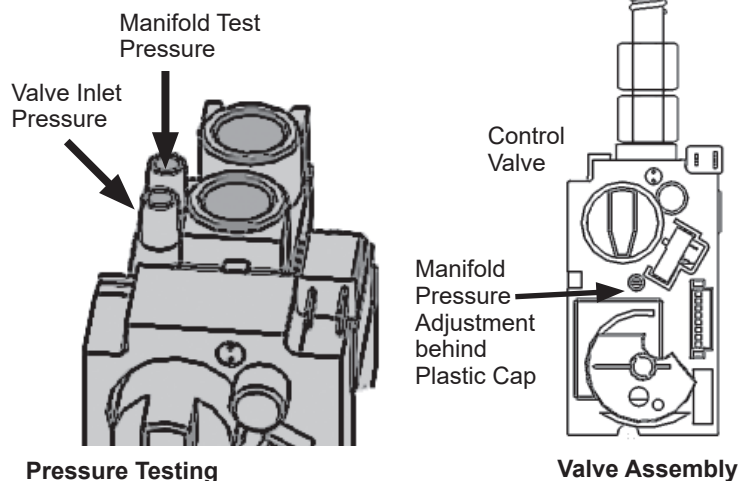

# Installation

## Alternate Inlet Connection

In cases where local codes do not permit the flex connector to be used inside the appliance case, reconnect the flex connector outside of the appliance case. A cut-out is provided in the appliance case for this purpose.

Use common elbow and fittings (not supplied) to redirect the position of the flex connector. **NOTE:** the flex connector bend radius must be no smaller than the size of a golf ball (approx. 1-3/4" or 44 mm).

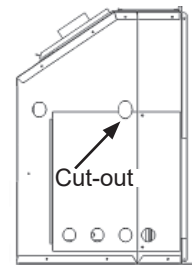

1. Remove flex connector.

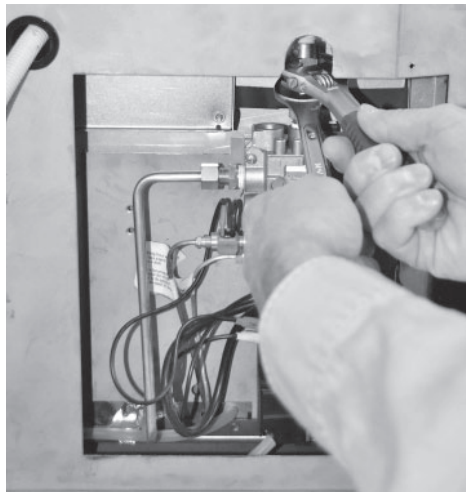

2. Remove flared connector.



3. Install new inlet elbow.

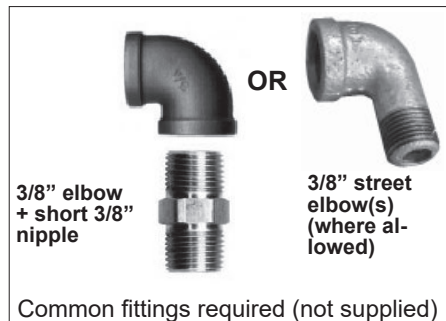
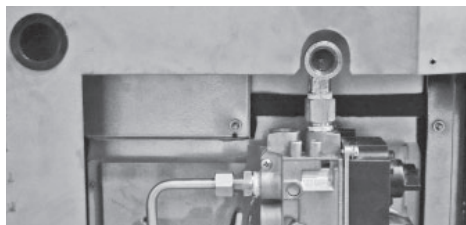

### Option 1

4. Add flared connector to new elbow and fit flex connector. Close the access panel.

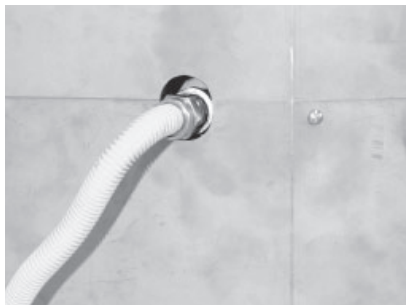

Flex connector redirected using one elbow.



Top view, left side



Front view, left side

### Option 2

4. Add another elbow, the flared connector and refit the flex connector. Direct it towards the rear of the appliance or downward. Close the access panel.

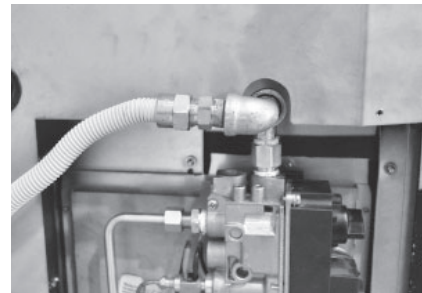

Flex connector redirected using two elbows.

## Installation

### Remove and re-install burner (if necessary)

The ceramic panels can be installed without removing the burner. However, you can remove the burner for additional space if desired.

1. Remove the 2 screws fixing the rear of the burner to the manifold bracket as indicated. Do not remove the air shutter screws.

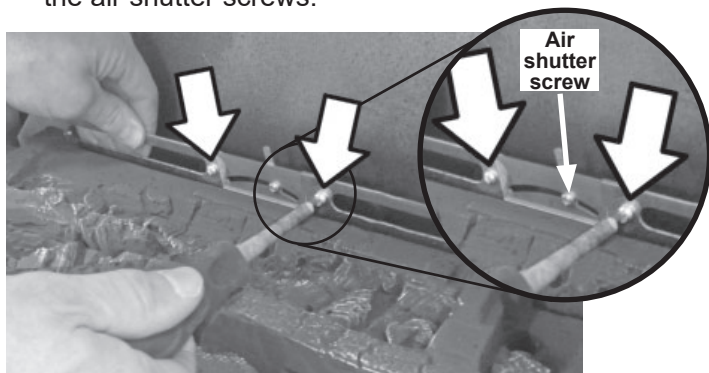

2. Grab the burner as indicated and gently pull up the rear first and then the front. **Be careful not to hook the pilot hood as you pull the burner up.**

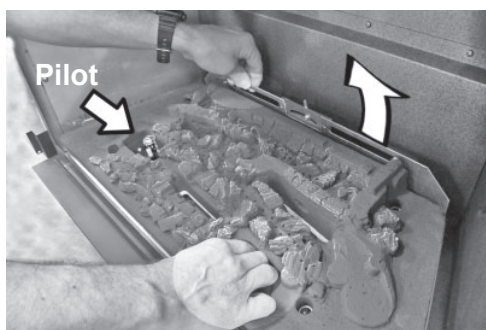

3. To reinstall the burner, fit the burner in the firebox inserting the front first. **Again, be careful not to hook the pilot hood when fitting the burner over the pilot.** Fix the burner to the manifold bracket at the rear with 2 screws.

### Install Liner Panels

The following guidelines apply to all panels except 787RGL Reflective Glass Liners for which separate instructions are provided with the kit. You do not need to remove the burner to install the panels unless you wish to install the 785RGP Reflective Glass Panel—see instructions provided with the Glass Panel.

1. Inside the firebox, on the top of each side, release the screw of the side panel anchors (one per side) just enough to allow them to rotate.

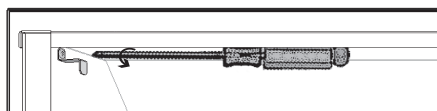

2. Place the rear panel against the back of the firebox, on the ledge at bottom, behind the burner.

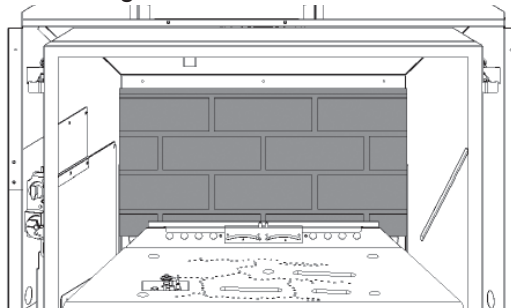

3. Rotate the anchor up and out of the way and slide the left hand side panel against the firebox side. Rotate the anchor back down to hold the panel.
4. Rotate the anchor up and out of the way and slide the right hand side panel against the firebox side. Rotate the anchor back down to hold the panel.

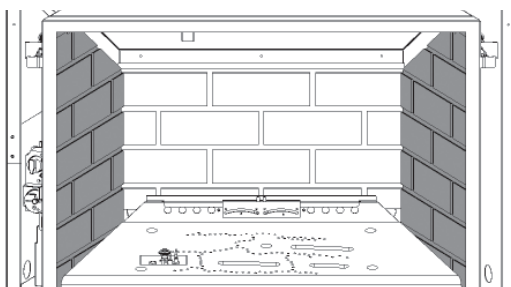

5. Tighten the side panel anchors on each side of the firebox.

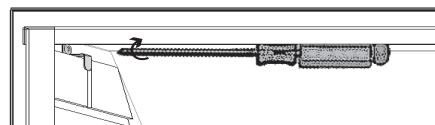

6. Install the top panel supporting it with the back and side panels.

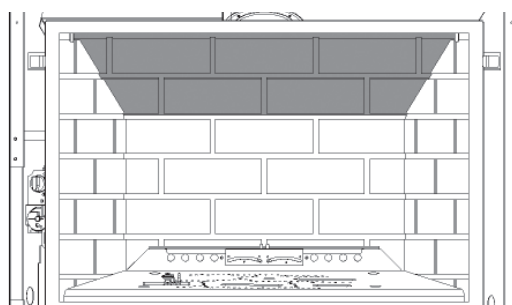

7. Discard the front bricks as they are not required on this fireplace.

## Install Ceramic Logs

Unpack the ceramic logs very carefully to avoid damaging them. Install the logs as shown below. Please note that **the position of the logs is critical to insure proper performance of the appliance.**

**When placing the base and middle logs, rotate them a little bit to anchor them into position.**

1. Place the rear log on the back of the ember bed locating its right-hand end over the key in the ember bed. Slide the log back until it rests against the vertical sheet metal edge.

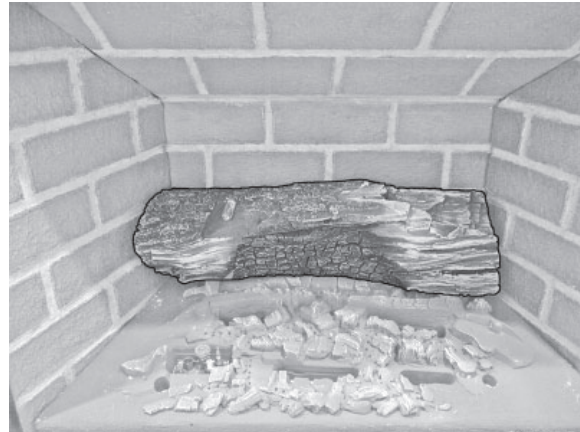
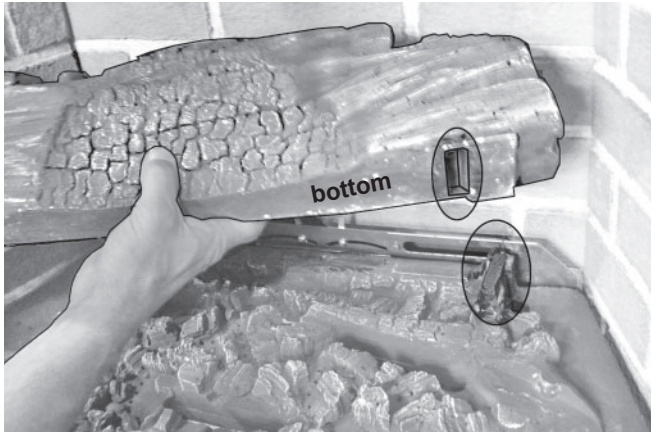

2. Place the left-hand middle log in front of the rear log locating it over the key in the ember bed as indicated. The flat part of the log sits on the platform. The key notch is at the back of the log.

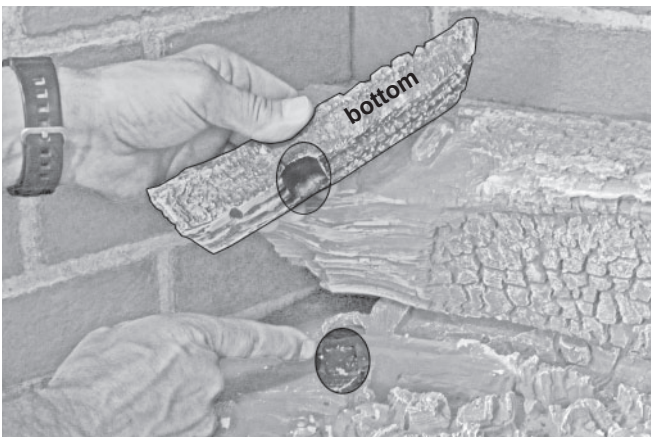

3. Place the left-hand base log on the platform locating it on the key as indicated. Move the log slightly forward so that it does not cover the pilot. However, do not cover the two burner holes at the front of the log.

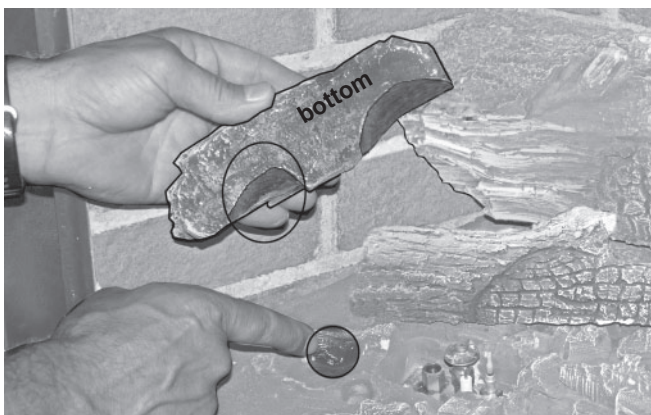

## Installation

4. Place the center base log locating its notch on the key in the ember bed as indicated. The darkened part of this log should be on the left side.

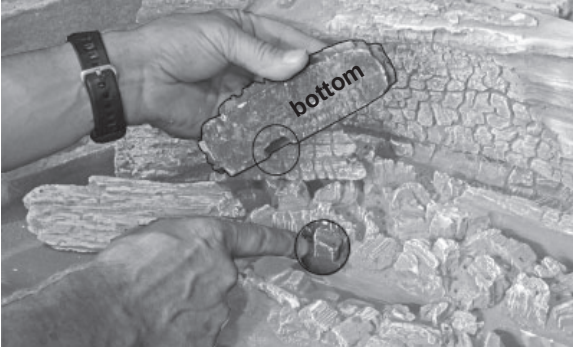

5. Place the right-hand base log locating its notch on the key in the ember bed as indicated.

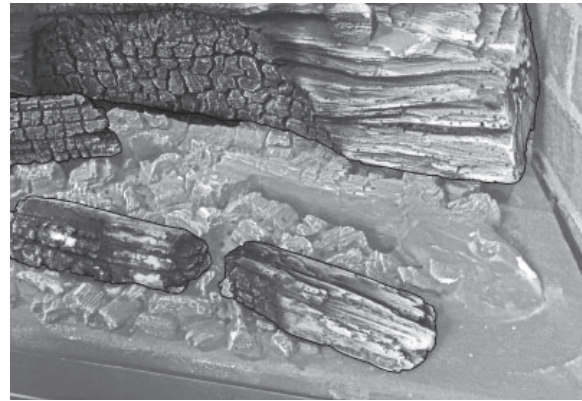
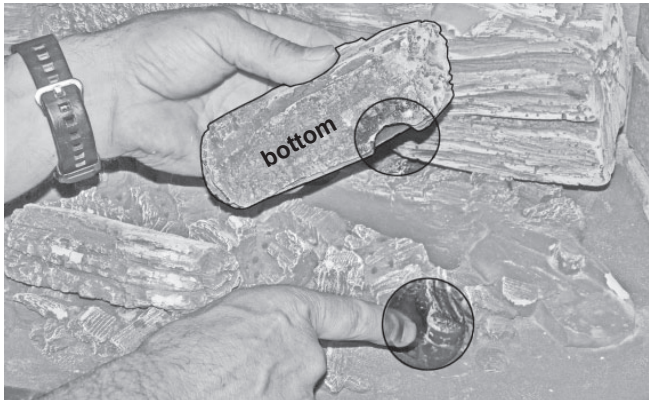

6. Place the right-hand middle log locating its notch on the key in the ember bed as indicated.

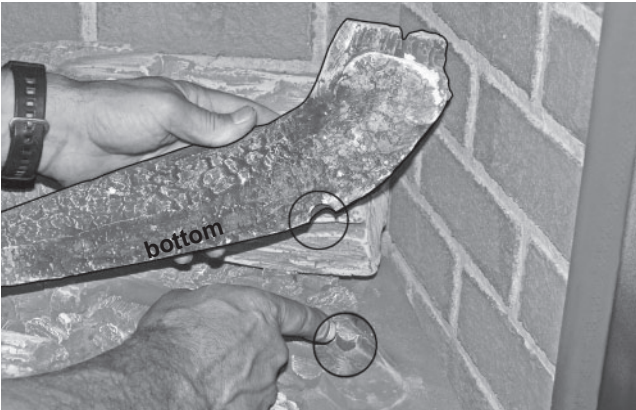

7. Place the left-hand cross log locating its notch on the key on the top of the rear log as indicated. Rest the front end of the log on top of the left base log as indicated.





8. Place the right-hand cross log locating its notch on the key on the top of the rear log as indicated. Rest the front end of the log centered on top of the center base log.

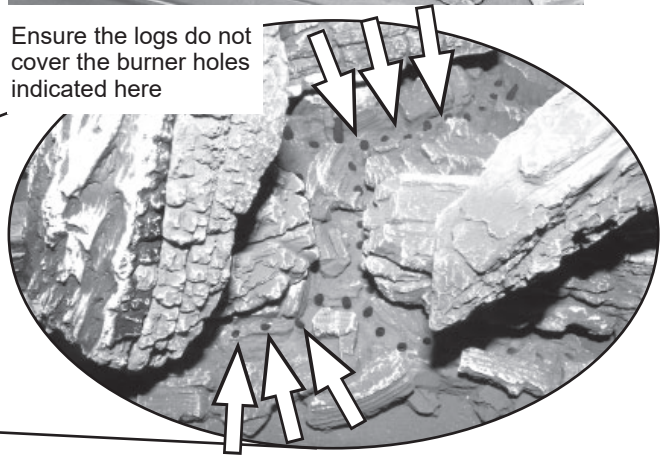
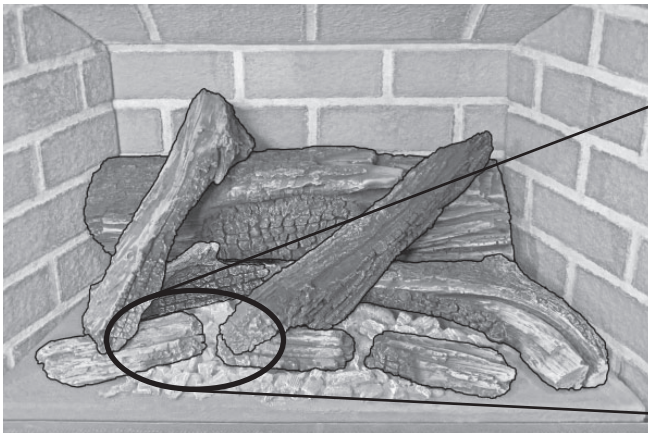

**Refit and Check Window**

1. Place the window in its bottom railing and push its top against the firebox. **Ensure to remove any particles in the railing before installing the window.**

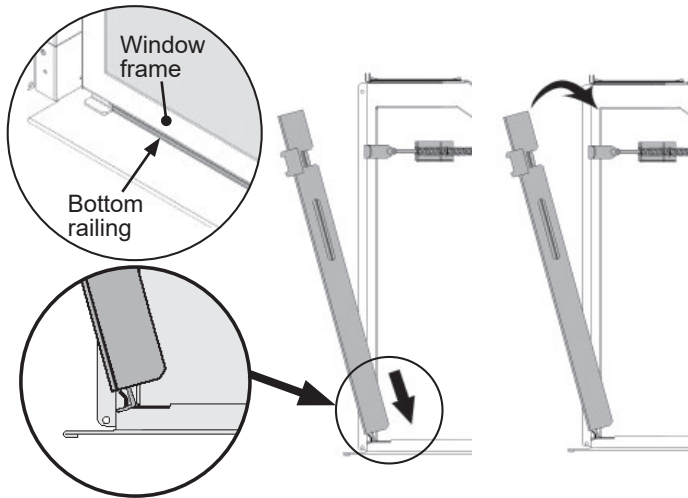

2. While you hold it, hook the side levers into the window tabs.

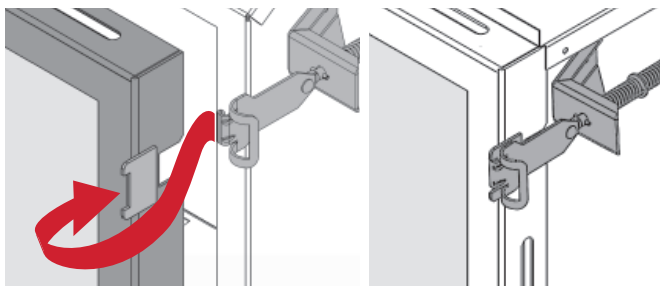

3. Pull out the top of the window and release it to ensure the springs return it.
4. Apply firm hand pressure around the window frame to ensure the window is sealed tight against the firebox.

**⚠ DANGER**

The window unit must be correctly installed, fastened and sealed after servicing or serious bodily injury and/or damage to the appliance may result.

To ensure a safe operation:

- Double-check that the bottom of the window frame is correctly installed in the bottom support railing;
- Verify that the levers are hooked properly to the window tabs then;
- Pull out the top of the window and release it to insure the springs return it;
- Ensure the window is sealed before operation.

**⚠ WARNING**

Failure to install the window correctly can leak carbon monoxide, affect the performance of the fireplace, damage components, cause overheating resulting in dangerous conditions. Damage caused by incorrect window installation is not covered by the Valor warranty.

5. If the Hot Glass Warning plate has been removed from the front lower corner of the window, reinstall it by sliding it between the glass and the frame as indicated below.

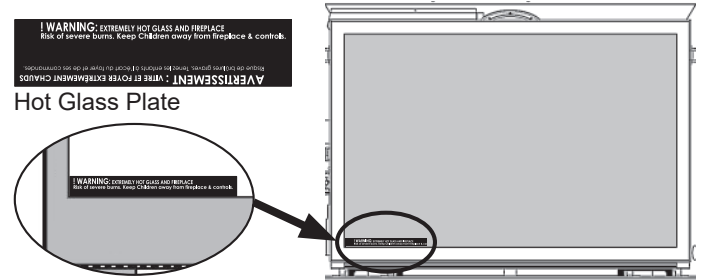

## Installation

### Synchronize Remote Control

The receiver and the handset of the remote control system must be initially synchronized before the first use.

1. Insert 4 x 1.5V alkaline batteries in the battery holder and 1 9V battery in the handset.



2. On the left hand side of the firebox, pull the loose wire that is already connected to the receiver and connect it to the battery holder. Place the battery holder to the left of the firebox, in front of the receiver.

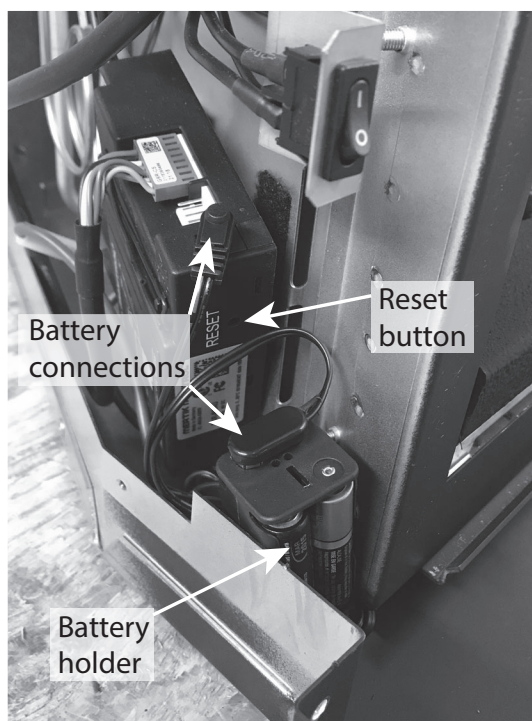
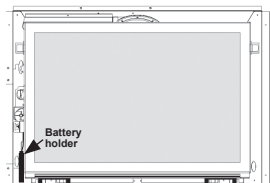

3. With a sharp object, press and hold the receiver's reset button until you hear one short and one long beep. Release the reset button after the second beep.
4. Within the subsequent 20 seconds, press the small flame button (🔥) on the remote handset until you hear two short beeps confirming the synchronization is set.

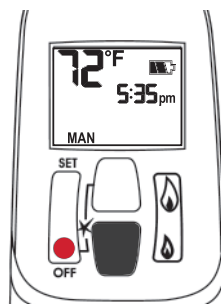

This is a one time setting only and is not required when changing the batteries in the remote handset. The remote control system is now ready to use.

## Installation

### Check Operation

Turn the fireplace flame up and down using the remote control to confirm that the full range of inputs is achieved—see the remote control operation instructions on pages 8–11.

### Adjust Aeration (if necessary)

Light the fire and allow the unit to warm up for 10–15 minutes to evaluate the flame picture. The burner is equipped with an adjustable shutter to control primary aeration. See the figures below. The shutter is factory-set to an aeration gap which will give optimum performance for the vast majority of installations.

Depending of fuel bed used, altitude and other considerations, the flame picture may be improved by adjusting the aeration. The need for adjustment should be determined only by operating the appliance with the fuel bed, liners and window installed and evaluating the flame picture after a 15-minute warm-up.

**Increasing aeration (open)** will cause the flames to appear more transparent and blue showing more ceramic effects glow.

**Decreasing aeration (close)** will cause the flames to appear more yellow or orange showing less ceramic effects glow.

**Too little aeration may result in black carbon forming and dropping into the firebox.**

**Note:** The image below shows how the air shutter works. Its position is for illustration purposes only and **DO NOT** necessarily represent how you should set it.

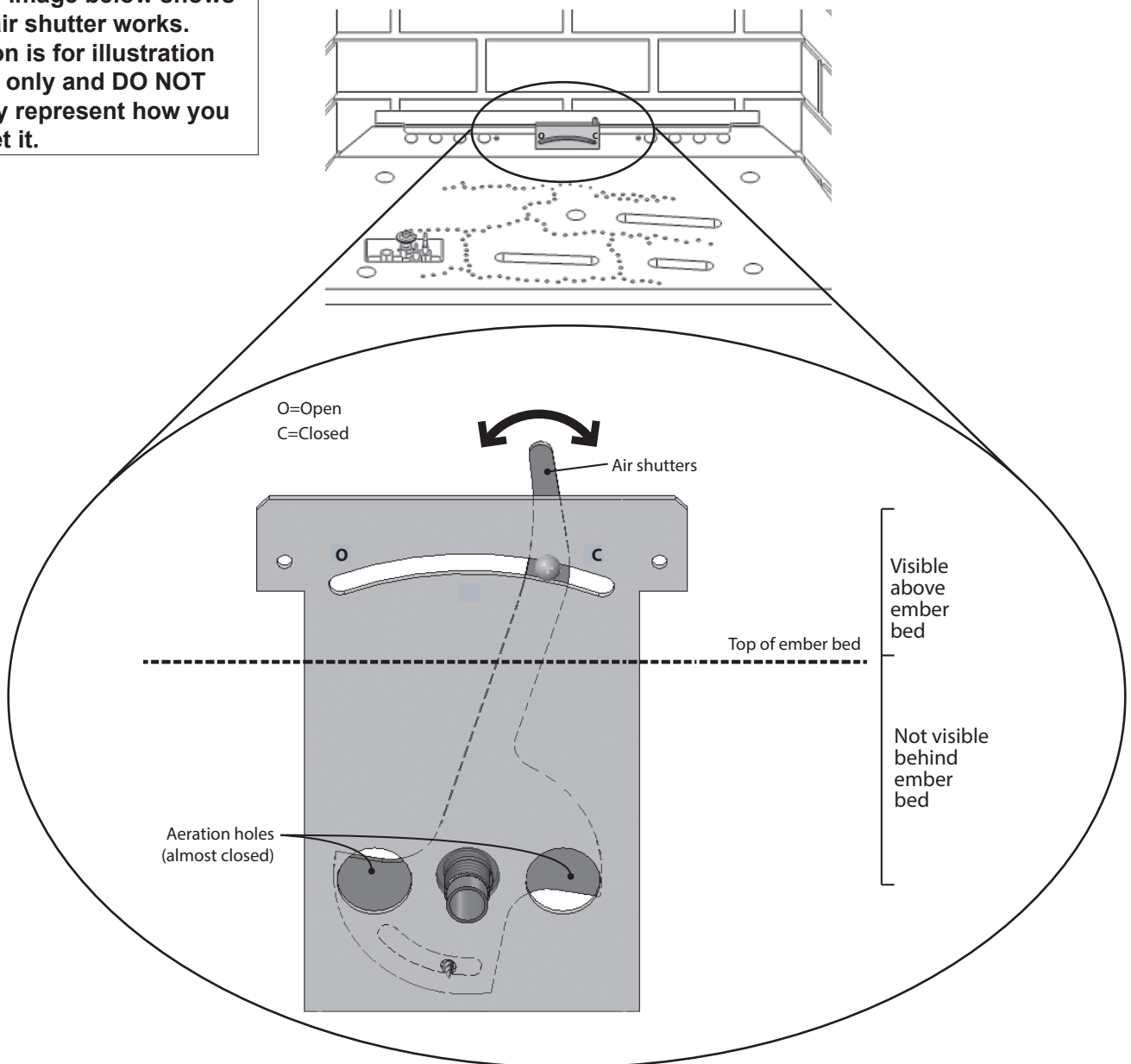

## Installation

### Install Side Shrouds

The side shrouds are required to install the front on the appliance. They are supplied with the engine. Fit them to the appliance outer case as indicated (2 screws/side).

See instructions supplied with the front trim for installation of trim.

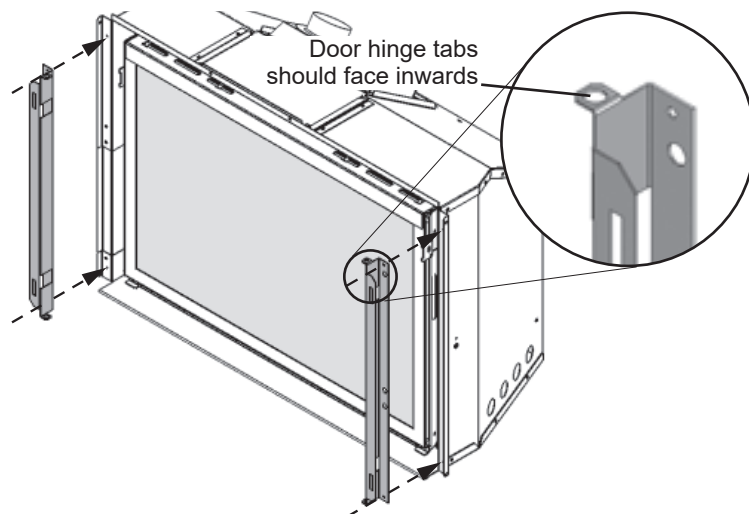

### Install Front, Trim and Barrier Screen

Install the front or trim chosen by the customer for their fireplace. Install as well the barrier screen which is provided with the front or trim.

Show the customer how to access the controls when the front or trim are installed and how to remove them.

Follow the instructions provided with the front or trim and leave those instructions behind for the customer's further reference.

### Install Handset Wall Holder

The remote control kit for this fireplace comes complete with a wall-mounted holder. This holder is not required in all installations but is provided as an optional feature for those customers who wish to mount the remote handset to the wall.

To install the holder to the wall, find a convenient location and use the hardware provided with the kit. See the diagram below for required hardware and configurations. Note that the holder can be installed at the base of a light switch plate.

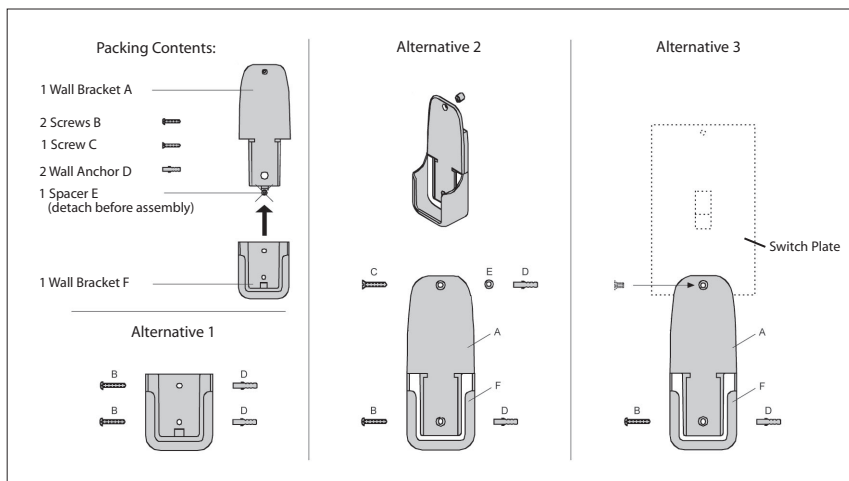

**IMPORTANT.** The location of the remote control handset is important to assure proper temperature regulation. To obtain a constant temperature, we recommend that the handset should be between 3 and 15 feet away from the appliance **but not directly above it**. We also advise that the handset should be located away from any other heat source and not in direct sunlight as this may affect the temperature sensor located in the remote handset.

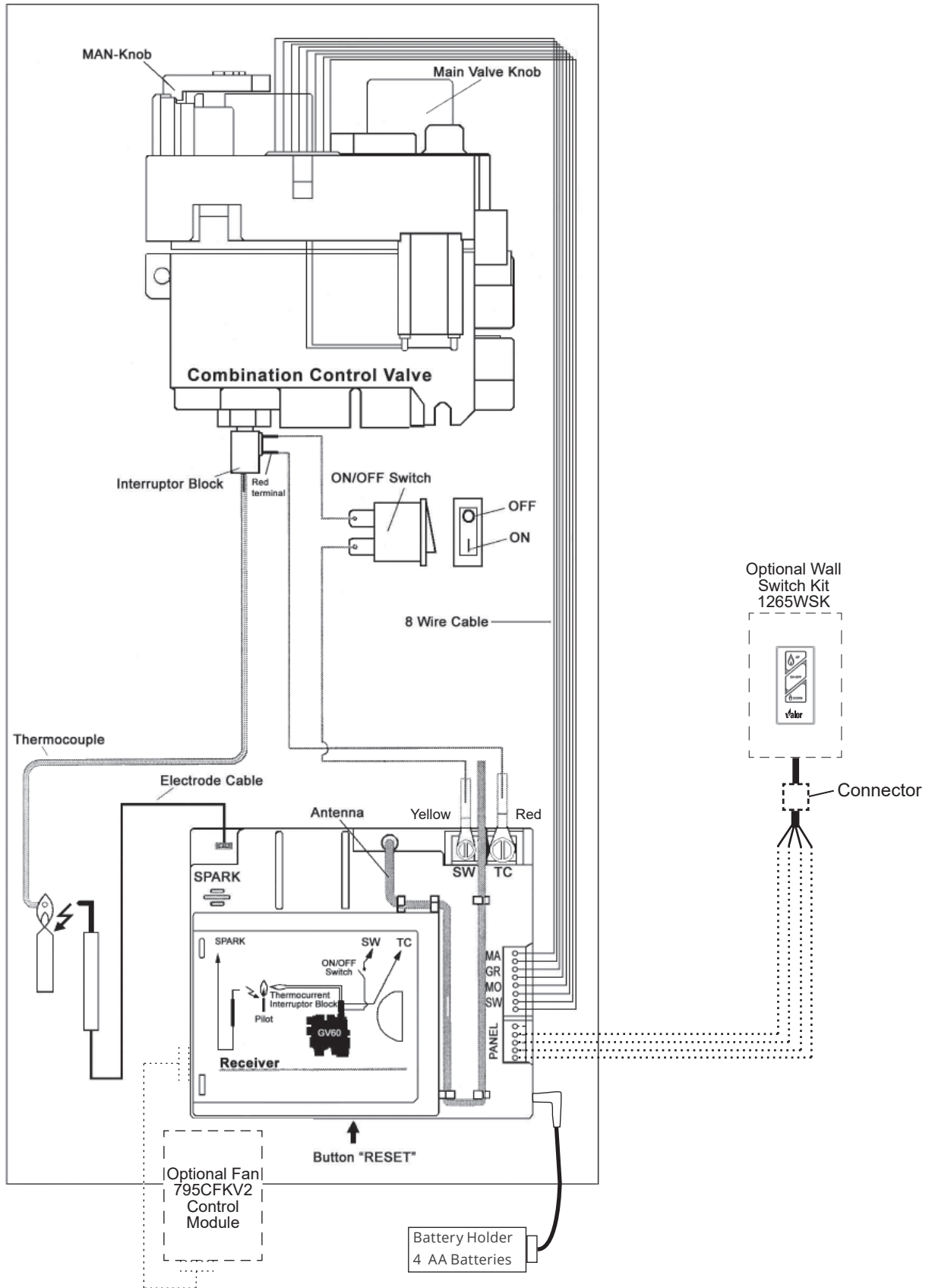

# Wiring Diagram



GV60 Wiring Diagram

# Approved Venting Components

**QUALIFIED  
INSTALLER**

Approved Direct Vent Suppliers for Valor Models 700 <sup>4</sup> , 739 <sup>3</sup> , 780 <sup>4</sup> and 785											
  Venting Parts Description		Venting Parts Code / availability by Manufacturer									
		DURA-VENT	SELKIRK	ICC EXCEL DIRECT	SECURE VENT	RLH INDUSTRIES	AMERIVENT	MILES INDUSTRIES	BDM		
Termination Caps	Vertical	Standard Co-axial	46DVA-VC	4DT-VT	—	—	HSDV4658-1313	4DVC	—	940264	
		High Wind Co-axial	46DVA-VCH	—	TM-4SVT	SV4CGV		—		—	—
		Extended Co-axial	46DVA-VCE	—	—	—		—		—	—
	Vertical	Co-linear	46DVA-CL33	—	TM-IVT	3PDVCV	HS-C33U-99	HCL-99-33	559CLT	940033B	
							HS-C33F-1313	HCL-913-33		940034B	
								HCL-1313-33		940033HWS	
Horizontal	—	—	—	—	—	—	720SWK <sup>3</sup> 720SWK-M <sup>3</sup> 720SWK-M2 <sup>4</sup>	—	940033RD		
Vent Adapters / Couplers	Universal Adapter 3" Flex Coupler	2150	—	TM-CFAA3	—	—	—	—	95090390		
	Co-linear Flex Connector	46DVA-ADF	—	—	—	—	—	—	—		
	Co-linear-to-Co-axial Adapter	46DVA-GK 46DVA-CLTA	—	TM-4CTA	—	—	4DCAT33	—	—		
Aluminum Flexible Liner	3" or 4" diameter	NOTE: 2-ply liner approved to CAN/ULC S635 suitable for venting gas appliances. As manufactured by Z-Flex, Flexmaster and others.									
		2280 Series	AF3-35L	TM-ALK33 TM-ALT33	—	—	—	—	952703 952704		
Flashings	Roof Flashing 0/12-6/12	46DVA-F6	4DT-AF6	TF-4FA	SV4FA	—	4DF (0/12-5/12)	—	949606012		
	Roof Flashing 7/12-12/12	46DVA-F12	4DT-AF12	TF-4FB	SV4B	—	4DF12 (6/12-12/12)	—	949606712		
	Flat Roof Flashing	46DVA-FF	—	TF-4F	SV4F	—	—	—	949606001		
	Masonry Flashing	—	—	TF-4MF	—	—	—	559FSK	—		

- Notes:**
1. Follow instructions supplied with each manufacturer's components.
  2. Termination caps manufactured by RLH Industries or American Metal Products are from Homestyle Chimney Collection and can be ordered in one of the following finishes: a) aluminum; b) black powder coated; c) solid copper.
  3. The 720SWK-M Sidewall Kit can only be installed on the 739M models; the 720SWK can be installed on the 739-72 models.
  4. The 720SWK-M2 Sidewall Kit can only be installed on the 700M and 780M models.

# Warranty

If you have a problem with this unit, please contact your dealer or supplier immediately. Under no circumstances should you attempt to service the unit in any way by yourself. The warranties in paragraphs 1 and 2 are provided only to the initial user of this unit, are not transferable and are subject to the conditions and limitations in paragraphs 3, 4 and 5. Please review the conditions and limitations carefully and strictly follow their requirements.

## 1. Extended Warranty Coverage

For a period of up to ten (10) years, Miles Industries Ltd., (the "Company") or its appointed distributor will at its option pay the initial owner for the repair of, or will exchange the following parts or components which are found to be defective in material or workmanship under normal conditions of use and service:

Maximum Warranty Period		10 years
Part or Component	Defect Covered	
Exterior steel casing	Corrosion	✓
Glass	Loss of structural integrity	✓
Cast iron parts	Corrosion	✓
Firebox and heat exchanger	Corrosion (but not discoloration) causing loss of structural integrity	✓

## 2. Two-Year Parts Warranty

In addition, for two (2) years from the date of purchase, the Company, at its option, will repair or exchange all parts and components not listed above but that are found to have a bona fide defect in material or workmanship under normal conditions of use.

## 3. Conditions and Limitations

- a) The warranty registration card must be completed by the initial owner and returned to the company within 90 days. Alternatively, the warranty registration form may be filled out online at [www.valorfireplaces.com](http://www.valorfireplaces.com)
- b) Installation and maintenance must be performed by an authorized and trained dealer in accordance with the Company's installation instructions.
- c) This warranty is void where installation of the unit does not conform to all applicable codes including national and local gas appliance installation codes and building and fire codes.
- d) The owner must comply with all operating instructions.
- e) The Company is not responsible for the labor costs to remove defective parts or re-install repaired or replacement parts.
- f) The initial owner of the unit will be responsible for any shipping charges for replacement parts as well as travel time incurred by the dealer to perform the warranty work.

- g) This warranty applies to non-commercial use and service and is void if it is apparent that there is abuse, misuse, alteration, improper installation, accident or lack of maintenance to the unit.
- h) The warranty does not cover damage to the unit through:
  - i) Improper installation, operational or environmental conditions.
  - ii) Inadequate ventilation in the area or competition for air from other household equipment or appliances.
  - iii) Chemicals, dampness, condensation, or sulphur in the fuel supply lines which exceeds industry standards.
- i) This warranty does not cover glass, log breakage or damage to the unit while in transit.
- j) The Company does not allow anyone to extend, alter or modify this warranty and assumes no responsibility for direct, indirect or consequential damages caused by the unit. State or provincial laws where the initial user or user resides may provide specific rights extending this warranty and, if so, the Company's sole obligation under this warranty is to provide labor and/or materials in accordance with those laws.

## 4. Discharge of Liability

After two (2) years from the date of purchase, the Company may, at its option, fully discharge all obligations under this warranty by paying to the first owner the wholesale price of, or replacing, any defective parts.

## 5. No Other Warranty

All obligations to repair this unit are defined in this warranty. Some states or provinces may specifically mandate additional obligations on the part of manufacturers, but in the absence of such specific legislation, there is no other warranty or obligation expressed or implied.



# Spare Parts

	Description	Part Number
1	AutoFire Exhaust slide assembly	4006540
2	Exhaust Slide Gasket	4001662
3	Valve access cover	4002289
4	Side brick anchors (2)	4001283
5	LH Explosion relief assembly	4001286
6	RH Explosion relief assembly	4001287
7	Access panel gasket	4002664
8	Access plate	4002510
9	Shrouds (2)	4002446
10	Window frame assembly (inc. glass)	4004463S
11	Hot glass warning plate	4003093
12	Ceramic burner platform	4004044
13	Burner module assembly (natural gas)	4006261S
	Burner module assembly (propane gas)	4004046S
14	Top gasket	4002403
15	Side gaskets (2)	4002404
16	Bottom gasket	4002405
17	Thermocouple/pilot sealing plate	4002700
18	Single pipe sealing plate	4004338
19	Air shutter	4002590
20	Injector elbow #850 (natural gas)	9730010
	Injector elbow #300 (propane gas)	9730035
21	Injector nut	420K464
22	Pilot Shield	4003018AH
23	Pilot Assembly (natural gas)	4001690
	Pilot Assembly (propane gas)	4001691
24	Thermocouple	4000061
25	Pilot Injector #51 (natural gas)	4000735
	Pilot Injector #30 (propane gas)	4000736
26	Pilot Hood 2 Flame	4000730
27	Extended Nut	4001855
28	Electrode	4001856
29	Main burner pipe assembly	4004047
30	Thermocouple interrupter	4001037
31	GV60 valve assembly (natural gas)	4006260S
	GV60 valve assembly (propane gas)	4004284S
32	3/6" flex pipe	4002475
33	Ignition Cable	4001039
34	Insulation sleeve for ignition cable	4002244
35	Switch with Cable	4001036
36	Cable Interrupter	4001035
37	Receiver MAX (GX)	4002422
38	Wiring Harness	4001187

	Description	Part Number
39	Auxiliary battery holder & cable	
a	Battery holder	4006553
b	Battery holder cable 1500 mm	4006552
40	Handset GV60 MAX	4002251
41	Remote Control Wall Holder	9000008
42	Log Set Complete	4004043
43	RH middle log	4002683
44	RH base log	4002685
45	Center base log	4002686
46	LH base log	4002684
47	LH middle log	4004052
48	LH cross log	4004050
49	Rear log	4004051
50	RH cross log	4004049
51	Liner panels—complete set	
a	Ledgestone	786LSLV3
b	Reflective glass	787RGL
c	Ceramic fluted black	788FBLV2
d	Valor red brick	789VRLV2
52	Top panel	
a	Ledgestone	4007997
b	Ceramic black	4002374
c	Ceramic black	4002374
d	Valor red brick	4002385
53	Rear panel	
a	Ledgestone	4008000
b	Reflective glass	4004707
b	Rear filler panel	4004799
c	Ceramic fluted black	4004268
d	Valor red brick	4004266
54	Left side panel	
a	Ledgestone	4007998
b	Reflective glass	4004708
b	Filler panel	4002776
c	Ceramic fluted black	4002377
d	Valor red brick	4002382
55	Right side panel	
a	Ledgestone	4007999
b	Reflective glass	4004709
b	Filler panel	4002776
c	Ceramic fluted black	4002378
d	Valor red brick	4002383
56	GV60 Valve repair kit	4004544
57	2.5-4.5" hose clamp (2)	4000768

# Spare Parts

