

G3.5 + G4

Inserts with AutoFire™



TWO DECADES
OF LEGENDARY HEAT.



Radiant
Gas Fireplaces

THE SCIENCE OF WARMTH™

Since 1890, we've been pioneering and perfecting radiant heat technology that generates constant, comfortable warmth within your home.

RADIANT HEAT

What makes Valor unique? We put radiant heat technology into every fire. You can feel it.

AUTOFIRE™

Pioneered by Valor, AutoFire automatically adjusts the fire for optimum efficiency and enjoyment.

EFFICIENCY

Radiant zone heating is up to 25% more efficient than central forced air systems.

REMOTE CONTROL

Adjustable flame for constant, even warmth without having to cycle the fire on and off—or leave the sofa.

SAFETY

Our fires are put through rigorous safety testing in our in-house CSA approved lab.

REALISTIC LOGS

High definition, low mass fiber ceramic logs heat up and glow quickly, radiating warmth.

COVER:
G3.5 700M
BIRCH 700BLK
LEDGESTONE 705LSLV3
EDGEMONT CRAFTSMAN PEWTER 716ECPW
EDGEMONT 3-SIDED FLAT BACKING PLATE 717BPBF

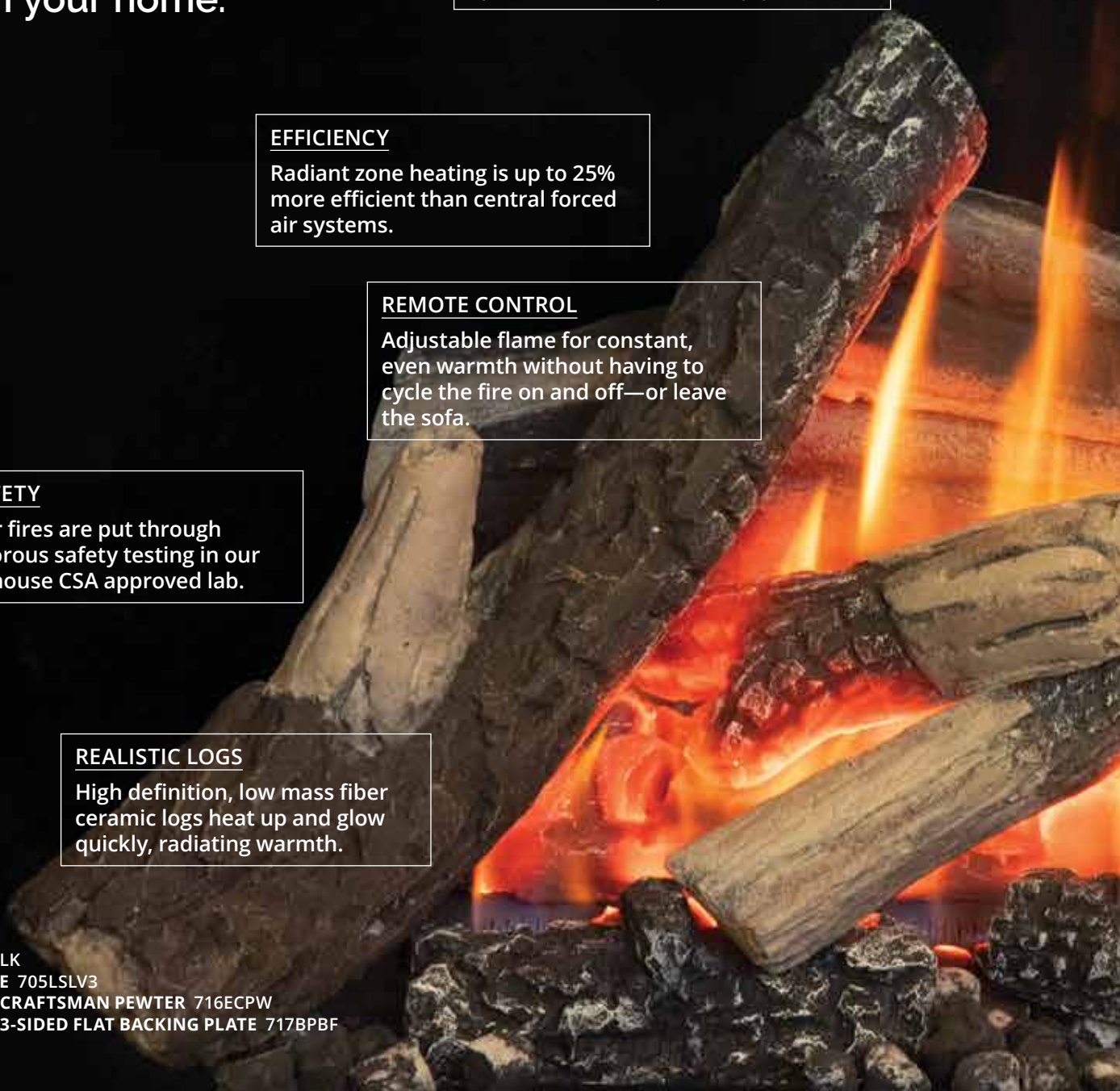



CONVECTIVE HEAT

Secondary Heat Exchanger naturally improves convective heat—without a fan.

V-CLASS BURNER

Our precision stainless steel V-Class burner creates an enhanced flame and ember glow.

NO POWER. NO PROBLEM.

Valor fireplaces heat without electricity—even in a power failure.

CERAMIC GLASS

Durable and robust ceramic glass improves radiant performance.

SUPERIOR ALUMINIZED STEEL

Aerodynamic aluminized steel firebox handles high temperatures, delivering efficient radiant warmth.

Please Note: Printed images may vary from actual product. All product information is accurate at time of printing and is subject to change. For more information, visit valorfireplaces.com

**PROUDLY MADE
IN NORTH AMERICA**

INSERT GAS FIREPLACES

Old wood fireplaces are highly inefficient heaters. Replace yours with a gas insert for an air-sealed, energy efficient and easy-to-use source of home comfort.



G4 780M
BIRCH 1000BLKV2
REFLECTIVE GLASS LINER 787RGL
4" VINTAGE IRON FLOATING FRONT 792FTV

1 LOGS

We design all our expertly crafted logs as realistic-looking as possible, and engineer them to harness radiant heat from the flames and glowing embers.



BIRCH



TRADITIONAL LOGS



DRIFTWOOD



The G3.5 and G4 fire beds may have slight differences in appearance.
To view them separately, go to valorfireplaces.com



PEBBLE BEACH DRIFTWOOD



MURANO GLASS

To see in person, visit your local Valor dealer. Or scan the code for photos and videos of the fuel beds:



TIP

Liners can appear quite different with the fire on compared to a natural light setting.



G3.5 700M
BIRCH 700BLK
FLUTED BLACK LINER 707FBL
EDGEMONT BRONZE FRONT 721EDZ
EDGEMONT 3-SIDED BACKING PLATE 717BPB

FLUTED BLACK

2

LINERS

Choose a firebox liner to complement the logs and front style you select as well as the surround of your current fireplace.

Please note the tint of the ceramic glass window can warm the liner colors, especially when the fire is on. If possible, visit your local Valor dealer to see a sample in person.

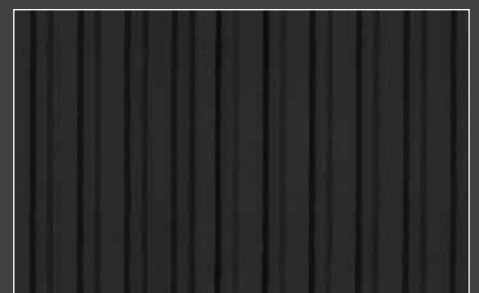



REFLECTIVE GLASS

LEDGESTONE

BRICK





G3.5 700M
 TRADITIONAL LOGS 700LSK
 REFLECTIVE LINER 706RGL
 EDMONT BRUSHED NICKEL FRONT 721EDN
 EDMONT 3-SIDED BACKING PLATE 717BPB

3 FRONTS

Select a front that suits your home and style. Your dealer can help you choose, if necessary, a backing plate to complement your front that fits your installation. For more images, visit valorfirerplaces.com/gas-fireplace-inserts

EDGEMONT FRONTS

Edgemont fronts are slightly offset from the required backing plate.



CRAFTSMAN PEWTER



CRAFTSMAN BRONZE



CRAFTSMAN BRASS



BRUSHED NICKEL



BRONZE



VINTAGE IRON
(G3.5 ONLY)



FLOATING

Floating fronts sit proud by 1½" of the wall or the optional backing plate.



4-SIDED VINTAGE IRON 4"
ALSO AS 3-SIDED



4-SIDED BLACK 4"
ALSO AS 3-SIDED
(G3.5 ONLY)

G4 SQUARE

Square fronts are 1¾ deep.



SQUARE BLACK 5.75"
ALSO IN VINTAGE IRON



VINTAGE IRON 2.5"
(G4 ONLY)



3-SIDED BRONZE 4"



G4 780M
DRIFTWOOD 1000DWKV2
LEDGESTONE 786LSLV3
FLOATING 4-SIDED FRONT 798FFV

4 FINISHES

You can see the craftsmanship in our fronts. Made of steel and then powder-coated, or plated with an artisan touch—both offer durable, long-lasting finishes. If possible, visit your local Valor dealer to see a finish in person.

EDGEMONT CRAFTSMAN FRONTS

CHAMPAGNE BRASS



BRONZE



PEWTER





BLACK

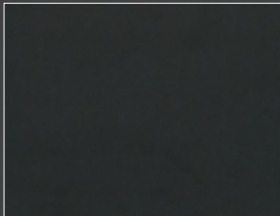

VINTAGE IRON

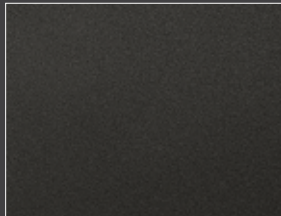

BRONZE



BRUSHED NICKEL





G4 780M
DRIFTWOOD 1000DWKV2
REFLECTIVE GLASS LINER 787RGL
EDGEMONT NICKEL FRONT 799EDFN
EDGEMONT BACKING PLATE 717BPBF



REMOTE CONTROL

VALOR REMOTE—STANDARD

Every Valor fireplace comes with a remote. Your remote lets you select, adjust or program your desired temperature—the fire automatically adjusts to maintain

the temperature of the room. Your remote even allows you to turn your pilot light on or off from the comfort of your sofa. To find out more about the G4 remote, visit valorfireplaces.com/remote





EFFICIENCY

We use recognized government testing methods to determine our energy efficiencies, and ensure our products perform in your home as rated.

FUEL BTU/HR

	MODEL	FUEL	MAX. INPUT	MIN. INPUT	MAX. OUT*
G3.5	700M	natural gas	26,000	13,000	20,933
		propane	26,000	11,000	20,933
	700X	NG/PG	24,000	13,000	17,825
	780M	NG/PG	28,000	14,000	20,993
G4	785Y	natural gas	28,000	15,000	20,664
		propane	26,000	13,000	19,344

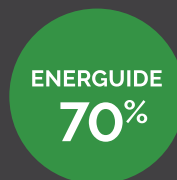

* EnerGuide Ratings and Outputs have been determined without a fan/blower, using the CSA P4.1-15 test method. Certified to ANSI Z21.88/ CSA 2.33 Vented Gas Fireplace Heater American National Standard. CGA — 2.17-91 Gas Fired Appliances for use at High Altitudes.

Find out more at valorfireplaces.com/efficiency

EDGEMONT BACKING PLATES

All Edgemont fronts, including Craftsman, require Edgemont backing plates, available in 3 and 4-sided styles and different thicknesses. The fronts are slightly offset from the backing plate. See below.

G3.5



Backing plate:
1½" thick

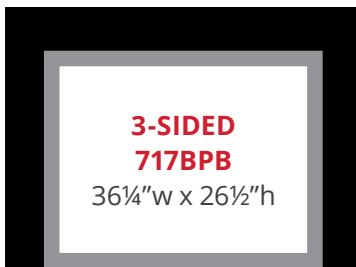

Backing plate:
½" thick.

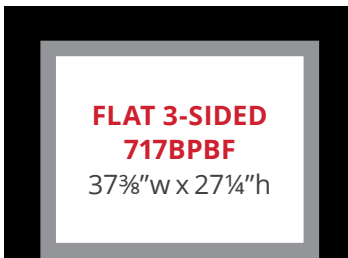

G4



Backing plate:
½" thick.

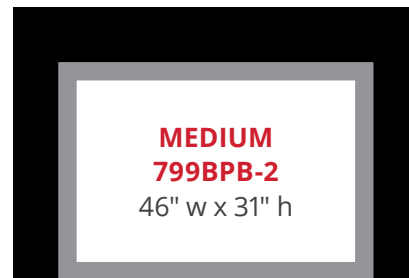
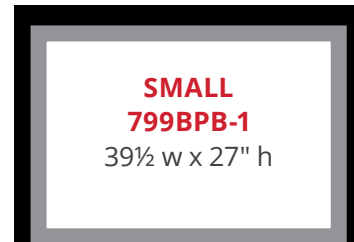
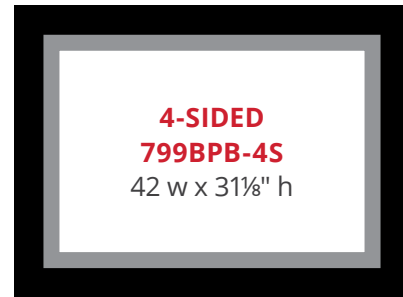

BACKING PLATES FOR FLOATING FRONTS

The flat backing plates below are .5" thick and pair with 3-sided Floating fronts. The G3.5 backing plates may also be used with G3.5 Edgemont backing plates to cover a larger opening.

G3.5



The Floating fronts sit proud of the flat backing plates by 1.5".

G4



The Floating fronts sit proud of the flat backing plates by 1.5".

OR

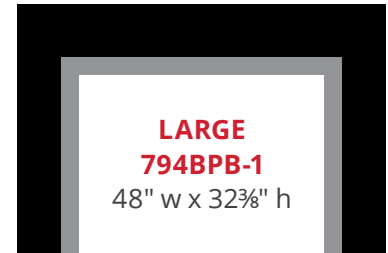
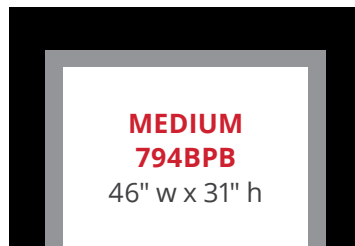
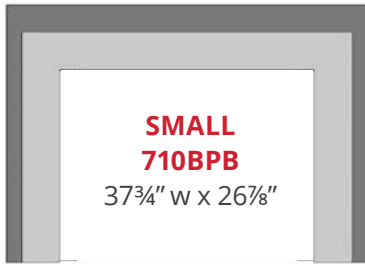

SHOWN WITH 2.5" FLOATING FRONT

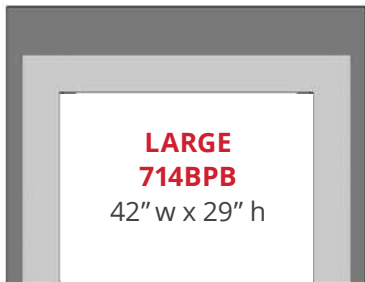

SHOWN WITH 5" FLOATING FRONT

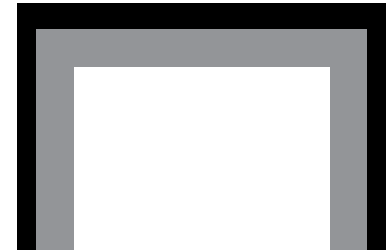

SHOWN WITH 5³/₄" SQUARE FRONT

DIMENSIONS

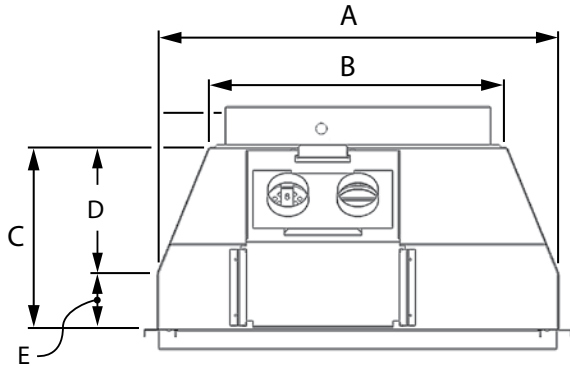

	G3.5	G4
A	28 ⁵ / ₈ "	33"
B	21 ¹ / ₄ "	24"
C	13"	15"
D	9"	11"
E	4"	4"
F	9 ¹ / ₂ "	9 ¹ / ₂ "
G	20"	23"

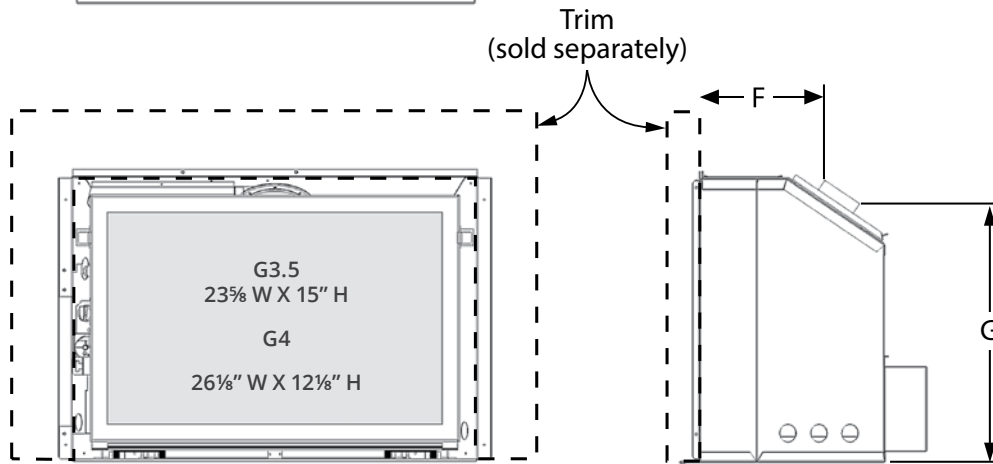

MINIMUM CAVITY DIMENSIONS

G3.5

	WITH ALL BACKING PLATES EXCEPT 717BPBF
depth (X)	13 ¹ / ₂ "
depth (X) with fan	16 ¹ / ₂ "
height (Y)	20 ¹ / ₂ "
width* (not shown)	28 ⁷ / ₈ "

WITH 717BPBF (FLAT PLATE)

depth (X)	14 ¹ / ₂ "
depth (X) with fan	17 ¹ / ₂ "
height (Y)	22 ³ / ₈ "
width* (not shown)	30 ⁷ / ₈ "

ALL BACKING PLATES EXCEPT EDMONT

G4

	standard install	w/ leveling platform	w/ fan
depth (X)	15 ¹ / ₂ "	16"	18 ¹ / ₂ "
height (Y)	23 ¹ / ₄ "	23 ¹ / ₄ "	23 ¹ / ₄ "
width* (not shown)	33 ¹ / ₄ "	33 ¹ / ₄ "	33 ¹ / ₄ "

WITH EDMONT TRIM

	no fan	w/ fan
depth (X)	16 ³ / ₄ "	19 ³ / ₄ "
height (Y)	23 ¹ / ₄ "	23 ³ / ₄ "
width* (not shown)	35 ³ / ₄ "	35 ³ / ₄ "

*Minimum fireplace opening

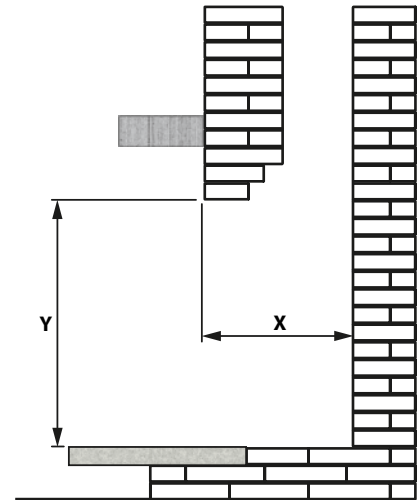

Note: Raise the G3.5 appliance by 2⁵/₈" when using the 719BPB 4-Sided Backing Plate as the plate extends below the bottom of appliance.

G4 Edgemont trims—799 and 784—require a larger and deeper cavity. See manual.

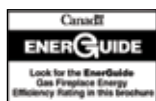
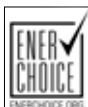

Designed and manufactured by
Miles Industries Ltd.
Copyright Miles Industries Ltd. 2023

MANTEL CLEARANCES

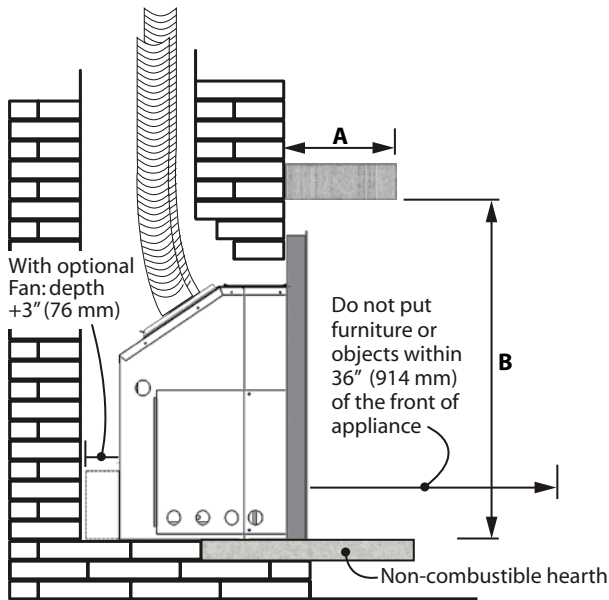

G3.5

Mantel Projection A	0 - 6"	8"	10"	12"
Mantel Height B*	33"	35"	37"	39"

G4

Mantel Projection A	1"	4"	8"	14"
Mantel Height B*	34"	36"	38"	40"

* Measured from underside of mantel to finished hearth or surface that unit sits on.

VENTING

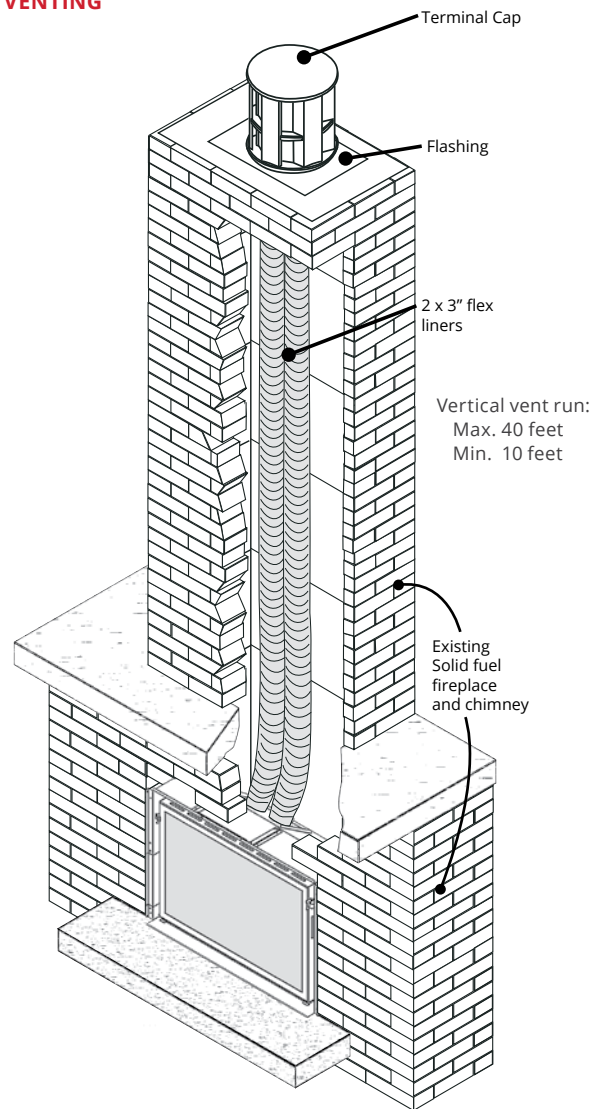

ALWAYS REFER TO THE MANUAL FOR COMPLETE AND ACCURATE INSTALLATION INSTRUCTIONS.
valorfireplaces.com/manuals

G3.5
HOMEOWNER



G3.5
INSTALLER



G4
HOMEOWNER



G4
INSTALLER





G4 780M
TRADITIONAL LOGS 1000LSKV2
FLUTED BLACK LINER 788FBLV2
FLOATING 3-SIDED FRONT 792FTV

OPTIONS

DIRECT VENT

	<u>G3.5</u>	<u>G4</u>
V-Class Stainless Steel Burner: Natural Gas or Propane	700M	780M
Ceramic Burner: Natural Gas or Propane	700X	785Y

1 FUEL BED

V-Class Birch	700BLK	1000BLKV2
V-Class Traditional logs	700LSK	1000LSKV2
V-Class Driftwood	700DWK	1000DWKV2
Pebble Beach Driftwood	700XDWK	1101DWK
Murano Glass	700XDGM	785XDGM

2 LINER

Ledgestone	705LSLV3	786LSLV3
Fluted Black	707FBL	788FBLV2
Reflective Glass	706RGL	787RGL
Red Brick	708VRL	789VRLV2

3 FRONT

EDGEMONT

Brushed Nickel	721EDN	799EDFN
Vintage Iron	721EDV	
Bronze	721EDZ	799EDFZ
Craftsman Champagne Brass	716ECCB	784ECCB
Craftsman Pewter	716ECPW	784ECPW
Craftsman Bronze	716ECBR	784ECBR

FLOATING, 3-SIDED

Vintage Iron 2.5"		790FTV
Black	709FTB	
Brushed Nickel	709FTP	
Vintage Iron	709FTV	792FTV
Bronze	709FTZ	792FTZ

FLOATING, 4-SIDED

Black	713FFB	
Vintage Iron	713FFV	798FFV

SQUARE, 3-SIDED, 5.75"

Vintage Iron		791STV
Black		791STB

RISER

Black, small	725RTB		40"w x 2½"h
Black, large	793RTB	793RTB	46¼"w x 2½"h
Vintage Iron, large	793RTV	793RTV	46¼"w x 2½"h

CHOOSE A BACKING PLATE:

REQUIRED EDGEMONT BACKING PLATE

3-SIDED

717BPB (G3.5)
717BPBF (G3.5)
799BPB-1 (G4)
799BPB-3 (G4)
799BPB-2 (G4)

+

4-SIDED

719BPB (G3.5)
799BPB-4S (G4)

or

OPTIONAL FLOATING BACKING PLATE

3-SIDED, SMALL

710BPB (G3.5)
794BPB (G4)

+

3-SIDED, LARGE

714BPB (G3.5)
794BPB-1 (G4)

or

Use these G3.5 backing plates with G3.5 backing plate 717BPB to cover larger openings.

⚠ WARNING

This product can expose you to chemicals including Benzene, which is known to the State of California to cause cancer and birth defects or other reproductive harm.

For more information go to www.P65Warnings.ca.gov

Note: Natural gas, in its original state, contains Benzene.

Risers fit specific fronts and backing plates. See manual.

G3.5 700X
PEBBLE BEACH DRIFTWOOD 700XDWK
FLUTED BLACK LINER 707FBL
EDGEMONT VINTAGE IRON FRONT 721EDV
FLOATING 4-SIDED BACKING PLATE 719BPB

